

# ROLEX

## ROLLED RINGS

### ROLEX RINGS LIMITED

Our Company originally started as a business in partnership under the name of 'Rolex Industries' by two of our Promoters Rupesh Dayashankar Madeka and Manesh Dayashankar Madeka in 1977-1978. The partnership firm was, thereafter, converted into a joint stock company under the Companies Act, 1956, in the name of 'Rolex Rings Private Limited', and a certificate of incorporation dated February 13, 2003 was issued by the RoC. The name of our Company was further changed to Rolex Rings Limited upon conversion to a public limited company and consequently a fresh certificate of incorporation was issued by the RoC, on March 10, 2021, recording the change of our Company's name to 'Rolex Rings Limited'. For details of changes in the name and registered office address of our Company, see 'History and Certain Corporate Matters' on page 131.

**Registered Office:** B/h. Glowtech Steel Private Limited, Gondal Road, Kotharia, Rajkot, Gujarat 360 004

**Corporate Office:** Near Kotharia Railway Crossing, opposite Hotel Krishna Park, Gondal Road, Kotharia, Rajkot, Gujarat 360 004

**Contact Person:** Hardik Dhimanbhai Gandhi, Company Secretary and Compliance Officer for the Offer; **Tel.:** 0281 6699677/577

**E-mail:** compliance@rolexrings.com; **Website:** www.rolexrings.com; **Corporate Identity Number:** U28910GJ2003PLC041991

PROMOTERS OF OUR COMPANY: RUPESH DAYASHANKAR MADEKA, JITEN DAYASHANKAR MADEKA, MANESH DAYASHANKAR MADEKA, PINAKIN DAYASHANKAR MADEKA AND BHAUTIK DAYASHANKAR MADEKA			
<b>INITIAL PUBLIC OFFERING OF 8,122,222 EQUITY SHARES OF FACE VALUE OF ₹ 10 EACH ("EQUITY SHARES") OF ROLEX RINGS LIMITED (OUR "COMPANY" OR THE "ISSUER") FOR CASH AT A PRICE OF ₹ 900 PER EQUITY SHARE INCLUDING A SECURITIES PREMIUM OF ₹ 890 PER EQUITY SHARE (THE "OFFER PRICE") AGGREGATING TO ₹ 7,310 MILLION (THE "OFFER"). THE OFFER COMPRISES OF A FRESH ISSUE OF 622,222 EQUITY SHARES BY OUR COMPANY AGGREGATING TO ₹ 560 MILLION (THE "FRESH ISSUE") AND AN OFFER FOR SALE BY RIVENDELL PE LLC, (THE "SELLING SHAREHOLDER"), OF 7,500,000 EQUITY SHARES AGGREGATING TO ₹ 6,750 MILLION ("THE OFFER FOR SALE"). THE OFFER SHALL CONSTITUTE 29.82% OF THE POST-OFFER PAID-UP EQUITY SHARE CAPITAL OF OUR COMPANY.</b>			
The Offer was made in terms of Rule 19(2)(b) of the Securities Contracts (Regulation) Rules, 1957, as amended ("SCRR") read with Regulation 31 of the Securities and Exchange Board of India (Issue of Capital and Disclosure Requirements) Regulations, 2018, as amended ("SEBI ICDR Regulations"). The Offer was made through the Book Building Process in accordance with Regulation 6(1) of the SEBI ICDR Regulations, wherein not more than 50% of the Offer was available for allocation on a proportionate basis to Qualified Institutional Buyers ("QIB Portion"), and our Company and the Selling Shareholder in consultation with the BRLMs allocated 60% of the QIB Portion to Anchor Investors, on a discretionary basis. One-third of the Anchor Investor Portion was reserved for domestic Mutual Funds, subject to valid Bids being received from domestic Mutual Funds at or above the Anchor Investor Allocation Price. Further 5% of the Net QIB Portion was available for allocation on a proportionate basis to Mutual Funds only and the remainder of the Net QIB Portion was available for allocation on a proportionate basis to all QIB Bidders including Mutual Funds, subject to valid Bids being received at or above the Offer Price. However, if the aggregate demand from Mutual Funds would have been less than 5% of the QIB Portion, the balance Equity Shares available for allocation in the Mutual Fund Portion would have been added to the remaining QIB Portion for proportionate allocation to QIBs. Further, not less than 15% of the Offer was available for allocation on a proportionate basis to Non-Institutional Bidders and not less than 35% of the Offer was available for allocation to Retail Individual Bidders in accordance with the SEBI ICDR Regulations, subject to valid Bids being received from them at or above the Offer Price. All potential Bidders (except Anchor Investors) were mandatorily required to utilise the Application Supported by Blocked Amount ("ASBA") process providing details of their respective ASBA accounts and UPI ID (in case of RIBs), if applicable, in which the corresponding Bid Amounts would have been blocked by the SCSBs or under the UPI Mechanism, as applicable. Anchor Investors were not permitted to participate in the Offer through the ASBA process. For details, see "Offer Procedure" on page 280.			
<b>RISKS IN RELATION TO FIRST OFFER</b>			
This being the first public issue of our Company, there has been no formal market for the Equity Shares. The face value of the Equity Shares is ₹ 10. The Offer Price/Floor Price/Cap Price, as determined and justified by our Company and the Selling Shareholder in consultation with the BRLMs in accordance with the SEBI ICDR Regulations and as stated in "Basis for Offer Price" on page 87 should not be taken to be indicative of the market price of the Equity Shares after such Equity Shares are listed. No assurance can be given regarding an active and/or sustained trading in the Equity Shares nor regarding the price at which the Equity Shares will be traded after listing.			
<b>GENERAL RISKS</b>			
Investments in equity and equity-related securities involve a degree of risk and investors should not invest any funds in this Offer unless they can afford to take the risk of losing their entire investment. Investors are advised to read the risk factors carefully before taking an investment decision in this Offer. For taking an investment decision, investors must rely on their own examination of the Issuer and this Offer, including the risks involved. The Equity Shares have not been recommended or approved by the Securities and Exchange Board of India ("SEBI"), nor does SEBI guarantee the accuracy or adequacy of the contents of this Prospectus. Specific attention of the investors is invited to "Risk Factors" on page 22.			
<b>COMPANY AND SELLING SHAREHOLDER'S ABSOLUTE RESPONSIBILITY</b>			
Our Company, having made all reasonable inquiries, accepts responsibility for and confirms that this Prospectus contains all information with regard to our Company and this Offer, which is material in the context of this Offer, that the information contained in this Prospectus is true and correct in all material aspects and is not misleading in any material respect, that the opinions and intentions expressed herein are honestly held and that there are no other facts, the omission of which makes this Prospectus as a whole or any of such information or the expression of any such opinions or intentions, misleading in any material respect. The Selling Shareholder accepts responsibility for and confirms only the statements specifically made by the Selling Shareholder in this Prospectus to the extent of information specifically pertaining to it and the Offered Shares assumes responsibility that such statements are true and correct in all material respects and not misleading in any material respect.			
<b>LISTING</b>			
The Equity Shares offered through the Red Herring Prospectus and this Prospectus are proposed to be listed on BSE and NSE. Our Company has received in-principle approvals from BSE and NSE for listing of the Equity Shares pursuant to their letters dated April 19, 2021 and May 4, 2021, respectively. For the purposes of this Offer, NSE shall be the Designated Stock Exchange. A signed copy of the Red Herring Prospectus was filed, and a signed copy of this Prospectus shall be filed with the RoC in accordance with Section 26(4) of the Companies Act, 2013. For details of the material contracts and documents made available for inspection from the date of the Red Herring Prospectus up to the Bid/Offer Closing Date, see "Material Contracts and Documents for Inspection" on page 336.			
<b>BOOK RUNNING LEAD MANAGERS</b>		<b>REGISTRAR TO THE OFFER</b>	
 <b>Equirus</b> Onward Upward			
<b>Equirus Capital Private Limited</b> 12 <sup>th</sup> Floor, C Wing, Marathon Futorex, N M Joshi Marg, Lower Parel, Mumbai 400 013 <b>Tel.:</b> +91 22 4332 0700 <b>E-mail:</b> rolexrings.ipo@equirus.com <b>Investor Grievance e-mail:</b> investorgrievance@equirus.com <b>Website:</b> www.equirus.com <b>Contact person:</b> Ankesh Jain <b>SEBI Registration Number:</b> INM000011286	<b>IDBI Capital Markets &amp; Securities Limited</b> 6 <sup>th</sup> Floor, IDBI Tower, WTC Complex, Cuffe Parade, Mumbai 400 005 <b>Tel.:</b> +91 22 2217 1700 <b>E-mail:</b> rolex.ipo@idbicapital.com <b>Investor grievance e-mail:</b> redressal@idbicapital.com <b>Website:</b> www.idbicapital.com <b>Contact Person:</b> Indrajit Bhagat/ Vaibhav Shah <b>SEBI Registration:</b> INM000010866	<b>JM Financial Limited</b> 7 <sup>th</sup> Floor, Energy, Appasaheb Marathe Marg, Prabhadevi, Mumbai 400 025 <b>Tel.:</b> +91 22 6630 3030 <b>E-mail:</b> rolexrings@jmf.com <b>Investor grievance e-mail:</b> grievance.idb@jmf.com <b>Website:</b> www.jmf.com <b>Contact Person:</b> Prachee Dhuri <b>SEBI Registration:</b> INM000010361	<b>Link Intime India Private Limited</b> C 101, 247 Park, L. B. S. Marg Vikhroli (West) Mumbai 400 083 <b>Tel.:</b> +91 22 4918 6200 <b>E-mail:</b> rolex.ipo@linkintime.co.in <b>Investor grievance e-mail:</b> rolex.ipo@linkintime.co.in <b>Website:</b> www.linkintime.co.in <b>Contact person:</b> Shanti Gopalkrishnan <b>SEBI Registration No.:</b> INR000004058
<b>BID/OFFER PROGRAMME</b>			
<b>BID/ OFFER OPENED ON:*</b>		<b>Wednesday, July 28, 2021</b>	
<b>BID/ OFFER CLOSED ON:</b>		<b>Friday, July 30, 2021</b>	

\* The Anchor Investor Bidding Date was one Working Day prior to the Bid/Offer Opening Date i.e. July 27, 2021.

*[This page has been intentionally left blank]*

## TABLE OF CONTENTS

<b>SECTION I – GENERAL</b> .....	<b>1</b>
DEFINITIONS AND ABBREVIATIONS.....	1
CERTAIN CONVENTIONS, USE OF FINANCIAL INFORMATION AND MARKET DATA AND CURRENCY OF PRESENTATION.....	11
FORWARD-LOOKING STATEMENTS.....	14
SUMMARY OF THE OFFER DOCUMENT.....	15
<b>SECTION II - RISK FACTORS</b> .....	<b>22</b>
<b>SECTION III – INTRODUCTION</b> .....	<b>49</b>
SUMMARY FINANCIAL INFORMATION.....	49
THE OFFER.....	54
GENERAL INFORMATION.....	56
CAPITAL STRUCTURE.....	64
OBJECTS OF THE OFFER.....	80
BASIS FOR OFFER PRICE.....	87
STATEMENT OF TAX BENEFITS.....	90
<b>SECTION IV – ABOUT OUR COMPANY</b> .....	<b>95</b>
INDUSTRY OVERVIEW.....	95
OUR BUSINESS.....	111
KEY REGULATIONS AND POLICIES.....	126
HISTORY AND CERTAIN CORPORATE MATTERS.....	131
OUR MANAGEMENT.....	136
OUR PROMOTER AND PROMOTER GROUP.....	152
OUR GROUP COMPANIES.....	157
RELATED PARTY TRANSACTIONS.....	159
DIVIDEND POLICY.....	160
<b>SECTION V – FINANCIAL INFORMATION</b> .....	<b>161</b>
FINANCIAL STATEMENTS.....	161
OTHER FINANCIAL INFORMATION.....	222
MANAGEMENT’S DISCUSSION AND ANALYSIS OF FINANCIAL CONDITION AND RESULTS OF OPERATIONS.....	224
CAPITALISATION STATEMENT.....	254
<b>SECTION VI – LEGAL AND OTHER INFORMATION</b> .....	<b>255</b>
OUTSTANDING LITIGATION AND MATERIAL DEVELOPMENTS.....	255
GOVERNMENT AND OTHER APPROVALS.....	258
OTHER REGULATORY AND STATUTORY DISCLOSURES.....	260
<b>SECTION VII – OFFER INFORMATION</b> .....	<b>272</b>
TERMS OF THE OFFER.....	272
OFFER STRUCTURE.....	277
OFFER PROCEDURE.....	280
RESTRICTIONS ON FOREIGN OWNERSHIP OF INDIAN SECURITIES.....	298
<b>SECTION VIII - MAIN PROVISIONS OF THE ARTICLES OF ASSOCIATION</b> .....	<b>299</b>
<b>SECTION IX – OTHER INFORMATION</b> .....	<b>336</b>
MATERIAL CONTRACTS AND DOCUMENTS FOR INSPECTION.....	336
DECLARATION.....	339

## SECTION I – GENERAL

### DEFINITIONS AND ABBREVIATIONS

*This Prospectus uses certain definitions and abbreviations which, unless the context otherwise indicates or implies, shall have the meaning as provided below. References to any legislation, act, regulation, rule, guideline, policy, circular, notification or clarification shall be to such legislation, act, regulation, rule, guideline, policy, circular, notification or clarification as amended.*

#### General Terms

Term	Description
“the Company”, “our Company”, or “the Issuer” or “we”, “our” or “us”	Rolex Rings Limited, a public limited company incorporated under the Companies Act, 1956, and having its Registered Office at B/h. Glowtech Steel Private Limited, Gondal Road, Kotharia, Rajkot, Gujarat 360 004.

#### Company Related Terms

Term	Description
“Articles” or “Articles of Association” or “AoA”	The articles of association of our Company, as amended from time to time.
Audit Committee	The audit committee of our Board, as described in “ <i>Our Management</i> ” on page 136.
“Auditors” or “Statutory Auditors”	The current statutory auditors of our Company, namely, S R B C & Co LLP, Chartered Accountants.
“Board” or “Board of Directors”	The board of directors of our Company (including any duly constituted committee thereof).
Consortium Lenders	Bank of Baroda, Punjab National Bank ( <i>erstwhile Oriental Bank of Commerce</i> ), Union Bank of India ( <i>erstwhile Corporation Bank</i> ), Indian Overseas Bank and Bank of India.
Corporate Office	Near Kotharia Railway Crossing, opposite Hotel Krishna Park, Gondal Road, Kotharia, Rajkot - 360004, Gujarat.
CSR Committee	The corporate social responsibility committee of our Board, as described in “ <i>Our Management</i> ” on page 136.
Director(s)	The director(s) on our Board.
Equity Shares	The equity shares of our Company of face value of ₹ 10 each.
Group Company	The company as described in “ <i>Our Group Companies</i> ” on page 157.
Independent Director(s)	Independent Director(s) on our Board.
IPO Committee	The committee constituted by our Board for the Offer.
Key Management/ Managerial Personnel	Key management/ managerial personnel of our Company in terms of the SEBI ICDR Regulations and the Companies Act, 2013 and as disclosed in “ <i>Our Management</i> ” on page 136.
“Memorandum” or “Memorandum of Association” or “MoA”	The memorandum of association of our Company, as amended from time to time.
Net Working Capital Requirements	Total current assets less total current liabilities excluding short-term borrowings and Current maturities of long-term debt.
NCRPS	The non-convertible redeemable preference shares of our Company of face value ₹ 10 each.
Nomination and Remuneration Committee	The nomination and remuneration committee of our Board, as described in “ <i>Our Management</i> ” on page 136.
OCRPS	The optionally convertible redeemable preference shares of our Company of face value ₹ 10 each
Preference Shares	NCRPS.
Promoter(s)	The promoters of our Company, namely, Rupesh Dayashankar Madeka, Jiten Dayashankar Madeka, Manesh Dayashankar Madeka, Pinakin Dayashankar Madeka and Bhautik Dayashankar Madeka.
Promoter Group	The entities constituting the promoter group of our Company in terms of Regulation 2(1) (pp) of the SEBI ICDR Regulations. For details, see “ <i>Our Promoter and Promoter Group</i> ” on page 152.
Registered Office	B/h. Glowtech Steel Private Limited, Gondal Road, Kotharia, Rajkot, Gujarat 360 004.
“Registrar of Companies” or “RoC”	The Registrar of Companies, Gujarat, Dadra and Nagar Haveli, located at Ahmedabad.
Restated Financial Statements	Restated financial statements of our Company as at and for the years ended March 31,

Term	Description
	2021, March 31, 2020 and March 31, 2019 (proforma) comprise the restated summary statement of assets and liabilities as at March 31, 2021, March 31, 2020 and March 31, 2019 (proforma), the restated summary statements of profit and loss and the restated summary statement of cash flows for the years ended March 31, 2021, March 31, 2020 and March 31, 2019 (proforma), together with the summary statement of significant accounting policies, and other explanatory information thereon derived from audited financial statements as at for the years ended March 31, 2021 prepared in accordance with Ind AS and audited financial statements as at for the years ended March 31, 2020 and March 31, 2019 prepared in accordance with Indian GAAP and restated in accordance with the SEBI ICDR Regulations, as amended and SEBI circular no. SEBI/HO/CFD/DIL/CIR/P/2016/47 dated March 31, 2016, as amended, and the Guidance Note on Reports in Company Prospectuses (Revised 2019) issued by the ICAI.
Shareholders	The holders of the Equity Shares from time to time.
Stakeholders' Relationship Committee	The stakeholders' relationship committee of our Board as described in "Our Management" on page 136.
Unit I	The manufacturing unit of our Company located at B/h. Glowtech Steels, Gondal Road, Kotharia, Rajkot, Gujarat 360 004.
Unit II	The manufacturing unit of our Company located near Kotharia Railway Crossing, opposite Hotel Krishna Park, Gondal Road, Kotharia, Rajkot, Gujarat 360 004.
Unit III	The manufacturing unit of our Company located near Kotharia Railway Crossing, opposite Hotel Krishna Park, Gondal Road, Kotharia, Rajkot, Gujarat 360 004.
Waiver Letters	The consent letters received from the Consortium Lenders.

### Offer Related Terms

Term	Description
Acknowledgement Slip	The slip or document issued by the relevant Designated Intermediary (ies) to the Bidder as proof of registration of the Bid cum Application Form.
'Allot' or 'Allotment' or 'Allotted'	Allotment of Equity Shares pursuant to the Fresh Issue and transfer of the Offered Shares by the Selling Shareholder (i.e. Rivendell PE LLC) pursuant to the Offer for Sale to the successful Bidders.
Allotment Advice	Advice or intimation of Allotment sent to the Bidders who have bid in the Offer after the Basis of Allotment has been approved by the Designated Stock Exchange.
Allottee	A successful Bidder to whom an Allotment is made.
Anchor Investor(s)	A Qualified Institutional Buyer, who had applied under the Anchor Investor Portion in accordance with SEBI ICDR Regulations and the Red Herring Prospectus, and who has Bid for an amount of at least ₹ 100 million.
Anchor Investor Allocation Price	₹ 900 per Equity Share i.e. the price at which Equity Shares were allocated to Anchor Investors according to the terms of the Red Herring Prospectus and this Prospectus, which was decided by our Company and the Selling Shareholder (i.e. Rivendell PE LLC) in consultation with the BRLMs.
Anchor Investor Application Form	The form used by an Anchor Investor to make a Bid in the Anchor Investor Portion and which will be considered as an application for Allotment in terms of the Red Herring Prospectus and this Prospectus.
Anchor Investor Bid/ Offer Period or Anchor Investor Bidding Date	July 27, 2021, being one Working Day prior to the Bid/ Offer Opening Date, on which Bids by Anchor Investors were submitted and allocation to Anchor Investors was completed.
Anchor Investor Offer Price	₹ 900 per Equity Share, being the final price at which the Equity Shares shall be Allotted to Anchor Investors in terms of the Red Herring Prospectus and this Prospectus.  The Anchor Investor Offer Price was decided by our Company and the Selling Shareholder (i.e. Rivendell PE LLC) in consultation with the BRLMs.
Anchor Investor Portion	60% of the QIB Portion which were made available for allocation by our Company and the Selling Shareholder (i.e. Rivendell PE LLC) in consultation with the BRLMs, to Anchor Investors on a discretionary basis in accordance with the SEBI ICDR Regulations.  One-third of the Anchor Investor Portion was reserved for domestic Mutual Funds, subject to valid Bids being received from domestic Mutual Funds at or above the Anchor Investor Allocation Price.

<b>Term</b>	<b>Description</b>
Anchor Investor Pay-in Date	With respect to Anchor Investor(s), the Anchor Investor Bidding Date, and in the event the Anchor Investor Allocation Price is lower than the Offer Price, not later than two Working Days after the Bid/ Offer Closing Date.
‘ASBA’ or ‘Application Supported by Blocked Amount’	An application, whether physical or electronic, used by Bidders/Applicants, other than Anchor Investors, to make a Bid and authorising an SCSB to block the Bid Amount in the specified bank account maintained with such SCSB and will include amounts blocked by RIIs using the UPI mechanism
ASBA Account	Account maintained with an SCSB which has been blocked by such SCSB or the account of the RII Bidder blocked upon acceptance of UPI Mandate Request by RIIs using the UPI mechanism to the extent of the Bid Amount of the Bidder/Applicant
ASBA Bid	A Bid made by an ASBA Bidder.
ASBA Bidder(s)	Any Bidder (other than an Anchor Investor) in the Offer who intends to submit a Bid.
ASBA Form	An application form, whether physical or electronic, used by ASBA Bidders which was considered as the application for Allotment in terms of the Red Herring Prospectus and this Prospectus.
Basis of Allotment	Basis on which Equity Shares will be Allotted to successful Bidders under the Offer, described in “ <i>Offer Procedure</i> ” on page 280.
Bid(s)	An indication by a Bidder (other than an Anchor Investor) to make an offer during the Bid/Offer Period pursuant to submission of the ASBA Form, or on the Anchor Investor Bidding Date by an Anchor Investor, pursuant to the submission of the Anchor Investor Application Form, to subscribe to or purchase Equity Shares at a price within the Price Band, including all revisions and modifications thereto, to the extent permissible under the SEBI ICDR Regulations, in terms of the Red Herring Prospectus and the Bid cum Application Form.  The term ‘Bidding’ shall be construed accordingly.
Bid Amount	The highest value of optional Bids indicated in the Bid cum Application Form, and payable by an Anchor Investor or blocked in the ASBA Account of an ASBA Bidder, as the case may be, upon submission of the Bid in the Offer.
Bid cum Application Form ‘Bidder’ or ‘Applicant’	The Anchor Investor Application Form or the ASBA Form, as the context requires. Any prospective investor who makes a Bid pursuant to the terms of the Red Herring Prospectus and the Bid cum Application Form and unless otherwise stated or implied, includes an Anchor Investor.
Bidding Centres	Centres at which the Designated Intermediaries shall accept the ASBA Forms, <i>i.e.</i> , Designated SCSB Branches for SCSBs, Specified Locations for Members of the Syndicate, Broker Centres for Registered Brokers, Designated RTA Locations for RTAs and Designated CDP Locations for CDPs.
Bid Lot	16 Equity Shares and in the multiple of 16 Equity Shares thereafter.
Bid/ Offer Closing Date	Except in relation to any Bids received from the Anchor Investors, the date after which the Designated Intermediaries did not accept any Bids being July 30, 2021, which was notified in all editions of the English national daily newspaper Financial Express, all editions of the Hindi national daily newspaper Jansatta, and the Rajkot edition of Gujarati daily newspaper Jaihind (Gujarati being the regional language of Gujarat wherein our Registered Office is located), each with wide circulation.
Bid/ Offer Opening Date	Except in relation to any Bids received from the Anchor Investors, the date on which the Designated Intermediaries started accepting Bids being July 28, 2021, which was notified in all editions of the English national daily newspaper Financial Express, all editions of the Hindi national daily newspaper Jansatta, and the Rajkot edition of Gujarati daily newspaper Jaihind (Gujarati being the regional language of Gujarat wherein our Registered Office is located), each with wide circulation, and in case of any revision, the extended Bid/ Offer Opening Date also to be notified on the website and terminals of the Members of the Syndicate and communicated to the Designated Intermediaries and the Sponsor Bank, as required under the SEBI ICDR Regulations.
Bid/ Offer Period	Except in relation to Anchor Investors, the period between the Bid/ Offer Opening Date and the Bid/ Offer Closing Date, inclusive of both days, during which Bidders have submitted their Bids, including any revisions thereof.
Book Building Process	Book building process, as provided in Schedule XIII of the SEBI ICDR Regulations, in terms of which the Offer is being made.
‘Book Running Lead Managers’ or ‘BRLMs’	The book running lead managers to the Offer, being Equirus Capital Private Limited IDBI Capital Markets & Securities Limited and JM Financial Limited.
Broker Centres	Broker centres notified by the Stock Exchanges where ASBA Bidders could submit

<b>Term</b>	<b>Description</b>
	the ASBA Forms to a Registered Broker.  The details of such Broker Centres, along with the names and contact details of the Registered Brokers are available on the respective websites of the Stock Exchanges at <a href="http://www.bseindia.com">www.bseindia.com</a> and <a href="http://www.nseindia.com">www.nseindia.com</a> .
'CAN' or 'Confirmation of Allocation Note'	Notice or intimation of allocation of the Equity Shares sent to Anchor Investors, who have been allocated the Equity Shares, after the Anchor Investor Bidding Date.
Cap Price	The higher end of the Price Band, being ₹ 900 per Equity Share..
Client ID	Client identification number maintained with one of the Depositories in relation to the demat account.
'CDP' or 'Collecting Depository Participant'	A depository participant as defined under the Depositories Act, 1996, registered with SEBI and who is eligible to procure Bids at the Designated CDP Locations in terms of circular no. CIR/CFD/POLICYCELL/11/2015 dated November 10, 2015 issued by SEBI.
Compliance Officer for the Offer	Compliance officer for the Offer in terms of the SEBI ICDR Regulations.
Cut-Off Price	Offer Price, which shall be any price within the Price Band, finalised by our Company and the Selling Shareholder (i.e. Rivendell PE LLC) in consultation with the BRLMs.  Only Retail Individual Bidders were entitled to Bid at the Cut-off Price. QIBs (including Anchor Investor) and Non-Institutional Bidders were not entitled to Bid at the Cut-off Price.
Designated CDP Locations	Such locations of the CDPs where Bidders could submit the ASBA Forms.  The details of such Designated CDP Locations, along with names and contact details of the Collecting Depository Participants eligible to accept ASBA Forms are available on the respective websites of the Stock Exchanges ( <a href="http://www.bseindia.com">www.bseindia.com</a> and <a href="http://www.nseindia.com">www.nseindia.com</a> , respectively,) as updated from time to time.
Designated Date	The date on which the Escrow Collection Bank(s) transfers funds from the Escrow Account, and funds blocked by the SCSBs and Sponsor Bank are transferred from the ASBA Accounts, as the case may be, to the Public Offer Account or the Refund Account, as appropriate, after finalisation of the Basis of Allotment, in terms of the Red Herring Prospectus and this Prospectus, following which the Equity Shares will be Allotted in the Offer.
Designated Intermediary(ies)	Collectively, the Syndicate, Sub-Syndicate Members/ agents, SCSBs, Registered Brokers, CDPs and RTAs, who are authorised to collect Bid cum Application Forms from the Bidders in the Offer.
Designated RTA Locations	Such locations of the RTAs where Bidders could submit the ASBA Forms to RTAs. The details of such Designated RTA Locations, along with names and contact details of the RTAs eligible to accept ASBA Forms are available on the respective websites of the Stock Exchanges ( <a href="http://www.bseindia.com">www.bseindia.com</a> and <a href="http://www.nseindia.com">www.nseindia.com</a> , respectively,) as updated from time to time.
Designated SCSB Branches	Such branches of the SCSBs which collected the ASBA Forms used by the Bidders, a list of which is available on the website of SEBI at <a href="http://www.sebi.gov.in/sebiweb/other/OtherAction.do?doRecognisedFpi=yes&amp;intmId=35">http://www.sebi.gov.in/sebiweb/other/OtherAction.do?doRecognisedFpi=yes&amp;intmId=35</a> , updated from time to time, or at such other website as may be prescribed by SEBI from time to time.
Designated Stock Exchange	National Stock Exchange of India Limited (NSE)
Draft Red Herring Prospectus or DRHP	The draft red herring prospectus dated March 17, 2021 issued in accordance with the SEBI ICDR Regulations, which does not contain complete particulars of the price at which the Equity Shares will be Allotted and the size of the Offer.
Eligible NRI	NRI(s) from jurisdictions outside India where it was not unlawful to make an offer or invitation under the Offer and in relation to whom the Bid cum Application Form and the Red Herring Prospectus constituted an invitation to purchase the Equity Shares.
Equirus	Equirus Capital Private Limited
Escrow Account(s)	Account(s) opened with the Escrow Collection Bank and in whose favour Anchor Investors have transferred the money through direct credit/NEFT/RTGS/NACH in respect of the Bid Amount while submitting a Bid.
Escrow Agreement	The agreement dated July 20, 2021 amongst our Company, the Selling Shareholder (i.e. Rivendell PE LLC), the Registrar to the Offer, the BRLMs, the Escrow Collection Bank(s), the Public Offer Account Bank(s), the Sponsor Bank, and the Refund Bank(s) for among other things, collection of the Bid Amounts from the Anchor Investors and where applicable, refunds of the amounts collected from Anchor Investors, on the terms and conditions thereof.

<b>Term</b>	<b>Description</b>
Escrow Collection Bank	Bank(s) which is a clearing member and registered with SEBI as a banker to an issue, and with whom the Escrow Account(s) were opened, in this case being ICICI Bank Limited.
First or sole Bidder	The Bidder whose name has been mentioned in the Bid cum Application Form or the Revision Form and in case of joint Bids, whose name also appears as the first holder of the beneficiary account held in joint names.
Floor Price	The lower end of the Price Band, being ₹ 880 per Equity Share.
Fresh Issue	The issue of 622,222 Equity Shares aggregating to ₹ 560 million by our Company.
General Information Document or GID	The General Information Document for investing in public offers, prepared and issued in accordance with the circular (SEBI/HO/CFD/DIL1/CIR/P/2020/37) dated March 17, 2020 issued by SEBI, suitably modified and updated pursuant to, among others, the circular (SEBI/HO/CFD/DIL2/CIR/P/2020/50) dated March 30, 2020 issued by SEBI.
ICRA	ICRA Limited.
ICRA Report	Report titled “ <i>Indian Bearings Industry – Industry revenue to witness a smart recovery in FY 2022</i> ” dated March, 2021 prepared by ICRA Limited.
IDBI	IDBI Capital Markets & Securities Limited.
JM	JM Financial Limited.
Maximum RIB Allottees	Maximum number of RIBs who can be allotted the minimum Bid Lot. This is computed by dividing the total number of Equity Shares available for Allotment to RIBs by the minimum Bid Lot.
Materiality Policy	Policy for identification of group companies, material outstanding civil litigations proceedings of our Company, our Promoters and our Directors and material creditors of the Company, pursuant to the disclosure requirements under SEBI ICDR Regulations, as adopted by the Board through its resolution dated March 12, 2021.
Mutual Fund Portion	81,223 Equity Shares which were available for allocation to Mutual Funds only on a proportionate basis, subject to valid Bids being received at or above the Offer Price.
Mutual Funds	Mutual funds registered with SEBI under the Securities and Exchange Board of India (Mutual Funds) Regulations, 1996.
Net Proceeds	Proceeds of the Fresh Issue less our Company’s share of the Offer expenses.
Net QIB Portion	The portion of the QIB Portion less the number of Equity Shares Allotted to the Anchor Investors.
NBFC-SI	A systemically important non-banking financial company as defined under Regulation 2(1)(iii) of the SEBI ICDR Regulations.
Non-Institutional Bidders	Bidders that are not QIBs or Retail Individual Bidders and who have Bid for Equity Shares for an amount more than ₹ 200,000.
Non-Institutional Portion	Not less than 1,218,334 Equity Shares which were available for allocation to Non-Institutional Bidders on a proportionate basis, subject to valid Bids being received at or above the Offer Price.
‘Non-Resident’ or ‘NR’	A person resident outside India, as defined under FEMA and includes FPIs, VCFs, FVCIs and NRIs.
Offer	Initial public offering of 8,122,222 Equity Shares for cash at a price of ₹ 900 per Equity Share (including a premium of ₹ 890 per Equity Share) aggregating to ₹ 7,310 million (the “ <b>Offer</b> ”). The Offer comprises of a Fresh Issue of 622,222 Equity Shares aggregating to ₹ 560 million and an Offer for Sale of 7,500,000 Equity Shares aggregating up to ₹ 6,750 million.
Offer Agreement	The agreement dated March 17, 2021 among our Company, the Selling Shareholder (i.e. Rivendell PE LLC), the BRLMs, pursuant to which certain arrangements are agreed to in relation to the Offer and amendment dated July 20, 2021.
Offer for Sale	The offer for sale of 7,500,000 Equity Shares aggregating up to ₹ 6,750 million by the Selling Shareholder (i.e. Rivendell PE LLC).
Offer Price	The final price at which Equity Shares will be Allotted to successful ASBA Bidders in terms of this Prospectus.  The Offer Price was decided by our Company and the Selling Shareholder (i.e. Rivendell PE LLC) in consultation with the BRLMs on the Pricing Date, in accordance with the Book-Building Process and in terms of the Red Herring Prospectus.
Offered Shares	Equity Shares being offered for sale by the Selling Shareholder (i.e. Rivendell PE LLC) in the Offer.
Offer Proceeds	The gross proceeds of this Offer based on the total number of Equity Shares Allotted under this Offer and the Offer Price.
Price Band	The price band ranging from the Floor Price of ₹ 880 per Equity Share to the Cap Price



<b>Term</b>	<b>Description</b>
	of ₹ 900 per Equity Share, including any revisions thereof. The Price Band and minimum Bid Lot, as decided by our Company and the Selling Shareholder (i.e. Rivendell PE LLC), in consultation with the BRLMs will be advertised in all editions of the English national daily newspaper Financial Express, all editions of the Hindi national daily newspaper Jansatta, and Rajkot edition of the Gujarati daily newspaper Jaihind (Gujarati being the regional language of Gujarat wherein our Registered Office is located), each with wide circulation, at least two Working Days prior to the Bid/ Offer Opening Date with the relevant financial ratios calculated at the Floor Price and at the Cap Price, and shall be made available to the Stock Exchanges for the purpose of uploading on their respective websites.
Pricing Date	The date on which our Company and Selling Shareholder (i.e. Rivendell PE LLC) in consultation with the BRLMs, have finalised the Offer Price.
Prospectus	This prospectus dated August 3, 2021, to be filed with the RoC after the Pricing Date in accordance with Section 26 of the Companies Act, 2013, and the SEBI ICDR Regulations containing, <i>inter alia</i> , the Offer Price, the size of the Offer and certain other information, including any addenda or corrigenda thereto.
Public Offer Account	The bank account opened with the Public Offer Account Bank under Section 40(3) of the Companies Act, 2013, to receive monies from the Escrow Account and from the ASBA Accounts on the Designated Date.
Public Offer Account Bank	Bank which is a clearing member and registered with SEBI as a banker to an issue, and with whom the Public Offer Account(s) were opened, in this case being ICICI Bank Limited..
‘QIBs’ or ‘Qualified Institutional Buyers’	Qualified institutional buyers as defined under Regulation 2(1)(ss) of the SEBI ICDR Regulations.
QIB Bidders	QIBs who Bid in the Offer.
QIB Portion	4,061,110 Equity Shares, which shall be available for allocation to QIBs (including Anchor Investors) on a proportionate basis, subject to valid Bids being received at or above the Offer Price.
QIB Bid/ Offer Closing Date	Same as the Bid/Offer Closing Date.
‘Red Herring Prospectus’ or ‘RHP’	The red herring prospectus dated July 21, 2021 issued in accordance with Section 32 of the Companies Act, 2013 read with corrigendum dated July 24, 2021, and the provisions of the SEBI ICDR Regulations, which will not have complete particulars of the price at which the Equity Shares have been offered and the size of the Offer, including any addenda or corrigenda thereto. The Red Herring Prospectus was filed with the RoC at least three days before the Bid/Issue Opening Date.
Refund Account	The account opened with the Refund Bank(s), from which refunds, if any, of the whole or part of the Bid Amount to Anchor Investors shall be made.
Refund Bank	The Banker to the Offer with whom the Refund Account(s) were opened, in this case being ICICI Bank Limited.
Registrar Agreement	The agreement dated March 17, 2021, entered into between our Company, the Selling Shareholder (i.e. Rivendell PE LLC) and the Registrar to the Offer, in relation to the responsibilities and obligations of the Registrar to the Offer pertaining to the Offer.
Registered Brokers	Stock brokers registered with SEBI under the Securities and Exchange Board of India (Stock Brokers and Sub-Brokers) Regulations, 1992 and the stock exchanges having nationwide terminals, other than the Members of the Syndicate and eligible to procure Bids in terms of Circular No. CIR/CFD/14/2012 dated October 4, 2012, issued by SEBI.
‘Registrar to the Offer’ or ‘Registrar’	Link Intime India Private Limited.
‘RTAs’ or ‘Registrar and Share Transfer Agents’	The registrar and share transfer agents registered with SEBI and eligible to procure Bids at the Designated RTA Locations in terms of circular no. CIR/CFD/POLICYCELL/11/2015 dated November 10, 2015, issued by SEBI.
Resident Indian	A person resident in India, as defined under FEMA.
‘Retail Individual Bidder(s)’ or ‘Retail Individual Investor(s)’ or ‘RII(s)’ or ‘RIB(s)’	Individual Bidders, who have Bid for the Equity Shares for an amount which is not more than ₹ 200,000 in any of the bidding options in the Offer (including HUFs applying through their Karta and Eligible NRI Bidders) and does not include NRIs (other than Eligible NRIs).
Retail Portion	The portion of the Net Issue being not less than 35% of the Net Issue consisting of 2,842,778 Equity Shares, available for allocation to Retail Individual Bidders as per the SEBI ICDR Regulations, subject to valid Bids being received at or above the Offer Price, which shall not be less than the minimum Bid Lot subject to availability in the Retail Portion, and the remaining Equity Shares to be Allotted on a proportionate basis.
Revision Form	Form used by the Bidders to modify the quantity of the Equity Shares or the Bid

<b>Term</b>	<b>Description</b>
	Amount in any of their Bid cum Application Forms or any previous Revision Form(s).  QIB Bidders and Non-Institutional Bidders were not allowed to withdraw or lower their Bids (in terms of quantity of Equity Shares or the Bid Amount) at any stage. Retail Individual Bidders could revise their Bids during the Bid/ Offer Period and withdraw their Bids until the Bid/ Offer Closing Date.
‘Self Certified Syndicate Bank(s)’ or ‘SCSB(s)’	The banks registered with SEBI, offering services in relation to ASBA, a list of which is available on the website of SEBI at <a href="http://www.sebi.gov.in/sebiweb/other/OtherAction.do?doRecognisedFpi=yes&amp;intmId=35">http://www.sebi.gov.in/sebiweb/other/OtherAction.do?doRecognisedFpi=yes&amp;intmId=35</a> or such other websites and updated from time to time.
Selling Shareholder	Rivendell PE LLC ( <i>formerly known as NSR-PE Mauritius LLC</i> ).
Share Escrow Agent	The share escrow agent appointed pursuant to the Share Escrow Agreement, namely Link Intime India Private Limited
Share Escrow Agreement	The agreement dated July 20, 2021 between our Company, the Selling Shareholder (i.e. Rivendell PE LLC) and the Share Escrow Agent in connection with the transfer of the Offered Shares by the Selling Shareholder (i.e. Rivendell PE LLC) and credit of such Equity Shares to the demat account of the Allottees in accordance with the Basis of Allotment.
Specified Locations	Bidding centres where the Syndicate accepted ASBA Forms from Bidders.
Sponsor Bank	Bank registered with SEBI which is appointed by the issuer to act as a conduit between the Stock Exchanges and the National Payments Corporation of India in order to push the mandate collect requests and / or payment instructions of the RIIs into the UPI, the Sponsor Bank in this case being ICICI Bank Limited.
Sub-Syndicate Members	The sub-syndicate members, if any, appointed by the BRLMs and the Syndicate Members, to collect ASBA Forms and Revision Forms.
Syndicate Agreement	The agreement dated July 20, 2021 between our Company, the Registrar to the Offer, the Selling Shareholder (i.e. Rivendell PE LLC), the BRLMs and the Syndicate Members in relation to the procurement of Bid cum Application Forms by the Syndicate.
Syndicate Members	Intermediaries (other than the BRLMs) registered with SEBI who are permitted to accept bids, applications and place order with respect to the Offer and carry out activities as an underwriter, namely Equirus Securities Private Limited and JM Financial Services Limited.
‘Syndicate’ or ‘Members of the Syndicate’	the BRLMs and the Syndicate Members.
Underwriters	The BRLMs and the Syndicate Members.
Underwriting Agreement	The agreement dated August 3, 2021 between the Underwriters, our Company and the Selling Shareholder (i.e. Rivendell PE LLC).
UPI Circulars	The SEBI circular no. SEBI/HO/CFD/DIL2/CIR/P/2018/138 dated November 1, 2018, SEBI circular no. SEBI/HO/CFD/DIL2/CIR/P/2019/50 dated April 3, 2019, SEBI circular no. SEBI/HO/CFD/DIL2/CIR/P/2019/76 dated June 28, 2019, SEBI circular no. SEBI/HO/CFD/DIL2/CIR/P/2019/85 dated July 26, 2019, SEBI/HO/CFD/DCR2/CIR/P/2019/133 dated November 8, 2019, SEBI/HO/CFD/DIL2/CIR/P/2020/50 dated March 30, 2020, SEBI circular no. SEBI/HO/CFD/DIL2/CIR/2021/2480/1/M dated March 16, 2021, SEBI circular no. SEBI/HO/CFD/DIL2/P/CIR/2021/570 dated June 2, 2021 and any subsequent circulars or notifications issued by SEBI in this regard
UPI ID	ID created on Unified Payment Interface (UPI) for single-window mobile payment system developed by the National Payments Corporation of India (NPCI).
UPI Mandate Request	A request (intimating the RII by way of a notification on the UPI application and by way of a SMS directing the RII to such UPI application) to the RII initiated by the Sponsor Bank to authorise blocking of funds on the UPI application equivalent to Bid Amount and subsequent debit of funds in case of Allotment
UPI mechanism	The bidding mechanism used by an RII to make a Bid in the Offer in accordance with UPI Circulars.
UPI PIN	Password to authenticate UPI transaction
Wilful Defaulter	Wilful defaulter as defined under Regulation 2(1)(III) of the SEBI ICDR Regulations
Working Day	All days other than second and fourth Saturday of the month, Sunday or a public holiday, on which commercial banks in Mumbai are open for business; provided, however, with reference to (a) announcement of Price Band; and (b) Bid/ Offer Period, the expression “Working Day” shall mean all days on which commercial banks in Mumbai are open for business, excluding all Saturdays, Sundays or public holidays; and (c) with reference to the time period between the Bid/ Offer Closing Date and the

Term	Description
	listing of the Equity Shares on the Stock Exchanges, the expression 'Working Day' shall mean all trading days of Stock Exchanges, excluding Sundays and bank holidays, in terms of the circulars issued by SEBI.

### Technical/ Industry Related Terms/ Abbreviations

Term	Description
2W	Two wheeler
3W	Three wheeler
ACE	ACE Micromatic Group
CAGR	Compounded Annual Growth Rate $((\text{End Value}/\text{Beginning Value})^{1/\text{number of years}} - 1)$
CDR	Corporate Debt Restructuring
CV	Commercial vehicles
DMG	DMG MORI
FDI	Foreign Direct Investment
FUGI	FUGI Corporation
GDP	Gross Domestic Product
GFCF	Gross Fixed Capital Formation
Hyundai	Hyundai WIA
IATF	International Automotive Task Force
ISO	International Organization For Standardization
JTEKT	JTEKT Corporation
Mazak	Mazak Corporation
Muratec	Murata Machinery Ltd
NSK	NSK Corporation
NTN	NTN Corporation
OE	Original equipment
OEM	Original equipment manufacturer
OPM	Operations performance management
PV	Passenger vehicle
TSUGAMI	TSUGAMI Corporation
UV	Utility vehicle

### Conventional and General Terms or Abbreviations

Term	Description
'Mn' or 'mn'	Million.
AGM	Annual General Meeting.
AIF	An alternative investment fund as defined in and registered with SEBI under the Securities and Exchange Board of India (Alternative Investment Funds) Regulations, 2012.
BSE	BSE Limited.
Category II FPI	FPIs registered as "Category II foreign portfolio investors" under the Securities and Exchange Board of India (Foreign Portfolio Investors) Regulations, 2014.
CDSL	Central Depository Services (India) Limited.
CIN	Corporate Identity Number.
CIT	Commissioner of Income Tax.
Companies Act	Companies Act, 1956 and Companies Act, 2013, as applicable.
Companies Act, 1956	The erstwhile Companies Act, 1956 along with the relevant rules made thereunder.
Companies Act, 2013	Companies Act, 2013, along with the relevant rules, regulations, clarifications, circulars and notifications issued thereunder, as amended to the extent currently in force.
Contract Labour Act	The Contract Labour (Regulation and Abolition) Act, 1970.
CSR	Corporate Social Responsibility.
Depositories	NSDL and CDSL.
Depositories Act	The Depositories Act, 1996, read with regulations framed thereunder.
DIN	Director Identification Number.
DP ID	Depository Participant's Identity Number.
DP or Depository Participant	A depository participant as defined under the Depositories Act.
EGM	Extraordinary General Meeting.

<b>Term</b>	<b>Description</b>
Employees Provident Fund Act	Employees Provident Funds and Miscellaneous Provisions Act, 1952.
EPS	Earnings Per Share.
FAQs	Frequently asked questions.
FCNR	Foreign currency non-resident account.
FDI	Foreign Direct Investment.
FDI Circular	The consolidated FDI Policy, issued by the Department of Promotion of Industry and Internal Trade, Ministry of Commerce and Industry, Government of India, and any modifications thereto or substitutions thereof, issued from time to time
FEMA	Foreign Exchange Management Act, 1999, read with rules and regulations thereunder.
FEMA NDI Rules	Foreign Exchange Management (Non-debt Instrument) Rules, 2019.
'Financial Year' or 'Fiscal' or 'Fiscal Year' or 'FY'	The period of 12 months commencing on April 1 of the immediately preceding calendar year and ending on March 31 of that particular calendar year.
FPI(s)	Foreign portfolio investors as defined under the SEBI FPI Regulations.
FVCI	Foreign venture capital investors as defined and registered under the SEBI FVCI Regulations.
GDP	Gross domestic product.
GoI or Government or Central Government	The Government of India.
GST	Goods and services tax.
HUF	Hindu undivided family.
ICAI	The Institute of Chartered Accountants of India.
IFRS	International Financial Reporting Standards of the International Accounting Standards Board.
Income Tax Act	Income- Tax Act, 1961, read with the rules framed thereunder.
Income Tax Rules	Income- Tax Rules, 1962.
Ind AS	Indian Accounting Standards prescribed under section 133 of the Companies Act, 2013, as notified under Companies (Indian Accounting Standard) Rules, 2015, as amended.
Indian GAAP	Accounting standards notified under section 133 of the Companies Act, 2013, read with Companies (Accounting Standards) Rules, 2006, as amended and the Companies (Accounts) Rules, 2014, as amended
IPO	Initial public offering.
IST	Indian Standard Time.
MCA	Ministry of Corporate Affairs, Government of India.
N.A.	Not applicable.
NAV	Net asset value.
NEFT	National Electronic Fund Transfer.
NRE Account	Non-Resident External account.
NRI	A person resident outside India, who is a citizen of India or an overseas citizen of India cardholder within the meaning of section 7(A) of the Citizenship Act, 1955.
NSDL	National Securities Depository Limited.
NSE	National Stock Exchange of India Limited.
'OCB' or 'Overseas Corporate Body'	A company, partnership, society or other corporate body owned directly or indirectly to the extent of at least 60% by NRIs including overseas trusts, in which not less than 60% of beneficial interest is irrevocably held by NRIs directly or indirectly and which was in existence on October 3, 2003 and immediately before such date was eligible to undertake transactions pursuant to general permission granted to OCBs under FEMA. OCBs are not allowed to invest in the Offer.
p.a.	Per annum.
P/E Ratio	Price/earnings ratio.
PAN	Permanent account number.
PAT	Profit after tax.
RBI	Reserve Bank of India.
RTGS	Real time gross settlement.
Regulation S	Regulation S under the U.S. Securities Act
SCRA	Securities Contracts (Regulation) Act, 1956.
SCRR	Securities Contracts (Regulation) Rules, 1957.
SEBI	Securities and Exchange Board of India constituted under the SEBI Act, 1992.
SEBI Act	Securities and Exchange Board of India Act, 1992.
SEBI AIF Regulations	Securities and Exchange Board of India (Alternative Investment Funds) Regulations, 2012.

<b>Term</b>	<b>Description</b>
SEBI FPI Regulations	Securities and Exchange Board of India (Foreign Portfolio Investors) Regulations, 2014.
SEBI FVCI Regulations	Securities and Exchange Board of India (Foreign Venture Capital Investors) Regulations, 2000.
SEBI ICDR Regulations	Securities and Exchange Board of India (Issue of Capital and Disclosure Requirements) Regulations, 2018.
SEBI Listing Regulations	Securities and Exchange Board of India (Listing Obligations and Disclosure Requirements) Regulations, 2015.
SEBI VCF Regulations	Securities and Exchange Board of India (Venture Capital Fund) Regulations, 1996.
State Government	The government of a state in India.
Stock Exchanges	Collectively, the BSE and NSE.
STT	Securities transaction tax.
Takeover Regulations	Securities and Exchange Board of India (Substantial Acquisition of Shares and Takeovers) Regulations, 2011.
TAN	Tax deduction account number.
TDS	Tax deducted at source.
U.S. GAAP	Generally accepted accounting principles of the United States of America.
U.S. Securities Act	U.S. Securities Act of 1933, as amended.
VAT	Value added tax.
VCFs	Venture capital funds as defined in and registered with SEBI under SEBI VCF Regulations.
Year/ Calendar Year	The 12 month period ending December 31.

Words and expressions used but not defined herein shall have the same meaning as is assigned to such terms in the SEBI ICDR Regulations, the Companies Act, the SEBI Act, the SCRA, the Depositories Act and the rules and regulations made thereunder.

Notwithstanding the foregoing, capitalised terms in “*Statement of Tax Benefits*”, “*Financial Statements*”, “*Basis for Offer Price*”, “*Outstanding Litigation and Material Developments*”, “*Offer Procedure*” and “*Main Provision of the Articles of Association*” on pages 90, 161, 87, 255, 280 and 299 respectively, shall have the meaning as ascribed to such terms in such sections.

## CERTAIN CONVENTIONS, USE OF FINANCIAL INFORMATION AND MARKET DATA AND CURRENCY OF PRESENTATION

### Page Numbers

Unless otherwise stated, all references to page numbers in this Prospectus are to page numbers of this Prospectus.

### Currency and Units of Presentation

All references to “*Rupee(s)*”, “*Rs.*” or “₹” or “*INR*” are to Indian Rupees, the official currency of the Republic of India. All references to “*US\$*” or “*U.S. Dollars*” or “*USD*” are to United States Dollars, the official currency of the United States of America. All references to “*EUR*” or “*€*” are to Euro, the official currency of the European Union.

### Exchange Rates

This Prospectus contains conversions of certain other currency amounts into Rupees that have been presented solely to comply with the requirements of SEBI ICDR Regulations. Unless otherwise stated, the exchange rates referred to for the purpose of conversion of foreign currency amounts into Rupee amounts, are as follows:

(in ₹)

Currency	Exchange rate as on		
	March 31, 2021	March 31, 2020	March 31, 2019
USD <sup>#</sup>	73.50	75.39	69.17
Euro <sup>#</sup>	86.10	83.05	77.70

<sup>#</sup>Source: <https://www.fbil.org.in/>. On instances where the given day is a holiday, the exchange rate from the previous working day has been considered.

Such conversion should not be considered as a representation that such currency amounts have been, could have been or can be converted into Rupees at any particular rate, the rates stated above or at all.

### Time

All references to time in this Prospectus are to Indian Standard Time.

### Financial and Other Data

Unless stated or the context requires otherwise, the financial information in this Prospectus is derived from our Restated Financial Statements. The restated summary statements of assets and liabilities as at March 31, 2021, March 31, 2020 and March 31, 2019 (proforma) and the restated summary statement of profit and loss (including other comprehensive income), cash flow statement and changes in equity for the years ended March 31, 2021, March 31, 2020 and March 31, 2019 (proforma) of the Company together with the summary statement of significant accounting policies, and other explanatory information thereon, derived from audited financial statements as at and for the years ended March 31, 2021 prepared in accordance with Ind AS and March 31, 2020 and March 31, 2019 prepared in accordance with Indian GAAP and restated in accordance with the SEBI ICDR Regulations, as amended, and the SEBI circular no. SEBI/HO/CFD/DIL/CIR/P/2016/47 dated March 31, 2016, and the Guidance Note on “Reports in Company Prospectuses (Revised 2019)” issued by ICAI.

There are significant differences between Indian GAAP, Ind AS, U.S. GAAP and IFRS. Our Company does not provide reconciliation of its financial information to IFRS or U.S. GAAP. Our Company has not attempted to explain those differences or quantify their impact on the financial data included in this Prospectus and it is urged that you consult your own advisors regarding such differences and their impact on our financial data. Accordingly, the degree to which the financial information included in this Prospectus will provide meaningful information is entirely dependent on the reader’s level of familiarity with Indian accounting policies and practices, the Companies Act, Ind AS, and the SEBI ICDR Regulations. Any reliance by persons not familiar with Indian accounting policies and practices on the financial disclosures presented in this Prospectus should, accordingly, be limited.

Our Company’s fiscal year commences on April 1 of each year and ends on March 31 of the next year. Accordingly, all references to a particular fiscal year (referred to herein as “**Fiscal**”, “**Fiscal Year**” or “**FY**”) are

to the 12 months period ended March 31 of that particular year, unless otherwise specified.

All the figures in this Prospectus, except for figures derived from the ICRA Report (which are in crores), have been presented in million or in whole numbers where the numbers have been too small to present in million unless stated otherwise. One million represents 1,000,000 and one billion represents 1,000,000,000. Certain figures contained in this Prospectus, including financial information, have been subject to rounding adjustments. Any discrepancies in any table between the totals and the sum of the amounts listed are due to rounding off. Except for figures derived from our Restated Financial Statements (which are rounded off to the 2<sup>nd</sup> decimal), all figures in decimals have been rounded off to the second decimal. In certain instances, (i) the sum or percentage change of such numbers may not conform exactly to the total figure given, and (ii) the sum of the figures in a column or row in certain tables may not conform exactly to the total figure given for that column or row. However, figures sourced from third-party industry sources may be expressed in denominations other than million or may be rounded off to other than two decimal points in the respective sources, and such figures have been expressed in this Prospectus in such denominations or rounded-off to such number of decimal points as provided in such respective sources.

Unless the context otherwise indicates, any percentage amounts, as set forth in “*Risk Factors*”, “*Our Business*” and “*Management’s Discussion and Analysis of Financial Condition and Results of Operations*” on pages 22, 111 and 224, respectively, and elsewhere in this Prospectus have been calculated on the basis of amounts derived from the Restated Financial Statements.

#### *Non- GAAP Financial Measures*

This Prospectus contains certain non-GAAP financial measures and certain other statistical information relating to our operations and financial performance like EBITDA, EBITDA margin, net worth, return on net worth, Net Asset Value per Equity Share, debt equity ratio, total borrowings to total equity, and certain other statistical information relating to our operations and financial performance that are not required by, or presented in accordance with, Ind AS, Indian GAAP, or IFRS. Further, these Non-GAAP Measures are not a measurement of our financial performance or liquidity under Ind AS, Indian GAAP, IFRS or US GAAP and should not be considered in isolation or construed as an alternative to cash flows, profit/ (loss) for the years or any other measure of financial performance or as an indicator of our operating performance, liquidity, profitability or cash flows generated by operating, investing or financing activities derived in accordance with Ind AS, Indian GAAP, IFRS or US GAAP. We compute and disclose such non-Indian GAAP financial measures and such other statistical information relating to our operations and financial performance as we consider such information to be useful measures of our business and financial performance. These non-Indian GAAP financial measures and other statistical and other information relating to our operations and financial performance may not be computed on the basis of any standard methodology that is applicable across the industry and therefore may not be comparable to financial measures and statistical information of similar nomenclature that may be computed and presented by other companies and are not measures of operating performance or liquidity defined by Ind AS and may not be comparable to similarly titled measures presented by other companies.

#### **Industry and Market Data**

The industry and market data set forth in this Prospectus have been obtained or derived from publicly available information as well as industry publications and sources. Industry publications generally state that the information contained in those publications has been obtained from sources believed to be reliable but their accuracy and completeness are not guaranteed and their reliability cannot be assured. Although we have no reason to believe that industry data used in this Prospectus is not reliable, such data has not been independently verified by us, none of our Directors, the Selling Shareholder (i.e. Rivendell PE LLC) and the BRLMs any of their affiliates or advisors make any representation as to its accuracy or completeness. The data used in these sources may have been re-classified by us for the purposes of presentation. Data from these sources may also not be comparable.

The extent to which industry and market data set forth in this Prospectus is meaningful depends on the reader’s familiarity with and understanding of the methodologies used in compiling such data. There are no standard data gathering methodologies in the industry in which we conduct our business, and methodologies and assumptions may vary widely among different industry sources. Accordingly, no investment decision should be made solely on the basis of such information. Such data involves risks, uncertainties and numerous assumptions and is subject to change based on various factors, including those disclosed in “*Risk Factors*” on page 22.

This Prospectus contains certain industry and market data and statements concerning our industry obtained from ICRA Report which is subject to the disclaimer mentioned below. Further ICRA Limited, vide their letter dated March 15, 2021 (“**Letter**”) has accorded their no objection and consent to use the ICRA Report. ICRA Limited, vide their Letter has also confirmed that they are an independent agency, and confirmed that ICRA Limited is not related to our Company, our Directors, our Promoters or our Key Managerial Personnel.

*Disclaimer:*

*“All information contained in the Report has been obtained by ICRA from sources believed by ICRA to be accurate and reliable. Although reasonable care has been taken to ensure that the information therein is true, such information is provided ‘as is’ without any warranty of any kind, and in particular, makes no representation or warranty, express or implied, as to the accuracy, timeliness or completeness of any such information. All information contained therein must be construed solely as statements of opinion and not any recommendation for investment. ICRA shall not be liable for any losses incurred by users from any use of the Report or its contents. Also, ICRA may provide credit rating and other permissible services to the Company at arms-length basis.”*



## FORWARD-LOOKING STATEMENTS

This Prospectus contains certain “forward-looking statements”. These forward-looking statements generally can be identified by words or phrases such as “aim”, “anticipate”, “believe”, “goal”, “expect”, “estimate”, “intend”, “objective”, “plan”, “project”, “should”, “will”, “will continue”, “seek to”, “will pursue” or other words or phrases of similar import. Similarly, statements that describe our strategies, objectives, plans or goals are also forward-looking statements. All forward-looking statements are subject to risks, uncertainties and assumptions about us that could cause actual results to differ materially from those contemplated by the relevant forward-looking statement. For the reasons described below, we cannot assure investors that the expectations reflected in these forward-looking statements will prove to be correct. Therefore, investors are cautioned not to place undue reliance on such forward-looking statements and not to regard such statements as a guarantee of future performance.

Actual results may differ materially from those suggested by the forward-looking statements due to risks or uncertainties associated with the expectations with respect to, but not limited to, regulatory changes pertaining to the industry in which our Company has businesses and our ability to respond to them, our ability to successfully implement our strategy, our growth and expansion, technological changes, our exposure to market risks, general economic and political conditions in India and globally which have an impact on our business activities or investments, the monetary and fiscal policies of India, inflation, deflation, unanticipated turbulence in interest rates, foreign exchange rates, equity prices or other rates or prices, the performance of the financial markets in India and globally, changes in laws, regulations and taxes and changes in competition in our industry. Important factors that could cause actual results to differ materially from our expectations include, but are not limited to, the following:

- Inability to meet obligations under debt financing arrangements;
- Enforcement of the security in the event of failure to service debt obligations;
- Our business is dependent on the performance of the automotive sector globally, including in our key markets such as India, US, Europe;
- Our business largely depends upon our top ten customers and the loss of such customers or a significant reduction in purchases by such customers will have a significantly adverse impact on our business;
- The COVID-19 pandemic, or a similar public health threat, could adversely affect our business, financial condition, and results of operations;
- Failure to identify and understand evolving industry trends and preferences;
- Failure to sustain or manage our growth; and
- Failure to compete effectively.

For a further discussion of factors that could cause our actual results to differ from our expectations, see “*Risk Factors*”, “*Our Business*” and “*Management’s Discussion and Analysis of Financial Condition and Results of Operations*” on pages 22, 111 and 224, respectively. By their nature, certain market risk disclosures are only estimates and could be materially different from what actually occurs in the future. As a result, actual gains or losses could materially differ from those that have been estimated.

Forward-looking statements reflect our views as of the date of this Prospectus and are not a guarantee of future performance. These statements are based on our management’s beliefs and assumptions, which in turn are based on the currently available information. Although we believe the assumptions upon which these forward-looking statements are based are reasonable, any of these assumptions could prove to be inaccurate, and the forward-looking statements based on these assumptions could be incorrect. None of our Company, Directors, the Selling Shareholder (i.e. Rivendell PE LLC), and the BRLMs or their respective affiliates have any obligation to update or otherwise revise any statements reflecting circumstances arising after the date hereof or to reflect the occurrence of underlying events, even if the underlying assumptions do not come to fruition.

In accordance with regulatory requirements, our Company will ensure that investors in India are informed of material developments from the date of filing of this Prospectus until the date of Allotment. The Selling Shareholder (i.e. Rivendell PE LLC) will ensure that investors are informed of material developments in relation to the statements and undertakings expressly made by the Selling Shareholder (i.e. Rivendell PE LLC) in this Prospectus until the date of Allotment.

## SUMMARY OF THE OFFER DOCUMENT

This section is a general summary of certain disclosures included in this Prospectus and is not exhaustive, nor does it purport to contain a summary of all the disclosures in this Prospectus or all details relevant to prospective investors. This summary should be read in conjunction with, and is qualified in its entirety by, the more detailed information appearing elsewhere in this Prospectus, including the sections titled “Risk Factors”, “Our Business”, “Industry Overview”, “Capital Structure”, “The Offer” and “Outstanding Litigation and Material Developments” beginning on at pages 22, 111, 95, 64, 54 and 255 respectively of this Prospectus.

### Summary of Business

We are one of the top five forging companies in India (*Source: ICRA Report*) and a manufacturer and global supplier of hot rolled forged and machined bearing rings, and automotive components for segments of vehicles including passenger vehicles, commercial vehicles, two-wheeler vehicles and off-highway vehicles and electric vehicles. We supply domestically and internationally to large marquee customers including some of the leading bearing manufacturing companies, tier-I suppliers to global auto companies and auto OEMs. We are one of the key manufacturers of bearing rings in India (*Source: ICRA Report*) and cater to most of the leading bearing companies in India.

### Summary of Industry

The Indian bearing market is estimated at ₹ 12,000 crore and it constitutes less than 4% of the global bearing demand. In terms of consumption, about 60% requirement is met through domestic production while the remaining is met through imports. Bearing Rings form one of the most critical and largest raw material cost for the bearings sector and at ~₹ 2,200 crores, the industry contributes ~18.3% of the size of domestic bearing market. (*Source: ICRA Report*)

### Promoters

Our Promoters are Rupesh Dayashankar Madeka, Jiten Dayashankar Madeka, Manesh Dayashankar Madeka, Pinakin Dayashankar Madeka and Bhautik Dayashankar Madeka.

### Offer Size

Offer	8,122,222 Equity Shares, aggregating to ₹ 7,310 million
of which	
Fresh Issue <sup>(1)</sup>	622,222 Equity Shares, aggregating to ₹ 560 million
Offer for Sale <sup>(2)</sup>	7,500,000 Equity Shares, aggregating up to ₹ 6,750 million by the Selling Shareholder (i.e. Rivendell PE LLC)

(1) Our Board has authorised the Offer, pursuant to their resolution dated March 12, 2021. Our Shareholders have authorised the Offer pursuant to their resolution dated March 12, 2021. Our Board has approved the Fresh Issue size pursuant to its resolution dated March 12, 2021 read with resolution dated July 18, 2021.

(2) The Equity Shares being offered by the Selling Shareholder (i.e. Rivendell PE LLC) have been held for a period of at least one year immediately preceding the date of the Draft Red Herring Prospectus with the SEBI and are eligible for being offered for sale pursuant to the Offer in terms of the SEBI ICDR Regulations. For details of authorizations received for the Offer for Sale, see “Other Regulatory and Statutory Disclosures” beginning on page 260.

### Selling Shareholder

The Selling Shareholder is Rivendell PE LLC who is offering for sale of 7,500,000 Equity Shares in the Offer. Below is the pre-Offer and post-Offer shareholding of Rivendell PE LLC, the Selling Shareholder.

Name	Pre-Offer Shareholding	Post-Offer Shareholding
Rivendell PE LLC	10,914,423	3,414,423

## Objects of the Offer

The Net Proceeds are proposed to be used in accordance with the details provided in the following table:

Particulars	Amount (In ₹ million)
Funding long-term working capital requirements	450
General corporate purposes <sup>(1)</sup>	79.57
<b>Net Proceeds</b>	<b>529.57</b>

<sup>(1)</sup> To be determined on finalisation of the Offer Price and updated in the Prospectus. The amount utilised for general corporate purposes shall not exceed 25% of the Gross Proceeds.

## Pre-Offer Shareholding of Promoters, Promoter Group and Selling Shareholder

S. No.	Category of Shareholders	No. of Equity Shares	% of total paid up Equity Share capital
<b>A.</b>	<b>Promoters</b>		
1.	Rupesh Dayashankar Madeka	2,518,303	9.46
2.	Manesh Dayashankar Madeka	2,755,098	10.35
3.	Pinakin Dayashankar Madeka	2,981,892	11.21
4.	Bhautik Dayashankar Madeka	2,213,811	8.32
5.	Jiten Dayashankar Madeka	2,518,303	9.46
	Total (A)	<b>12,987,407</b>	<b>48.80</b>
<b>B.</b>	<b>Promoter Group</b>		
6.	Ashok Dayashankar Madeka	863,257	3.24
7.	Paresh Dayashankar Madeka	72,000	0.27
8.	Mihir Rupeshkumar Madeka	472,181	1.77
9.	Hemal Paresh Madeka	357,460	1.34
10.	Sanjay Bhagwanji Bole	472,181	1.77
11.	Bharat Jiten Madeka	472,181	1.77
	Total (B)	<b>2,709,260</b>	<b>10.18</b>
<b>C.</b>	<b>Selling Shareholder</b>		
12.	Rivendell PE LLC	10,914,423	41.01%
	<b>Total (A+B+C)</b>	<b>26,611,090</b>	<b>100.00%</b>

## Summary of Financial Information

(in ₹ million except per share data)

Particulars	As on March 31, 2021 and for the Fiscal ended March 31, 2021	As on March 31, 2020 and for the Fiscal ended March 31, 2020	As on March 31, 2019 and for the Fiscal ended March 31, 2019
Equity share capital	239.81	239.81	239.81
Other equity	3,327.52	2,441.24	1,913.63
Net worth	3,567.33	2,681.05	2,153.44
Revenue from operations	6,163.32	6,659.94	9,043.23
Restated profit for the year	869.55	529.41	590.41
Restated basic earnings per share of ₹ 10 each fully paid up	36.26	22.08	24.62
Restated diluted earnings per share of ₹10 each fully paid up	35.96	22.08	24.62
Net asset value per equity share*	148.76	111.80	89.80
Total borrowings <sup>^</sup>	2,494.91	2,589.53	3,851.68

\* Net asset value (per Equity Share) means total equity as restated divided by number of Equity Shares outstanding at the end

of the year.

^ 'Total borrowings' is calculated as borrowings under total non-current borrowings, plus short term borrowings, plus current maturities of long-term debts.

### Qualifications of the Auditors

The Restated Financial Statements does not contain any qualification.

### Summary of Outstanding Litigation and Material Developments

A summary of outstanding litigation proceedings involving our Company, our Promoters, our Directors, and our Group Company as disclosed in this Prospectus as per the Materiality Policy, is provided below:

(₹ in million)

Type of Proceedings	Number of cases	Amount*
<b>Cases against our Company</b>		
Criminal proceedings	Nil	Nil
Action by regulatory/statutory authorities	Nil	Nil
Tax proceedings	11	148.91
Material civil litigation	Nil	Nil
<b>Total</b>	<b>11</b>	<b>148.91</b>
<b>Cases by our Company</b>		
Criminal proceedings	Nil	Nil
Action by regulatory/statutory authorities	Nil	Nil
Tax proceedings	Nil	Nil
Material civil litigation	Nil	Nil
<b>Total</b>	<b>Nil</b>	<b>Nil</b>
<b>Cases involving our Directors</b>		
Criminal proceedings	Nil	Nil
Action by regulatory/statutory authorities	Nil	Nil
Tax proceedings	5	Not quantifiable
Material civil litigation	Nil	Nil
<b>Total</b>	<b>5</b>	<b>Nil</b>
<b>Cases involving our Promoters</b>		
Criminal proceedings	Nil	Nil
Action by regulatory/statutory authorities	Nil	Nil
Tax proceedings	10	Not quantifiable
Material civil litigation	Nil	Nil
Disciplinary action including penalty imposed by SEBI or stock exchanges	Nil	Nil
<b>Total</b>	<b>10</b>	<b>Not Quantifiable</b>
<b>Cases against our Group Company that may have a material impact on the Company</b>		
Outstanding litigation that may have a material impact on our Company	Nil	Nil
<b>Total</b>	<b>Nil</b>	<b>Nil</b>

\*Amount to the extent quantifiable

For further details of the outstanding litigation proceedings, see "Outstanding Litigation and Material Developments" beginning on page 255.

## Risk Factors

Please see “Risk Factors” beginning on page 22.

## Contingent liabilities

As of March 31, 2021, contingent liabilities as per Ind AS 37 as indicated in our Restated Financial Statements are as follows:

		<i>(in ₹ million)</i>
S. No.	Particulars	As on March 31, 2021
(i)	<b>Contingent liabilities</b>	
	Disputed Income tax/ Sales tax/ Service tax	
	Income tax with respect to matters relating to disallowance of additional depreciation, disallowance of forex loss, disallowance of foreign commission and disallowance of other expenditure for the assessment years 2005-06 to 2017-18 in respect of which the Company has filed an appeal with higher authorities	138.73
	For non receipt of the required forms and non acceptance of the companies claim of certain sales as an exempted sales and related matters	0.25
	Service tax with respect to the matters decided against the company in respect of which the company has filed appeal with higher authorities	1.41

*The management based on the assessment, believes that the outcome of these contingencies will be favourable, but not probable and accordingly no provision has been recognised in the financial statement. There are numerous interpretative issues relating to the Supreme Court judgement on provident fund dated February 28, 2019 (“Judgement”). The Company has adopted the basis as mentioned in the Judgement prospectively with effect from April 1, 2019.*

For further details of contingent liabilities as per Ind AS 37 as on March 31, 2021, see “Management’s Discussion and Analysis of Financial Condition and Results of Operations” and “Outstanding Litigation and Material Developments” and “Financial Statements” beginning on pages 224, 255 and 161, respectively.

## Summary of Related Party Transactions as per Ind AS 24

	<i>(₹ in million)</i>		
	Year ended March 31, 2021	Year ended March 31, 2020	Year ended March 31, 2019 (Proforma)
<b>Transactions during the year</b>			
<b>Interest Income</b>			
Manesh Dayashankar Madeka	0.92	1.10	1.10
Bhautik Dayashankar Madeka	0.69	0.83	0.83
Mihir Rupeshkumar Madeka	0.69	0.83	0.83
Fillenpac Industries Private Limited	-	-	0.65
<b>Remuneration paid</b>			
Salary allowances and bonus *			
Manesh Dayashankar Madeka	9.60	10.75	11.04
Bhautik Dayashankar Madeka	9.36	9.41	8.28
Mihir Rupeshkumar Madeka	8.40	8.06	6.90
Hemal Paresh Madeka	6.60	6.72	6.90
Bharat Jiten Madeka	8.40	8.06	6.90
Paresh Dayashankar Madeka	0.60	0.67	0.69

	Year ended March 31, 2021	Year ended March 31, 2020	Year ended March 31, 2019 (Proforma)
Rupesh Dayashankar Madeka	7.20	6.72	5.52
Jiten Dayashankar Madeka	7.20	6.72	5.52
Ashok Dayashankar Madeka	4.80	5.38	4.35
Pinakin Dayashankar Madeka	7.20	6.72	5.52
Sanjay Bhagwanji Bole	1.50	1.68	1.73
Hardik Dhimantbhai Gandhi	0.17	0.17	0.17
Hiren Dilipbhai Doshi (w.e.f March 12, 2021)	0.19	-	-
<b>Scrap sales</b>			
Rapid Cut	3.31	2.90	1.32
<b>Rental income</b>			
Rapid Cut	0.42	0.42	0.18
<b>Labour charges</b>			
Rapid Cut	5.90	7.20	5.22
<b>Closing balance</b>			
<b>Trade Receivable</b>			
Fillenpac Industries Private Limited	-	6.19	7.50
Rapid cut	-	0.03	-
<b>Trade Payable</b>			
Rapid cut	0.36	-	0.93
<b>Remuneration payable</b>			
Manesh Dayashankar Madeka	0.09	1.95	-
Bhautik Dayashankar Madeka	-	1.71	-
Mihir Rupeshkumar Madeka	-	1.46	-
Hardik Dhimantbhai Gandhi	0.01	0.01	0.01
Hemal Paresh Madeka	-	1.22	-
Bharat Jiten Madeka	-	1.46	-
Paresh Dayashankar Madeka	0.22	0.12	-
Rupesh Dayashankar Madeka	0.02	1.22	-
Jiten Dayashankar Madeka	3.40	1.22	-
Ashok Dayashankar Madeka	6.31	0.98	0.28
Pinakin Dayashankar Madeka	-	1.22	-
Sanjay Bhagwanji Bole	0.01	0.13	-
Hiren Dilipbhai Doshi (w.e.f. March 12, 2021)	0.29	-	-
<b>Advance Remuneration</b>			

	Year ended March 31, 2021	Year ended March 31, 2020	Year ended March 31, 2019 (Proforma)
Manesh Dayashankar Madeka	-	-	0.80
Bhautik Dayashankar Madeka	-	-	0.70
Mihir Rupeshkumar Madeka	-	-	0.60
Hemal Paresh Madeka	-	-	0.50
Bharat Jiten Madeka	-	-	0.60
Paresh Dayashankar Madeka	-	-	0.05
Rupesh Dayashankar Madeka	-	-	0.50
Jiten Dayashankar Madeka	-	-	0.50
Pinakin Dayashankar Madeka	-	-	0.50
Sanjay Bhagwanji Bole	-	-	0.13
<b>Loan</b>			
Manesh Dayashankar Madeka	-	10.00	10.00
Bhautik Dayashankar Madeka	-	7.50	7.50
Mihir Rupeshkumar Madeka	-	7.50	7.50
M/s. Fillenpac Industries Private Limited	-	-	8.30
<b>Interest receivable</b>			
Manesh Dayashankar Madeka	-	-	1.10
Bhautik Dayashankar Madeka	-	-	0.83
Mihir Rupeshkumar Madeka	-	-	0.83
M/s. Fillenpac Industries Pvt Ltd	-	-	0.64

\* The remuneration does not include gratuity since the same is calculated for all the employees of the Company as a whole.

For details of the related party transactions in accordance with Ind AS 24, see “Related Party Transactions” on page 159.

### Financing Arrangements

There have been no financing arrangements whereby our Promoters, members of the Promoter Group, our Directors and their relatives have financed the purchase by any other person of securities of our Company during a period of six months immediately preceding the date of this Prospectus.

### Weighted average price at which the Equity Shares were acquired by our Promoters and the Selling Shareholder in the one year preceding the date of this Prospectus

The Selling Shareholder (i.e. Rivendell PE LLC) has not acquired any Equity Shares in the one year preceding the date of this Prospectus.

The weighted average price at which the Equity Shares were acquired by our Promoters in the one year preceding the date of this Prospectus is:

S. No.	Name of Promoter	Weighted average price of acquisition per Equity Share (in ₹)
1.	Rupesh Dayashankar Madeka	10.00
2.	Jiten Dayashankar Madeka	10.00
3.	Manesh Dayashankar Madeka	7.04
4.	Pinakin Dayashankar Madeka	6.66
5.	Bhautik Dayashankar Madeka	4.84

For further details, see “*Capital Structure*” beginning on page 64.

#### **Average Cost of Acquisition**

The average cost of acquisition per Equity Share by for our Promoters and the Selling Shareholder (i.e. Rivendell PE LLC), as on the date of this Prospectus is:

S. No.	Category of Shareholders	Average Cost of Acquisition per Equity Share (in ₹)
<b>A.</b>	<b>Promoters</b>	
1.	Rupesh Dayashankar Madeka	18.81
2.	Jiten Dayashankar Madeka	18.81
3.	Manesh Dayashankar Madeka	17.34
4.	Pinakin Dayashankar Madeka	17.05
5.	Bhautik Dayashankar Madeka	15.08
<b>B.</b>	<b>Selling Shareholder</b>	
6.	Rivendell PE LLC	149.16

For further details, see “*Capital Structure*” beginning on page 64.

#### **Details of pre-Offer Placement**

Our Company does not contemplate any issuance or placement of Equity Shares from the date of this Prospectus till the listing of the Equity Shares.

#### **Issue of Equity Shares for consideration other than cash in the last one year**

Our Company has not issued any Equity Shares for consideration other than cash in the one year preceding the date of this Prospectus.

#### **Split / Consolidation of Equity Shares in the last one year**

Our Company has not undertaken a split or consolidation of the Equity Shares in the one year preceding the date of this Prospectus.



## SECTION II - RISK FACTORS

*An investment in the Equity Shares involves a high degree of risk. You should carefully consider all the information in this Prospectus, including the risks and uncertainties described below, before making an investment decision in the Equity Shares. If any of the following risks or any of the other risks and uncertainties actually occur, our business, prospects, cash flows, financial condition and results of operations could suffer, the trading price of our Equity Shares could decline, and you may lose all or part of your investment. These risks and uncertainties are not the only issues that we face. Additional risks and uncertainties not presently known to us or that we currently believe to be immaterial may also have an adverse effect on our business, results of operations, cash flows and financial condition. To obtain a more detailed understanding of our business and operations, please read this section in conjunction with the sections titled "Our Business" and "Management's Discussion and Analysis of Financial Condition and Results of Operations" on pages 111 and 224, respectively, as well as the other financial and statistical information contained in this Prospectus.*

*The financial and other related implications of risks concerned, wherever quantifiable, have been disclosed in the risk factors below. However, there are risk factors the potential effects of which are not quantifiable and therefore no quantification has been provided with respect to such risk factors. In making an investment decision, prospective investors must rely on their own examination of us and the terms of this Offer, including the merits and risks involved.*

*This Prospectus also contains forward-looking statements that involve risks and uncertainties. Our actual results could differ materially from those anticipated in these forward-looking statements as a result of certain factors, including the considerations described below and elsewhere in this Prospectus. See section titled "Forward-Looking Statements" on page 14.*

### INTERNAL RISK FACTORS

#### **1. We have defaulted in payment of certain loans in the past, and had approached CDR Cell for restructuring debt in FY 2013**

We have, in the past, defaulted in payment of certain loan facilities and restructured term debt amounted to ₹ 4,870.20 million and availed from Corporation Bank, Oriental Bank of Commerce, Union Bank of India, Bank of Baroda, Bank of India and Indian Overseas Bank. Our Company approached the lenders to restructure the debts and the CDR forum approved the restructuring of debt on January 9, 2013. In terms of the Restructuring Agreements, the Facilities are secured by encumbrance on the entire fixed and current assets of our Company, pledge on the shareholding of our Promoters and members of our Promoter Group including requirement of creation of pledge on any new securities issued to Promoters and members of our Promoter Group, personal guarantees issued by our Promoters and members of our Promoter Group, and corporate guarantees issued by members of our Promoter Group, namely, Rolex Properties Private Limited and Madeka Properties Private Limited. Apart from the above, the Restructuring Agreements confers certain rights on CDR Group Lenders (namely Corporation Bank, Oriental Bank of Commerce, Union Bank of India, Bank of Baroda, Bank of India, Indian Overseas Bank and IDBI Bank), including, right to appoint nominee directors to our Board, acquiring security over any immovable properties acquired by the Company and right of recompense. We will need to engage with CDR Group Lenders to ascertain our liability and quantum of liability if any under right of recompense clause of the CDR scheme. Further, as a part of the CDR Package, our Promoters and certain members of the Promoter Group were required to bring in additional capital. Our Promoters and certain members of our Promoter Group had subscribed to NCRPS to satisfy the requirement.

Any requirements imposed by the CDR Group Lenders on us during the subsistence of the CDR Package may adversely impact the flexibility available to the management in running the business including through limitations on seeking additional financing, increase our cost of financing, or may lead to additional liabilities on our Company. As on March 31, 2021, the percentage of the restructured term debt still due is 6.89% and amounted to ₹ 335.74 million. This outstanding amount has to be repaid in quarterly instalments. In the event of a default of the payment obligations under the Restructuring Agreements, the CDR Group Lenders have *inter-alia* the (i) right to enter upon and take possession of our assets, transfer the assets of our Company by way of lease or leave and license, (ii) right to convert the whole of the outstanding amount of the borrowings or 20% of rupee equivalent of the defaulted amount into fully paid up Equity Shares of our Company, (iii) right to review the management set-up of our Company and require our Company to restructure as considered suitable by the CDR Group Lenders,

(iv) right to modify or terminate any existing selling/ purchasing arrangements, and (v) remove the whole time directors of our Company and appoint nominee directors who can exercise such powers and duties as approved by the CDR Group Lenders. For further details, see “*History and Certain Corporate Matters - Defaults or rescheduling/restructuring of borrowings*” on page 133 of this Prospectus for details regarding CDR related agreements.

Further, in the past, our Company has delayed in repayment of loans to financial institutions and banks with respect to our borrowings for certain periods including up to Fiscal 2019 and as a consequence of the same we may be restricted in taking some actions including buy-back of securities.

**2. *We are heavily dependent on the performance of the automotive sector in India, Europe, North America, Latin America and some part of Asia. Any adverse changes in the conditions affecting these markets can adversely impact our business, results of operations, cash flows and financial condition.***

For Fiscal 2021, Fiscal 2020, and Fiscal 2019, our sales which constituted auto-components was ₹ 2,373.65 million, ₹ 2,660.78 million, and ₹ 2,944.13 million which as a percentage of our sales of goods was 41.77%, 43.20%, and 35.52% respectively. Our business from automotive industry is directly related to vehicle sales and production levels across various segments. Automotive sales and production are highly cyclical and depend on general economic conditions and other factors, including consumer spending and preferences, as well as changes in interest rate levels, consumer confidence and fuel costs. Our sales are also affected by inventory levels and production levels of automotive manufacturers. We cannot predict when manufacturers will decide to increase or reduce inventory levels or whether new inventory levels will be in line with historical inventory levels. This may result in variability in our sales and financial condition. Uncertainty regarding inventory levels may be exacerbated by favourable consumer financing programs initiated by manufacturers, which may accelerate sales that would otherwise occur in future periods. The sales, volumes and prices for vehicles are influenced by the cyclical and seasonality of demand for these products. The automotive industry has been cyclical in the past and we expect this cyclical to continue. For instance, in the recent past, the Indian automotive industry had been adversely impacted by factors such as slow-down in the overall economy, higher insurance costs, the scheduled adoption of BS-VI norms and COVID-19. Any sustained weakness in automobile sales will adversely impact demand for components manufactured and supplied by our Company and will materially impact our business outlook, result of operations, cash flows and financial condition. Any significant reduction in vehicle sales and production by our customers may have a material adverse effect on our business, financial condition, cash flows and results of operations.

**3. *Our loan agreements requires our Promoters and certain members of our Promoter Group to pledge Equity Shares and NCRPS of our Company with lenders. A breach by our Company of certain covenants under the financing agreements may entitle these lenders to exercise their rights under the financing agreements and reduce the shareholding of our Promoters and certain members of the Promoter Group, which may adversely affect our business.***

Our Promoters and certain members of our Promoter Group are required to pledge their entire shareholding of Equity Shares and NCRPS as security for the loans availed by our Company. As on the date of this RHP, the aggregate shareholding of the Promoters and Promoter Group is 58.99% comprising of the total shareholding of the Promoters being 48.80% of our existing paid up equity capital and the total shareholding of the promoter group being 10.18% of our existing paid up equity capital. The entire NCRPS holding of the promoters (i.e. 13,605,863 NCRPS) will be pledged with the Consortium Lenders in accordance with the terms of pledge agreement.

Our lenders have agreed to release their pledge over certain portion of such securities to help our Company meet the requirements toward minimum promoters contribution, subject to the terms and condition of the CDR Package. Pursuant to the Waiver Letters, the Consortium Lenders have removed pledge on 58,65,107 Equity Shares held by Promoters to ensure compliance with minimum promoter contributions as per SEBI ICDR Regulations, however, any excess Equity Shares which will not form part of minimum promoter contribution will be required to be locked-in and pledged by the Promoters with the Consortium Lenders in terms of CDR Package and applicable law. The exact number of Equity Shares to be pledged with the Consortium Lenders will be finalized post determination of the number of Equity Shares to be issued pursuant to the Fresh Offer.

Any default under the financing agreements pursuant to which these securities have been pledged will entitle the lenders, to enforce the pledge over these securities. If these pledges are enforced, the shareholding of our Promoters and certain members of our Promoter Group in our Company may be reduced and we may face certain impediments in taking decisions and the lenders will be entitled to attend general meetings of our Company, and exercise voting rights in respect of the pledged Equity Shares and NCRPS. For further details on such loan agreements, see “*History and Certain Corporate Matters - Defaults or rescheduling/restructuring of borrowings*” beginning on page 133.

As a result of the above, we may not be able to conduct our business or implement our strategies as currently planned, which may adversely affect our business, cash flows and prospects.

**4. *Any shortages, slowdown or shutdown in our manufacturing operations may lead to under-utilization at our existing manufacturing facilities which could have an adverse effect on our business, results of operations, cash flows and financial condition.***

We manufacture bearing rings and auto-component products in our various manufacturing units situated at Rajkot, Gujarat. Our capacity utilization is dependent upon our ability to optimally manage our manufacturing facilities, which are subject to various operating risks, including those beyond our control, such as the breakdown and failure of equipment or industrial accidents, severe weather conditions and natural disasters. For instance, our capacity utilization for forging was 33.48%, 32.92%, and 50.01%, for Fiscal 2021, 2020, and 2019, respectively. For details on production capacity of our forging lines, please refer to page no. 111 of this RHP. Further, there are no instances of any major interruption of operations during last three years. However, any significant malfunction or breakdown of our machinery may entail repair and maintenance costs and cause delays in our operations. If we are unable to repair malfunctioning machinery in a timely manner or at all, our facilities may not be able to operate at desired utilization levels or our operations may be suspended until we procure machinery to replace the same.

Our manufacturing process requires a substantial amount of electricity and we largely depend on state electricity supply for our power requirements. For Fiscal 2021, 2020, and 2019, our power and fuel expenses amounted to ₹ 520.55 million, ₹ 541.84 million, and ₹ 714.89 million which constituted 8.45%, 8.14%, and 7.91% of our revenues from operations in the respective years. We also generate power by harnessing wind energy and solar energy for optimization of our electricity costs. However, such generation is highly dependent on weather conditions. Unfavourable weather conditions, underdeveloped infrastructure, change in government regulations or equipment failure could impair the effectiveness of solar and wind power equipment, reduce their output beneath their rated capacity; require the shutdown of key equipment; impede the operation of solar and wind power equipment; and could result in extra costs and may adversely affect our financial condition.

While we have not been affected by any disruptions in the past on account of electricity supply, in the event of any such disruption, our ability to continue production could be hampered or delayed. Inability to effectively respond to such events and rectify any disruption, in a timely manner and at an acceptable cost, could lead to slowdown or shut-down of our operations or the under-utilization of our manufacturing facility, which in turn may have an adverse effect on our business, results of operations, cash flows and financial condition.

**5. *The continuing impact of the outbreak of the COVID-19 could have a significant effect on our operations, and could negatively impact our business, revenues, financial condition, cash flows and results of operations.***

In late calendar 2019, COVID-19, commonly known as “novel coronavirus” was first reported in Wuhan, China. Since then, the virus had progressively spread globally to many countries. The outbreak of COVID-19 was recognized as a public health emergency of international concern on January 30, 2020 and as a pandemic by the WHO on March 11, 2020. In response to the COVID-19 outbreak, the governments of many countries, had/have taken preventive or protective actions, such as imposing country-wide lockdowns, as well as restrictions on travel and business operations. The Government of India had announced a nation-wide lockdown on March 24, 2020 and imposed several restrictions. While progressive relaxations have since been granted for movement of goods and people and cautious re-opening of businesses and offices, lockdowns may be re-introduced in the future. Certain countries, including India, have reinstated lockdown conditions due to a “second wave” of the COVID-19 outbreak and the discovery of new strains of the coronavirus, and the Central Government and State Governments may reinstate complete lockdown conditions or impose additional restrictions.

The global impact of the COVID-19 pandemic has been rapidly evolving and public health officials and government authorities have reacted by taking measures, including in the regions in which we operate, such as prohibiting people from assembling in heavily populated areas, instituting quarantines, restricting travel, issuing lockdown orders and restricting the types of businesses that may continue to operate, 'stay-at-home' orders, and enforcing remote working regulations. These measures led to a significant decline in economic activities.

The operations of the Company were impacted briefly, due to shutdown of factory following nationwide lockdown. The Company continues with its operations in line with directives from the authorities. We have monitored and considered the impact of known events arising from the COVID-19 pandemic, including with respect to our liquidity and going concern and recoverable values of assets. While we have not experienced significant financial losses in the past, however, the impact assessment is a continuing process given the uncertainties associated with its nature and duration. While there has been a decrease in our revenue and increase in our trade payables and receivables, there has been no material impact on the revenue, trade receivables and payables due to COVID-19 and there have been no instances of material changes/modifications in agreements with suppliers and customers due to COVID-19. For further details in changes in our revenues and trade payables and receivables in Fiscal 2021, please see "*Management's Discussion and Analysis of Financial Condition and Results of Operations – Summary of Results of Operations - Fiscal 2021 compared to Fiscal 2020*" and "*Management's Discussion and Analysis of Financial Condition and Results of Operations – Liquidity and Capital Resources – Cash Flows – Cash Flows from Operating Activities – Fiscal 2021*" on pages 244 and 247.

Going forward, the impact of the pandemic on our business, operations and financial performance in future may include, but are not limited to the following:

- our ability to travel, interact with potential customers, pursue partnerships and other business transactions;
- our inability to source key raw materials as a result of the temporary or permanent closure of the facilities of suppliers of our key raw materials;
- challenges across various parts of our supply chain network;
- a portion of our workforce being unable to work, including because of travel or government restrictions in connection with COVID-19, including stay at home order, which could result in a slowdown in our operations;
- our strategic projects/ proposed products becoming delayed;
- delays in orders or delivery of orders, which may negatively impact our cash conversion cycle and ability to convert our order backlog into cash;
- inability to collect full or partial payments from customers due to deterioration in customer liquidity;
- uncertainty as to what conditions must be satisfied before government authorities completely lift lockdown orders; and
- the potential negative impact on the health of our employees, particularly if a significant number of them are afflicted by COVID-19, could result in a deterioration in our ability to ensure business continuity during this disruption.

Further, we generate our revenues from different geographies due to exports. The effects of COVID-19 in India and the geographies we operate in may last for different duration or have different magnitude in different countries which may make it difficult for us to maintain normalised operations or may have an impact on our future growth.

The extent to which the COVID-19 impacts our business and results will depend on future developments, which are highly uncertain and cannot be predicted, such as new information which may emerge concerning the severity of the coronavirus and the actions taken globally to contain the coronavirus or treat its impact, among others. In addition, we cannot predict the impact that the COVID-19 pandemic will have on our customers, suppliers and other business partners, and each of their financial conditions and any material adverse effect on these parties could adversely impact us. Existing insurance coverage may not provide protection for all costs and/or losses that may arise from all such possible events. To the extent that the COVID-19 pandemic adversely affects our business and operations, it may also have the effect of heightening many of the other risks described in this "*Risk Factors*" section.

As a result of these uncertainties, the impact may vary significantly from that estimated by our management from time to time, and any action to contain or mitigate such impact, whether government-mandated or opted by us, may not have the anticipated effect or may fail to achieve its intended purpose altogether.

**6. *Our top 10 customers accounted for a substantial majority of our revenue.***

We are highly dependent on our top 10 customers for our revenue. For Fiscal 2021, 2020, and 2019, these customers have accounted 72.62%, 76.94%, and 65.56% of our revenue of operations out of which 5 customers are from India and 5 customers are from outside India. A few of our customers belong to the same corporate group and while the decision making for each of these customers is largely independent, any adverse action taken by any member of such group may impact our relations with other members of such customer group as well.

As a result of significant reliance on limited set of customers, we may face certain issues including pricing pressures. Further, the revenue from these customers may vary from year to year, making it difficult to forecast future business needs and the loss or significant decrease in the volume of business from one or more of our significant customers would have an adverse effect on our business, financial condition and cash flows. Any significant decreases in spending in the sectors our customers operate in, may accordingly reduce the demand for our bearing rings and auto-component products and adversely affect our business, financial condition, cash flows and results of operations. We may further be subject to counterparty credit risk and any delay in receiving payments or non-receipt of payments may adversely impact our results of operations. Further, our customers impose significant requirements on us including stringent quality requirements and delivery schedules. For instance, in the past we have been required to resort to significantly costlier modes of transportation to meet our delivery commitments and scrap materials which do not comply with the quality parameters set by our customers. Our inability to manage such requirements may have an adverse impact of our ability to retain such customers, our reputation and results from operations.

**7. *The demand of our products in foreign countries is subject to international market conditions and regulatory risks that could adversely affect our business and results of operations.***

We export our products to around 16 countries. For Fiscal 2021, 2020, and 2019, our revenue from operations from outside India as a percentage of revenue from operations were 56.12%, 53.82%, and 56.27%, respectively. Therefore, any adverse developments in the industries in which our customers operate outside India, could have an impact on our sales from exports. From time to time, tariffs, quotas and other non-tariff trade barriers may be imposed on our products in jurisdictions in which we sell such products. There can be no assurance that the jurisdictions where we seek to sell our products will not impose trade restrictions on us in future. We may also be prohibited from exporting to certain restricted countries that may be added to a sanctions list maintained by the Government of India or other foreign governments, such as the Specially Designated Nationals and Blocked Persons list maintained by the Office of Foreign Assets Control of the US Department of Treasury in the United States. There have been no instances of recall of its product, adverse government action with respect to its products or manufacturing facilities, or prohibition from the manufacturing or sale of its products in the last three years. However, going forward any such imposition of trade barriers may have an adverse effect on our results of operations, cash flows and financial condition.

Further, a large part of our exports and some of our raw material procurement is denominated in US dollars and Euro. While imports offer us a partial hedge, we are still exposed to the fluctuation in currencies and for the Fiscal 2021 foreign exchange differences (net) included in other income and exchange difference regarded as an adjustment to borrowing costs included in finance costs amounted to ₹ 100.32 million which amounted to 1.63% of our revenues from operations. For Fiscals 2020 and 2019, foreign exchange differences (net) included in other income and exchange difference regarded as an adjustment to borrowing costs included in finance costs amounted to gain/loss of ₹ (0.23) million, and ₹ 49.36 million and constituted (0.01%), and 0.55% of our revenues from operations respectively.

**8. *We have outstanding borrowings which may adversely affect our financial condition. Restrictive covenants in our financing agreements may limit our operations and financial flexibility and materially and adversely impact our financial condition, results of operations, cash flows and prospects.***

As of March 31, 2021, our Company had total borrowings of ₹ 2,494.91 million, comprising of non-current borrowings of ₹ 323.45 million, current borrowings of ₹ 1,835.72 million and current maturities of non-current

borrowings of ₹ 335.74 million. Our borrowings could have significant implications on our business and results of operations, including, inter alia:

- a portion of our cash flows may be used towards repayment of our existing debt, which will reduce the availability of our cash flows to fund working capital, capital expenditures, acquisitions and other general corporate requirements;
- our ability to obtain additional financing in the future at reasonable terms may be restricted;
- there could be a material adverse effect on our business, financial condition, cash flows and results of operations if we are unable to service our borrowings or otherwise comply with financial and other covenants specified in the financing agreements; and
- we may be limited in our ability to withstand competitive pressures and may have reduced flexibility in responding to changing business, regulatory and economic conditions.

We have delayed repayment of loans and interest in Fiscals 2018 and 2019 to financial institutions and banks to the extent of ₹1,032 million and ₹ 373.74 million, respectively and the delay in such repayments being for less than 110 days and 62 days, respectively, in each individual case. We cannot assure you that we will be able to make future payment of interest and repayment of borrowings in a timely manner or at all and that the relevant lenders will not impose, among others, default interest, penalties or termination of the facilities.

Our financing agreements contain certain restrictive covenants that limit our ability to undertake certain types of transactions, any of which could adversely affect our business, cash flows and financial condition. We are required to obtain prior approval from our lenders for, among other things:

- undertaking any new project, diversification, modernisation or substantial expansion of the existing manufacturing unit(s) of our Company;
- issuing any debentures, raising any loans, deposits from public, issuing equity or preference capital, changing the capital structure of our Company or creating any charge on assets or give any guarantees save and except for permitted borrowings;
- paying any commission to promoters, directors, managers or other persons for financial assistance obtained by our Company for the purpose of the existing manufacturing unit(s);
- creating any subsidiary or permitting any company to become our Company's subsidiary;
- undertaking or effecting any merger/demerger, consolidation, reorganisation, scheme of arrangement, reconstruction or compromise, including joint ventures, acquisitions, hive-offs or any other such deal of a similar nature;
- removing any person exercising substantial powers of management in the affairs of our Company;
- recognising or registering any transfer of shares in our Company's capital;
- making any investments by way of deposits, loans, share capital etc. in any concern;
- revaluating any assets at any time during the currency of the facilities;
- undertaking any major capital expenditure;
- effecting any change in the management set up of our Company; and
- declaring any dividend on the equity shares of our Company.

Under these agreements, we also require lender consents for undertaking an initial public offering of our Equity Shares including consequential corporate actions and we have obtained such consent from the lenders. As on date of this Prospectus, we have received consents from all such lenders. In the event of a breach or noncompliance of relevant terms of our financing arrangements, we may be required to seek waivers from the respective lenders for such breaches or non-compliances. We cannot assure you that we will be able to obtain such amendments or waivers on satisfactory terms, or at all, and the relevant lenders could, inter-alia, impose penal and default interests, accelerate the maturity of our obligations and declare all amounts payable in respect of the facility to be due and payable immediately or otherwise on demand. Further, during any period in which we are in default, we may be unable to obtain further financing or any refinancing of our debt could be at higher rates of interest with more onerous covenants. In addition, lenders may be able to sell our assets charged under such financing arrangements to enforce their claims. There can be no assurance that we would be able to persuade our lenders to grant extensions or refrain from exercising such rights which may adversely affect our operations and cash flows. During any period in which we are in default, we may be unable to raise, or face difficulties raising, further financing or generate sufficient cash to fund our liquidity requirements. We may also be forced to sell some or all of the assets charged with our lenders if we do not have sufficient cash or credit facilities to make repayments.

The land owned by the Company on which Unit I, Unit II and Unit III are located is mortgaged and in case of any default the lenders may proceed in accordance with the terms and conditions of the facility agreement. Any failure to meet our obligations under the debt financing agreements could have an adverse effect on our business, results of operations, cash flows and financial condition.

**9. We are subject to strict quality requirements and any product defect issues or failure by us to comply with quality standards could adversely affect our business, results of operations, cash flows and financial condition.**

The finished products delivered by us are required to comply with specifications and quality requirements as prescribed by our customers and may be subject to quality checks by our customers.

Our customers may have their own policies regarding product recalls and other product liability actions which may have an impact on their suppliers. As per the purchase arrangements with certain customers, the customers may inspect and audit production process and undertake quality checks of the product and packaging of components. In the event our products do not comply with the specification provided by our customers, our supplies may be rejected and we may also be required to reimburse our customer for any losses suffered as a result of our non-compliance.

We may face product liability or recall claims in the event that our products fail to meet the required quality standards or fail to perform as expected or such failure results, or is alleged to result, in bodily injury or property damage or both. While we try to minimize such risks by adherence to good manufacturing practices, finished product testing and through the commercial general liability insurance and product recall insurance availed by the Company, we cannot assure you that we will not be subjected to risk of legal proceedings and product liability claims being brought by our customers or other stakeholders, for various reasons including for defective products sold. Any product recall, product liability claim or adverse regulatory action may adversely affect our production levels, reputation, business, results of operations, cash flows and financial condition. There have been no instances of product recall or product liability claim in the last three years.

Additionally, prior to placing the orders, there is a detailed audit and review process that is undertaken by certain customers. This may involve inspection of our manufacturing facilities, review of the manufacturing processes, review of our financial capabilities, technical review of the specification of the proposed product and review of our supply-chain capabilities. Our ability to win new customers and retain our existing customers is dependent on our Company being able to conduct our operations in compliance with such requirements.

Further, we are required to incur expenses to maintain our quality assurance systems such as periodic checks, forming a separate team of employees responsible for quality and assurance across our manufacturing processes. We will continue to spend a portion of our future revenues to manage our product quality and to maintain our quality control, a failure of which may negatively impact our profitability.

**10. In the event our contingent liabilities materialize, our financial condition may be adversely affected.**

As of March 31, 2021, our aggregate contingent liabilities as per Ind AS 37 amounts to ₹ 140.39 million. In the event that any of these contingent liabilities materialize, our results of operation, cash flows and financial condition may be adversely affected. The details of such contingent liabilities as per Ind AS 37 as of March 31, 2021 are as follows:

<i>(in ₹ millions)</i>	
<b>Particulars</b>	<b>As on March 31, 2021</b>
<b>Contingent liabilities</b>	
Disputed Income tax/ Sales tax/ Service tax	
Income tax with respect to matters relating to disallowance of additional depreciation, disallowance of forex loss, disallowance of foreign commission and disallowance of other expenditure for the assessment years 2005-06 to 2017-18 in respect of which the Company has filed an appeal with higher authorities	138.73
For non receipt of the required forms and non acceptance of the companies claim of certain sales as an exempted sales and related matters	0.25
Service tax with respect to the matters decided against the company in respect of which the company has filed appeal with higher authorities	1.41

For further details on contingent liabilities as at March 31, 2021, as per Ind AS 37, see sections titled “*Financial Statements – Annexure VII – Notes to Restated Ind AS Summary Statements*” on page 183.

- 11. *We have substantial working capital requirements and if we are unable to secure adequate working capital on commercially reasonable terms, our business, financial condition, cash flows and results of operation may be adversely affected. Further, our ability to finance our capital expenditure is also subject to certain risks.***

Our business requires a substantial amount of working capital, primarily to maintain optimum inventory levels of raw materials, components which are work-in-progress and finished goods as well as to offer credit to our customers as is customary in our industry. Such working capital requirements are partially offset by the credit received by us from our suppliers. As of Fiscal 2021, Fiscal 2020, and Fiscal 2019, our Net Working Capital Requirements were ₹ 2,414.42 million, ₹ 2,120.36 million, and ₹ 2,589.68 million respectively. In the past, we have funded such working capital requirements through a combination of debt and internal accruals. For further details, please refer to section “*Objects of the Offer*” on page 80.

In the future, we may need to seek funding for our working capital needs through additional borrowings or securities offerings. We cannot assure you that such funding will be obtained in a timely manner, on satisfactory terms, or at all. Moreover, if we raise additional debt, our interest expense will increase and our debt covenants under our existing loans may be impacted. If we raise additional funds through the issuance of equity, your ownership interest in our Company will be diluted.

Our ability to finance our capital expenditures is also subject to a number of risks, contingencies and other factors, some of which are beyond our control, including borrowing or lending restrictions under applicable laws and the terms of our financial and other arrangements, our own profitability and liquidity and general economic and market conditions. Any inability to obtain sufficient financing, or any significant unanticipated expenses or cost escalations, could result in the delay or abandonment of our business and expansion plans. As a result, if adequate funding is not available to us in a timely manner and on commercially viable terms, it may have an adverse effect on our business, financial condition, cash flows, results of operations and prospects.

- 12. *Non-compliance with and changes in, safety, health and environmental laws and other applicable regulations in our manufacturing operations may adversely affect our business, cash flows, results of operations and financial condition.***

We are subject to laws and government regulations, including in relation to safety, health and environmental protection. These safety, health and environmental protection laws and regulations impose controls on air and water discharge, noise levels, storage handling, employee exposure to hazardous substances and other aspects of our manufacturing operations. We have made, and will continue to make capital and other expenditure to comply with environmental, health and safety standards. Further, any change in regulations may require us to make significant investments into our manufacturing facilities to comply with such revised requirements and we cannot assure you that such investments will yield desired returns. Any failure on our part to comply with any existing or future regulations applicable to us may result in legal proceedings being commenced against us, third party claims or the levy of regulatory fines. For further details, see section titled “*Outstanding Litigation and Material Development*” on page 255. A negative outcome in any such proceedings may adversely affect our business, cash flows, results of operations and financial condition.

Additionally, we cannot assure you that we will not be involved in future litigation or other proceedings, or be held liable in any litigation or proceedings including in relation to safety, health and environmental matters, the costs of which may be significant. While there has been no instance of suspension of operations in the last three years, however in the future, any accidents at our facilities may result in personal injury or loss of life, substantial damage to or destruction of property and equipment resulting in the suspension of operations. The loss or shutdown of our operations over an extended period of time could have an adverse effect on our business and operations.

- 13. *The geographical concentration of our manufacturing facilities may restrict our operations and adversely affect our business, cash flows and financial conditions.***



We conduct our manufacturing operations in Rajkot, Gujarat in India. Due to the geographic concentration of our manufacturing operations, our operations are susceptible to local and regional factors, such as system failures, economic and weather conditions, natural disasters, and demographic and population changes, and other unforeseen events and circumstances. Though, there have been no instances of major disruptions in the last three years, any such disruptions in the future could result in the damage or destruction of a significant portion of our manufacturing abilities, significant delays in shipments of our products and/or otherwise adversely affect our business, financial condition, cash flows and results of operations.

**14. *Our Logo is not registered, and failure to protect our intellectual property may adversely affect our reputation, goodwill and business operations.***

Our name and logo are not registered under the Trade Marks Act, 1999. Accordingly, we do not enjoy the statutory protections accorded to a registered trademark and are subject to the various risks arising out of the same, including but not limited to infringement or passing off our name and logo by a third party. Maintaining the reputation of our brands, corporate name, logo and the goodwill associated with these trademarks is material to our success. Substantial erosion in the perception of our brand and goodwill could have a material adverse effect on our business, financial condition, results of operations, cash flows and prospects. The use of our brand name or logo by third parties could adversely affect our reputation, which could in turn adversely affect our financial performance and the market price of the Equity Shares. Notwithstanding the precautions we take to protect our intellectual property rights, it is possible that third parties may copy or otherwise infringe on our rights, which may have an adverse effect on our business, results of operations, cash flows and financial condition.

Further, we may be susceptible to claims from third parties asserting infringement and other related claims. There have been no instances of third parties asserting infringement and other related claims against it in the last three years. However, in future if such claims or actions are asserted against us, we may be required to defend such claims, take corrective actions, change the name of our Company, enter into potentially expensive royalty or licensing agreements, or cease certain activities. Further, this may adversely impact our relationships with current or future customers, result in costly litigation and/or settlement, cause product shipment delays or stoppages, divert management's attention and resources and subject us to significant liabilities.

Furthermore, necessary licenses may not be available to us on satisfactory terms, if at all. Any of the foregoing could adversely affect our business, results of operations, cash flows and financial conditions. Moreover, we generate our revenues from different geographies due to exports, and any change in name of our Company may result in us being required to take additional efforts to intimate and seek updation of records with our customers and other stakeholders and us having to create and build our brand name internationally, which could result in significant costs and have an adverse impact on our business and operations. In addition, in certain cases, our customers share their intellectual property rights in the course of the product development process that we carry out for them. If our customer's intellectual property rights are misappropriated by our employees in violation of any applicable confidentiality agreements, our customers may seek damages and compensation from us. This could have an adverse effect on our business, financial condition, cash flows and results of operations and damage our reputation and relationships with our customers.

**15. *We may be unable to obtain, renew or maintain statutory and regulatory permits, licenses and approvals required to operate our business and operate our manufacturing facilities, which could have an adverse effect on our results of operations.***

We require certain statutory and regulatory permits, licenses, registrations and approvals to operate our business such as consents to establish and consolidated consent and authorisation from the state pollution control boards, registration and licenses issued under the Factories Act, fire safety licenses from municipal fire safety authorities, registration certificates issued under various labour laws, including contract labour registration certificates and licenses as well as various taxation related registrations, such as registrations for payment of goods and service tax and professional taxes. Our licenses, permits and approvals impose certain terms and conditions that require us to incur significant costs and *inter alia*, restrict certain activities. Further, many of these approvals require renewal from time to time and in the past, we have been unable to procure some of these approvals within stipulated timelines. For instance, we are in the process of obtaining factory license for our manufacturing facilities which had already expired. There can be no assurances that in future, we will be able to apply and obtain such renewals in a timely manner or that the approvals, licenses, permits and registrations may not be revoked in the event of any non-compliance with any terms or conditions imposed thereof.

We will also be required to regularly renew our material permits, licenses and approvals for our business, and to obtain new permits, licenses and approvals as may be required. The growth in size or scope of our business, expansion of our footprint in existing regions in which we operate and entry into new geographies may also expose us to regulatory regimes in which we have no prior direct experience and any expansion into new product areas could lead to our becoming subject to additional or different laws and regulations. Changes in laws and regulations, more stringent enforcement or alternative interpretation of existing laws and regulations in geographies in which we currently operate may make compliance with all applicable laws and regulations more challenging and could affect us adversely by reducing our freedom to do business, increasing our costs of doing business, or reducing our profitability. While we will endeavour to renew or obtain such approvals as required, there can be no assurance that the relevant authorities will issue any such approvals within our anticipated timeframe or at all. An inability to renew, maintain or obtain any material required permits, licenses or approvals may result in the interruption of our operations and have a material adverse effect on our business, cash flows, financial condition and results of operations. We cannot assure you that we will receive the approval in a timely manner. For further details in relation to our approvals, see section titled “*Government and Other Approvals*” at page 258.

**16. *We do not have firm commitment agreements with our customers. If our customers choose not to source their requirements from us, our business and results of operations may be adversely affected.***

We typically do not have firm commitment long-term supply agreements with most of our customers and instead rely on short term purchase orders to govern the volume and other terms of our sales of products, from our customers. The purchase orders we receive from our customers specify a price per unit, delivery schedule, and the quantities to be delivered, however, such orders may be amended or cancelled prior to finalisation, and should such an amendment or cancellation take place, it may adversely impact our revenue and production schedules.

Additionally, our customers have high and stringent standards for product quantity and quality as well as delivery schedules. Any failure to meet our customers’ expectations and specifications could result in the cancellation or non-renewal of contracts or purchase orders. There are also a number of factors, other than our performance that could cause the loss of a customer. Customers may also demand, among others, price reductions, set-off any payment obligations, require indemnification for themselves or their affiliates, change their outsourcing strategy by moving more work in-house, or replace their existing products with alternative products. In addition, our customers may shift the location of their plants, including to other countries, which may make our products lose their competitive edge. Any of these factors may have an adverse effect on our business, results of operations, cash flows and financial condition.

Accordingly, we face the risk that our customers might not place any order or might place orders of lesser than expected size or may even cancel existing orders or make change in their policies which may result in reduced quantities being manufactured by us. Cancellations, reductions or instructions to delay production (thereby delaying delivery of products manufactured by us) by a significant customer could adversely affect our results of operations by reducing our sales volume, as well as by possibly causing delay in our customers’ paying us for the order placed for purchasing the inventory with us which we would have manufactured for them. We may not find any customers or purchasers for the surplus or excess capacity, in which case we would be forced to incur a loss.

In addition, we make significant decisions, including determining the levels of business that we will seek and accept, production schedules, personnel requirements and other resource requirements, based on our estimates of customer orders. The changes in demand for their products (which are in turn manufactured by us) could reduce our ability to estimate accurately future customer requirements, make it difficult to schedule production and limit our ability to maximize utilization of our manufacturing capacity. The requirements of our customers are not restricted to one type of product and therefore variations in demand for certain types of products also requires us to make certain changes in our manufacturing processes thereby affecting our production schedules. We often increase staffing, increase capacity and incur other expenses to meet the anticipated demand of our customers, which could cause reductions in our margins if an order gets delayed or cancelled or modified.

**17. *Availability of raw materials and fluctuation in the prices of raw materials required for our products may adversely affect our business, financial condition, cash flows and results of operation.***

For our bearing rings and auto-component products, a major component of raw material is carbon steel, alloy steel and stainless steel.

For Fiscal 2021, 2020, and 2019, the cost of raw materials and components consumed was ₹ 3,165.94 million, ₹ 3,137.41 million, and ₹ 4,529.36 million, which as a percentage of our revenue from operations was 51.37%, 47.11%, and 50.09% respectively. Our raw materials pre-dominantly include carbon steel, alloy steel and stainless steel, the price of which has been volatile in the past. As a result, we continue to remain susceptible to the risks arising out of raw material price fluctuations which could result in declining operating margins.

Our Company has imported 24.5%, 27.95% and 21.12% of total raw material purchased in Fiscal 2021, 2020, and 2019, the cost of such raw materials was ₹ 1,011.62 million, ₹ 1,093.08 million, and ₹ 1,082.88 million respectively.

The automotive industry experienced significant volatility with respect to the price of raw materials in the recent past, primarily with respect to ferrous and non-ferrous metals. While we have been able to pass on increase in prices of raw material to our customers, there have also been occasions when we have been unable to pass on increases in raw materials prices to our customers. We cannot assure you that we will be able to mitigate the risk posed by such changes in raw material prices through pass-through arrangements with our customers and our inability to pass on any future variations in the prices of our raw materials either in part or completely may adversely impact our result from operations.

Further, each of our customer may specify a limited number of sources of raw-materials for a specific product and any slow-down or stoppage by such raw material suppliers may impact our ability to operate our facilities at optimum utilization, expose us to penalties due to delay and may require us to carry additional raw material inventories to tide over such disruptions. While we work with our customers to try and identify alternate sources of raw material and advance payments to cover for increased working capital requirements, we cannot assure you that such support will be forthcoming, in the absence of which our result of operations may be adversely impacted.

**18. *Our insurance coverage may not be sufficient or may not adequately protect us against all material hazards, which may adversely affect our business, results of operations, cash flows and financial condition.***

Our business involves inherent risks and hazards which may adversely affect our profitability, including amongst others, breakdown, failure or substandard performance of equipment, logistical disruptions, labour disturbances, employee frauds, and infrastructure failure. We could be held liable for accidents that occur at our manufacturing facility or otherwise arise out of our operations. In the event of personal injuries, fires or other accidents suffered by our employees or other people, we could face claims alleging that we were negligent, provided inadequate supervision or be otherwise liable for the injuries. We maintain insurance cover for our properties, and our policies cover, among others, protection from fire, special perils, burglary, machinery breakdown, public liability, product liability, product recall and financial loss. We also maintain a variety of employee insurance policies such as workmen compensation policy and group care policy. We also maintain insurance for our directors' and officers' liability as well as marine insurance policy in relation to movement of our products. Our insurance coverage for Fiscal 2021, Fiscal 2020, and Fiscal 2019, was ₹ 8,660 million ₹ 9,330 million, and ₹ 9,592 million, which was 2.49 times, 2.67 times, and 2.65 times respectively of the net fixed asset (excluding land values) and insurance coverage was ₹ 610 million ₹ 610 million, and ₹ 650 million, which was 0.85 times, 1.29 times, and 1.18 times respectively of inventories in hand (excluding raw materials and goods in transits).

While we believe that the insurance coverage which we maintain would be reasonably adequate to cover the normal risks associated with the operation of our business, we cannot assure you that the terms of our insurance policies will be adequate to cover any damage or loss suffered by us or that such coverage will continue to be available on reasonable terms or will be available in sufficient amounts to cover one or more large claims, or that the insurer will not disclaim coverage as to any future claim, or that any claim under the insurance policies maintained by us will be honoured fully, in part or on time, or that we have taken out sufficient insurance to cover all our losses.

In addition, our insurance coverage expires from time to time. We apply for the renewal of our insurance coverage in the normal course of our business, but we cannot assure you that such renewals will be granted in a timely manner, at acceptable cost or at all. To the extent that we suffer loss or damage for which we did not obtain or

maintain insurance, and which is not covered by insurance, exceeds our insurance coverage or where our insurance claims are rejected, the loss would have to be borne by us and our results of operations, cash flows and financial performance could be adversely affected. For further details on insurance arrangements, see section titled “*Our Business – Insurance*” on page 124.

**19. *We are dependent on a number of key personnel, including our senior management, and the loss of, or our inability to attract or retain, such persons could adversely affect our business, results of operations, cash flows and financial condition.***

Our performance depends largely on the efforts and abilities of our senior management, other key personnel and the performance and productivity of our operational managers. We believe that the inputs and experience of our Promoters, senior management and our key managerial personnel are valuable for the development of business and operations and the strategic directions taken by our Company. For details in relation to the experience of our key managerial personnel, see section titled “*Our Management*” on page 136. There is no assurance, however, that these individuals or any other member of our senior management team will not leave us or join a competitor. We cannot assure you that we will be able to retain these employees or find adequate replacements in a timely manner, or at all. For the financial year ended March 31, 2021, March 31, 2020 and March 31, 2019, our attrition rate was 8.31%, 8.76% and 9.43% respectively. We may require a long period of time to hire and train replacement personnel when qualified personnel terminate their employment with our Company. We may also be required to increase our levels of employee compensation more rapidly than in the past to remain competitive in attracting employees that our business requires. The loss of the services of such persons may have an adverse effect on our business and our results of operations.

The continued operations and growth of our business is dependent upon our ability to attract and retain personnel who have the necessary and required experience and expertise. Competition for qualified personnel with relevant industry expertise in India is intense. A loss of the services of our key personnel may adversely affect our business, results of operations, cash flows and financial condition.

**20. *We have availed certain loans which may be recalled by our lenders at any time.***

We have availed certain loans which may be recalled by the lenders namely, Corporation Bank, Oriental Bank of Commerce, Union Bank of India, Bank of Baroda, Bank of India, Indian Overseas Bank at any time. In the event that any lender seeks a repayment of any such loan, we may need to find alternative sources of financing, which may not be available on commercially reasonable terms, or at all. In addition, we may not have adequate working capital to undertake new projects or complete the ongoing projects. As a result, any such demand may affect our business, cash flows, financial condition and results of operations. At the end of Fiscal 2021, Fiscal 2020, and Fiscal 2019, the total amount of borrowings payable on-demand, cash credit from banks, were ₹ 171.10 million, ₹ 190.83 million, and ₹ 301.13 million which comprised of cash credit facilities and other working capital facilities utilized by our Company. In addition, we may not have adequate working capital to undertake new projects or complete the ongoing projects. As a result, any such demand may affect our business, cash flows, financial condition and results of operations. At the end of Fiscal 2021, Fiscal 2020, and Fiscal 2019, our total outstanding borrowings stood at ₹ 2,494.91 million, ₹ 2,589.53 million and ₹ 3,851.68 million, respectively.

**21. *We are subject to the risk of failure of, or weakness in, our internal control systems, which may have an adverse impact on our business, financial condition, cash flows, results of operations and prospects.***

In order to manage our growth effectively, we must implement, upgrade and improve our operational systems, procedures and internal controls on a timely basis. If we fail to implement these systems, procedures and controls on a timely basis, or if there are weaknesses in such internal controls that would result in inconsistent internal standard operating procedures, we may not be able to meet our customer’s needs, hire and retain new employees or operate our business effectively. Moreover, our ability to sustain our rate of growth depends significantly upon our ability to select and retain key managerial personnel, maintaining effective risk management policies and training managerial personnel to address emerging challenges. We cannot assure you that our existing or future management, operational and financial systems, procedures and controls will be adequate to support future operations or establish or develop business relationships beneficial to future operations.

**22. *We and certain of our Directors and Promoters are party to certain legal proceedings that, if decided***

*against us could have a material adverse effect on our reputation, business, prospects, cash flows, financial condition and results of operations.*

Our Company and certain of our Directors and Promoters are involved in direct and indirect proceedings. These proceedings are pending at different levels of adjudication before various courts. A summary of the litigation involving our Company, our Promoters and our Directors is set out below. The amounts involved in these proceedings have been summarized to the extent ascertainable and quantifiable.

***Litigation against our Company***

Nature of the cases	No. of cases outstanding	Amount involved (in ₹ million)
Criminal	Nil	Nil
Civil	Nil	Nil
Action by statutory or regulatory authorities	Nil	Nil
<b>Total</b>	Nil	Nil

***Litigation filed by our Company***

Nature of the cases	No. of cases outstanding	Amount involved (in ₹ million)
Criminal	Nil	Nil
Civil	Nil	Nil
Action by statutory or regulatory authorities	Nil	Nil
<b>Total</b>	Nil	Nil

***Tax proceedings involving our Company***

Nature of tax involved	Number of cases outstanding	Amount involved in such proceedings (in ₹ million)
Direct tax	6	138.78
Indirect Tax	5	10.13
<b>Total</b>	11	148.91

***Litigation involving our Directors***

Nature of the cases	No. of cases outstanding	Amount involved (in ₹ million)
Criminal	Nil	Nil
Civil	Nil	Nil
Action by statutory or regulatory authorities	Nil	Nil
Tax	5	Not quantifiable
<b>Total</b>	5	Not quantifiable

***Litigation involving our Promoters***

Nature of the cases	No. of cases outstanding	Amount involved (in ₹ million)
Criminal	Nil	Nil
Civil	Nil	Nil
Action by statutory or regulatory authorities	Nil	Nil
Disciplinary action	Nil	Nil
Tax	10	Not quantifiable
<b>Total</b>	10	Not quantifiable

### ***Litigation involving our Group Companies***

<b>Nature of the cases</b>	<b>No. of cases outstanding</b>	<b>Amount involved (in ₹ million)</b>
Pending cases which has a material impact on the Company	Nil	Nil
<b>Total</b>	Nil	Nil

For further details on these proceedings, see “*Outstanding Litigation and Material Developments*” beginning on page 255. While we believe that none of these legal proceedings may potentially affect our business significantly, we cannot assure you that these legal proceedings will be decided in our favour and any unfavourable decision may have an adverse effect on our reputation, business, prospects, financial condition, cash flows, results of operations and cash flows.

**23. *We rely on third parties to transport our products to our customers, and source raw materials for our manufacturing facilities and any disruption in our transportation arrangements or increases in transportation costs may adversely affect our business, cash flows, results of operations and financial condition.***

We rely on third parties, for transport of our products to our customers and transfer of raw materials to our manufacturing facilities. Any delay in the delivery of our products to our customers beyond our delivery commitments may lead to liquidated damages, penalties, loss of business and reputation. Further any significant delay in logistics of raw materials to our manufacturing facilities may result in the slowdown or shutdown of our operations. For instance, blockage of Suez Canal in March 2021 had led to delay in our consignment which adversely impacted our revenues from operations for Fiscal 2021.

In the absence of long-term arrangements, we are exposed to fluctuations in availability and cost of such transportation solutions. Also, if the terms offered to such logistic providers by our competitors are more favourable than those offered by us, they may decline to provide their services to us within the stipulated time or at all. We may also be affected by transport strikes, bad condition of roads, weather-related delays, or non-performance or deficiency in services, among others, which may affect our delivery schedules. If we are unable to secure alternate transport arrangements in a timely manner and at an acceptable cost, or at all, our business, results of operations, cash flows and financial condition may be adversely affected. Such third parties may be subject to various regulations and while we seek to ensure that the third party logistics providers comply with such provisions, any non-compliance by such logistics providers can expose us to the risk of confiscation of material, delayed deliveries, penalties and other adverse actions.

Further, we cannot assure you that we will be successful in continuing to receive uninterrupted, quality service from such third parties transporters on whom we rely for all of our current and future logistics requirements. Any disruption or inefficiencies in the operations of these third parties may adversely affect our business and results of operations.

**24. *Our inability to effectively manage our growth or to successfully implement our business plan and growth strategy could have an adverse effect on our business, results of operations, cash flows and financial condition.***

The success of our business will depend greatly on our ability to effectively implement our business and growth strategy. Our growth strategy involves increasing our share of business amongst existing customers, expanding to include new customers across the globe, and continuing focus on improving operational efficiencies among other strategies. For further details, see section titled “*Our Business – Strategies*” on page 114. Our success in implementing our growth strategies may be affected by changes in the industry we or our customers cater to and our ability to adapt to such changes, our ability to retain our customers and increase our share of business from such customers, expand into new customers. Many of these factors are beyond our control and there is no assurance that we will succeed in implementing our strategy.

Separately, as part of our growth strategy we intend to enter new geographies and evaluate technologies we are currently not present in.

There can be no assurance that we will be able to execute our strategy in a timely manner or at all and within our estimated budget, or that our expansion and development plans will increase our profitability. Moreover, the

growth strategies are based on management estimates which are based on certain assumptions, including our understanding of the market, which may not materialize. In the event such management estimates prove to be inaccurate, our business, financial conditions, cash flows and results of operations may be adversely affected.

**25. *We face competition from both domestic as well as international players and our inability to compete effectively may have a material adverse impact on our business and results of operations.***

Competition in our business is based on relationships with customers, product quality, pricing, infrastructure and customisation. We may face price pressures from our customers who aim to produce their products at competitive costs and consequently, source products manufactured by us at cheaper prices. We are unable to assure you that we shall be able to meet the pricing pressures imposed by such customers which would adversely affect our profitability. Additionally, some of our competitors may have greater financial, research and technological resources, larger sales and marketing teams and more established reputation. They may also be in a better position to identify market trends, adapt to changes in industry, innovate new products, offer competitive prices due to economies of scale and also ensure product quality and compliance, among others, which may adversely affect our business, cash flows and financial condition.

Accordingly, our ability to maintain and increase our revenue is significantly dependent on our relationships with our customers. If our competitors are able to offer better quality, delivery commitments, more competitive rates, and more favourable terms of sale to our existing customers, our business and revenues could be adversely affected.

**26. *Our Company will not receive any proceeds from the Offer for Sale portion. Objects of the Fresh Issue for which the funds are being raised have not been appraised by any bank or financial institution and any variation in the utilization of our Net Proceeds as disclosed in this Prospectus would be subject to certain compliance requirements, including prior shareholders' approval.***

The Offer includes an offer for sale of 7,500,000 Equity Shares by the Selling Shareholder. The proceeds from the Offer for Sale (net of expenses and taxes) will be paid to Selling Shareholder and we will not receive any such proceeds.

Our Company intends to primarily use the Net Proceeds of the Fresh Issue for our long term working capital requirements and general corporate purposes, as described in section "Objects of the Offer" on page 80.

The plans for utilizing the Net Proceeds of the Fresh Issue are based on management estimates and such intended use of proceeds has not been appraised by any bank or financial institution. The funding requirements are based on current conditions and are subject to change in response to external circumstances, costs, other financial condition or business strategies. Our Company may have to revise its management estimates from time to time and consequently its requirements may change, which may cause an additional burden on our finance plans, as a result of which, our business, financial condition, results of operations and cash flows could be materially and adversely impacted.

Any change in the Objects of the Fresh Issue would also require shareholders' approval and may involve considerable time or may not be forthcoming and in such an eventuality it may adversely affect our operations or business. Further, our Promoters or controlling shareholders would be required to provide an exit opportunity to the shareholders who dissent with our proposal to change the objects of the Offer, which may discourage our Promoters or our controlling shareholders from undertaking steps for the variation of the proposed utilisation of our Net Proceeds, even if such variation is in our interest.

In light of these factors, we may not be able to undertake any variation in Objects of the Fresh Issue to use any unutilized proceeds of the Fresh Issue even if such variation is in our interest, thereby limiting or delaying our efforts to use the Net Proceeds to achieve profitable growth in our business.

**27. *We do not hold any patents or other form of intellectual property protection in relation to our manufacturing processes, and our inability to maintain the integrity and secrecy of our manufacturing processes may adversely affect our business.***

While we possess technical knowledge about our products and design our tools in-house, our know-how may not be adequately protected by intellectual property rights. While we generally take precautions to protect our trade secrets and confidential information against breach of trust by our employees, consultants, job workers, customers and suppliers, it is possible that unauthorized disclosure of our trade secrets or confidential information may occur. We cannot assure you that we will be successful in the protection of our trade secrets and confidential information.

Our manufacturing processes may not be eligible for intellectual property protection and others may be able to use the same or similar production processes, thereby undermining any competitive advantage we may have derived from such processes and adversely affecting our financial condition, cash flows and results of operations.

**28. *Exchange rate fluctuations in various currencies in which we do business could negatively impact our business, financial condition, cash flows and results of operations.***

Although our reporting currency is in Indian Rupees, we transact a significant portion of our business in several other currencies, primarily US Dollars and Euro. For Fiscal 2021, 2020, and 2019, our revenue from operations from outside India as a percentage of revenue from operations were 56.12%, 53.82%, and 56.27%, respectively.

The exchange rate between the Rupee and foreign currencies has fluctuated significantly in the past and may continue to fluctuate in the future. Any significant appreciation of the Rupee (in case of exports) and depreciation of the Rupee (in case of imports) against foreign currencies in which we do business can fundamentally affect our competitiveness in the long-term. As our financial statements are presented in Indian Rupees, such fluctuations could have a material impact on our reported results. While imports offer us a partial hedge, we are still exposed to the fluctuation in currencies and for the Fiscal 2021 foreign exchange differences (net) included in other income and exchange difference regarded as an adjustment to borrowing costs included in finance costs amounted to ₹ 100.32 million which amounted to 1.63% of our revenues from operations. For Fiscal 2020, and 2019, foreign exchange differences (net) included in other income and exchange difference regarded as an adjustment to borrowing costs included in finance costs amounted to ₹ (0.23) million, and ₹ 49.36 million and constituted (0.01%), and 0.55% of our revenue from operations, respectively. Our inability to efficiently manage such currency risk in future may have an adverse effect on our results of operations, cash flows and financial condition.

**29. *Any downgrade in our credit ratings could increase our borrowing costs, affect our ability to obtain financing, and adversely affect our business, results of operations, cash flows and financial condition***

Our Company currently has a credit rating of CARE BB; Stable i.e. moderate risk of default regarding timely servicing of financial obligations issued by Care Ratings. During a period of July 2017 to June 2019, the Company's credit rating had been downgraded to CARE D (indicating default or expected to be in default soon) on account of ongoing delays in servicing of its debt obligations. Our credit ratings, which are intended to measure our ability to meet our debt obligations, are a significant factor in determining our finance costs. The interest rates of certain of our borrowings may be significantly dependent on our credit ratings. A downgrade of our credit ratings could lead to greater risk with respect to refinancing our debt and would likely increase our cost of borrowing and adversely affect our business, financial condition, cash flows, results of operations and prospects.

**30. *Our operations could be adversely affected by strikes, work stoppages or increased wage demands by our employees or any other kind of disputes with our employees and contract labour.***

As of June 30, 2021, we employed 1,815 employees. While we consider our current labour relations to be good, we cannot assure you that we will not experience disruptions in work due to disputes or other problems with our work force, which may adversely affect our ability to perform our obligations for the projects. Further, our employees are currently not part of any trade union. If our employees were unionized, there is no assurance that we will be able to negotiate a favourable wage settlement agreement.

In order to retain operational efficiencies, we engage independent contractors through whom we engage contract labour for performance of certain functions at our manufacturing units as well as at our offices. As on June 30, 2021, we engaged 654 contract labourers. Although we do not engage these labourers directly, we are responsible for any wage payments to be made to such labourers in the event of default by such independent contractors. Any requirement to fund their wage requirements may have an adverse impact on our results of operations, cash flows and our financial conditions.



Further, while we have not experienced significant labour unrest in the past, strikes, lock-outs and other labour action, may have an adverse impact on our operations, and if not resolved in a timely manner, could lead to disruptions in our operations. We cannot guarantee that we will not experience any strike, work stoppage or other industrial action in the future and any such event could adversely affect our business, results of operation, cash flows and financial condition. Additionally, our inability to engage adequate number of suppliers of contract labours, could have a material adverse effect on our business, cash flows, financial condition and profitability.

Further, new laws or regulations, changes (including increasing strictness) in the enforcement of existing laws or regulations, or any consequent penalties, applicable to us and our employees or our ability to comply with these laws or regulations may adversely affect our business. Any such changes, if implemented, could adversely affect our operating margins, manufacturing operations, cash flows and results of operations. We cannot assure you that we will be able to comply with such laws or regulations in the future.

**31. *We have in the past not complied with the corporate social responsibility requirements under the Companies Act, 2013***

Companies meeting certain financial thresholds are also required to constitute a committee of the board of directors for corporate social responsibility activities and ensure that at least 2% of the average profit before tax of the company during three immediately preceding financial years are utilized for corporate social responsibility activities. Penalties for instances of non-compliance have been prescribed under the Companies Act, 2013, which may result in inter alia, our Company, Directors and Key Managerial Personnel being subject to such penalties and formal actions as prescribed under the Companies Act, 2013. For instance, for Fiscal 2021, 2020 and 2019, 89.88%, 52.20% and 48.58% of the gross amount required to be spent by the Company during the year on corporate social responsibility related activities remained unutilized. We cannot assure you that no penalties will be imposed on us or our Directors and Key Managerial Personnel regarding such non-compliance in the future, the costs of which may be significant, and which may have an adverse impact on our business, financial condition and reputation.

**32. *Interest of our Promoters, Directors and key management persons, other than normal remuneration or benefits or reimbursement of expenses incurred.***

Our Promoters, certain Directors and certain key management persons are interested to the extent of their shareholding the Company and related party transactions. For further details see “*Our Management - Interest of Directors*”, see “*Our Management - Interest of KMP*”, “*Our Promoter and Promoter Group – Interests of Promoter in the promotion of our Company*”, and “*Summary of the Offer Document – Summary of Related Party Transactions*” on pages 141, 150, 153, and 18, respectively.

**33. *Our success depends on our ability to understand evolving industry trends and to fulfill the changing preferences of our customers.***

Our ability to anticipate changes in technology and regulatory standards on a timely basis will be a significant factor in our ability to remain competitive. We cannot assure you that we will be able to achieve the technological advances that may be necessary for us to remain competitive. Additionally, to compete effectively in the manufacturing and forging industry, we must be able to fulfil our customers’ changing preferences in a timely manner. Product or technology obsolescence may cause our offerings to lose their competitive edge. However, we cannot assure you that we will be able to understand the evolving industry trends, which could adversely affect our results of operations.

**34. *If we are unable to raise additional capital, our business prospects could be adversely affected.***

We intend to fund our future strategy through Net Proceeds, our internal accruals and borrowings from financial institutions. We will continue to incur expenditure in maintaining and growing the manufacturing infrastructure at our existing manufacturing facilities. We cannot assure you that we will have sufficient capital resources for our current operations or any future expansion plans that we may have. While we expect our internal accruals and cash flow from operations to be adequate to fund our existing commitments, our ability to incur any future borrowings is dependent upon the success of our operations. Additionally, the inability to obtain sufficient financing could adversely affect our ability to complete expansion plans. Our ability to arrange financing and the costs of capital of such financing are dependent on numerous factors, including general economic and capital

market conditions, credit availability from banks, investor confidence, the continued success of our operations and other laws that are conducive to our raising capital in this manner. If we decide to meet our capital requirements through debt financing, we may be subject to certain restrictive covenants. If we are unable to raise adequate capital in a timely manner and on favourable terms, or at all, our business, results of operations, cash flows and financial condition could be adversely affected.

**35. *Our ability to pay dividends in the future will depend on our earnings, financial condition, working capital requirements, capital expenditures and restrictive covenants of our financing arrangements.***

Our Company has not paid dividends in the last three financial years and our ability to pay dividends in the future will depend on our earnings, financial condition, cash flow, working capital requirements, capital expenditure and restrictive covenants of our financing arrangements including the CDR Package. Any future determination as to the declaration and payment of dividends will be at the discretion of our Board of Directors and will depend on factors that our Board deems relevant, including among others, our future earnings, financial condition, cash requirements, business prospects and any other financing arrangements. We cannot assure you that we will be able to pay dividends in the future. For further details, see section titled “*Dividend Policy*” on page 160.

**36. *Any failure of our information technology systems could adversely affect our business and our operations.***

We use information technology systems that support our business processes. These systems may be susceptible to outages due to fire, floods, power loss, telecommunications failures, natural disasters, break-ins and similar events. Effective response to such disruptions will require effort and diligence on the part of our employees to avoid any adverse effect to our information technology systems. For instance, any breakdown of our information technology systems could impair our ability to operate effectively. In addition, our systems and proprietary data stored electronically may be vulnerable to computer viruses, cybercrime, computer hacking and similar disruptions from unauthorized tampering. If such unauthorized use of our systems were to occur, data related to our product design, proprietary information of our customers available with us, product development and other proprietary information could be compromised. Further, any compromise of our information technology systems may cause similar or significantly more adverse disruptions in the systems of our customers. The occurrence of any of these events could adversely affect our business, interrupt our operations, subject us to increased operating costs and expose us to litigation.

**37. *We have in the past entered into related party transactions and may continue to do so in the future, which may potentially involve conflicts of interest with the equity shareholders.***

We have in the course of our business entered into, and will continue to enter into, several transactions with our related parties. For further details, see section titled “*Related Party Transactions*” on page 159. We cannot assure you that we will receive similar terms in our related party transactions in the future. We cannot assure you that we could not have achieved more favourable terms had such transactions been entered into with unrelated parties. Any further transactions we may enter into with our related parties could potentially involve conflicts of interest which may be detrimental to our Company. Further, the Companies Act, 2013 has brought into effect significant changes to the Indian company law framework including specific compliance requirements such as obtaining prior approval from the audit committee, board of directors and shareholders for certain related party transactions. We cannot assure you that such transactions in the future, individually or in the aggregate, will not have an adverse effect on business and financial results, including because of potential conflicts of interest or otherwise. For further details in relation to related party transactions, see section titled “*Related Party Transactions*” on page 159.

**38. *Our Promoter and members of our Promoter Group will continue to retain control over our Company after completion of the Issue, which will allow them to influence the outcome of matters submitted for approval of our shareholders.***

Following the completion of the Issue, our Promoter and members of our Promoter Group will continue to hold approximately 57.64% of our post-Offer Equity Share capital. As a result, they will have the ability to significantly influence matters requiring share-holders approval, including the ability to appoint Directors to our Board of Directors and the right to approve significant actions at Board and at shareholders’ meetings, including the issue of Equity Shares and dividend payments, business plans, mergers and acquisitions, any consolidation or joint venture arrangements, any amendment to our MOA and AOA, and any assignment or transfer of our interest

in any of our licenses. We cannot assure you that our promoters will not have conflicts of interest with other shareholders or with our Company. Any such conflict may adversely affect our ability to execute our business strategy or to operate our business.

**39. *We may be unable to enforce our rights under some of our agreements with counterparties on account of insufficient stamping and non-registration or other reasons.***

We enter into agreements with third parties, in relation to sale of goods, supply of raw materials and services, or acquisition of land among others. The terms, tenure and the nature of the agreements may vary depending on, amongst other things, the subject matter of the agreement and the third party involved. Some of the agreements executed by us may be inadequately stamped or not registered or may not otherwise be enforceable. Inadequately stamped documents may be impounded by the appropriate authority. Such inadequately stamped or not registered documents may not be admissible in evidence in a court of law until the applicable stamp duty, with penalty, has been paid and registered, which could, therefore, impact our ability to enforce our rights under the agreements in a timely manner or at all. In case, we are required to enforce such agreements, we will be required to adjudicate such inadequately stamped agreements in accordance with the applicable law of respective states, which may have impact on our financials.

**40. *We do not own all the premises from which we operate and continuous and uninterrupted use and possession of such premises are subject to certain conditions as per the lease agreements.***

Our windmills are situated at Bhogat and Lamba sites (Gujarat), which are on premises that have respectively been leased and sub-leased by us from third parties through lease or leave and license or tenancy arrangements. For further details, see “Our Business – Properties”. Upon expiration of the relevant agreement for each such premise, we will be required to negotiate the terms and conditions on which the lease agreement may be renewed. We cannot assure you that we will be able to renew these agreements on commercially reasonable terms in a timely manner, or at all.

Termination of our sub-lease may occur for reasons beyond our control, such as breaches of lease agreements by the landlords of our premises which is detrimental to our operations. If we, our current or future landlords breach the lease agreements, we may have to relocate to alternative premises or shut down our operations at that site.

In addition, we may not be able to assess or identify all risks and liabilities associated with any properties, such as faulty or disputed title, unregistered encumbrances or adverse possession rights, improperly executed, unregistered or insufficiently stamped instruments, or other defects that we may not be aware of. In the event that these existing sub-leases are terminated or they are not renewed on commercially acceptable terms or at all, we may suffer a disruption in our operations. If alternative premises are not available at the same or similar costs, size or locations, our business, financial condition, cash flows and results of operations may be adversely affected.

**41. *Statistical and industry data in this Prospectus may be inaccurate, incomplete or unreliable. Certain sections of this Prospectus disclose information from industry reports commissioned by us and any reliance on such information for making an investment decision in the Offer is subject to inherent risks***

We have not independently verified statistical, third party and industry data obtained from industry publications and other sources referred to in this Prospectus. This Prospectus includes information that is derived from the research report titled [*“Indian Bearings Industry – Industry revenue to witness a smart recovery in FY 2022”* dated March 2021, which was prepared by ICRA Limited, a research house, pursuant to an engagement with our Company on November 19, 2020 (**“ICRA Report”**)]. We commissioned and paid for the ICRA Report for the purpose of confirming our understanding of the bearing rings and auto-component industry in India. Neither we, nor any of the BRLMs, nor any other person connected with the Offer has verified the information in the ICRA Report. ICRA Limited has advised that while it has taken due care and caution in preparing the ICRA Report, which is based on information obtained from sources that it considers reliable (*“Information”*), it does not guarantee the accuracy, adequacy or completeness of the Information and disclaims responsibility for any errors or omissions in the Information or for the results obtained from the use of the Information. The ICRA Report also highlights certain industry and market data, which may be subject to assumptions. There are no standard data gathering methodologies in the industry in which we conduct our business, and methodologies and assumptions vary widely among different industry sources. Further, such assumptions may change based on various factors. We cannot assure you that ICRA Limited’s assumptions are correct or will not change and, accordingly, our

position in the market may differ from that presented in this Prospectus. Further, the ICRA Report is not a recommendation to invest or disinvest in our Company. ICRA Limited has disclaimed all financial liability towards the subscribers, users, transmitters or distributors of the commissioned report. Prospective investors are advised not to unduly rely on the ICRA Report or extracts thereof as included in this Prospectus when making their investment decisions.

**42. *Restated Financial Statements included in this Prospectus may not be comparable with the audited financial statements of the Company prepared in accordance with Ind AS.***

The Restated Financial Statements included in this Prospectus may vary from the audited financials for the respective years or periods.

The Company has prepared its first financial statements in accordance with Ind AS from the accounting year ending March 31, 2021, while the previous years' financial statements have been prepared as per IGAAP. As a result, our Restated Financial Statements included in this Prospectus may differ from such financial statements.

Further we cannot assure you that the comparative descriptions of Restated Financial Statements included in this Prospectus, including in the section "*Management's Discussion and Analysis of Financial Condition and Results of Operations*" beginning on page 224 provide any meaningful analysis for audited financials for the same periods.

On account of such differences, our investors will not have the benefit of considering comparable performance over prior periods and any reliance on our Restated Financial Statements or the audited financial statements for any of our prior periods should be accordingly limited.

**43. *The Selling Shareholder shall have a right to nominate a director on the Board post completion of the Issue.***

Post-completion of the Issue, the Selling Shareholder shall have the right to nominate a director to our Board. The exercise of this right by the Selling Shareholder, post the completion of Issue, is subject to confirmation by the Shareholders at the first general meeting held after the completion of the Issue. For further details, please see "*Main Provisions of Articles of Association*" on page 299.

All special rights available to the Investors, will cease to exist upon listing of Equity Shares on the Stock Exchanges pursuant to the Offer, (without requiring any further action) except for the rights subject to approval of the Shareholders by way of a special resolution, in a general meeting post listing of the Equity Shares.

**44. *Certain non-GAAP financial measures and certain other statistical information relating to our operations and financial performance like EBITDA have been included in this Prospectus. These non-GAAP financial measures are not measures of operating performance or liquidity defined by Ind AS and may not be comparable.***

Certain non-GAAP financial measures and certain other statistical information relating to our operations and financial performance like EBITDA, EBITDA margin, net worth, return on net worth, Net Asset Value per Equity Share and debt equity ratio, total borrowing to total equity have been included in this Prospectus. These non-GAAP Measures are not a measurement of our financial performance or liquidity under Ind AS, Indian GAAP, or IFRS and should not be considered in isolation or construed as an alternative to cash flows, profit/ (loss) for the year or any other measure of financial performance or as an indicator of our operating performance, liquidity, profitability or cash flows generated by operating, investing or financing activities derived in accordance with Ind AS, Indian GAAP, or IFRS. These non-GAAP financial measures and other statistical and other information relating to our operations and financial performance may not be computed on the basis of any standard methodology that is applicable across the industry and therefore may not be comparable to financial measures and statistical information of similar nomenclature that may be computed and presented by other companies and are not measures of operating performance or liquidity defined by Ind AS and may not be comparable to similarly titled measures presented by other companies.

**45. *Information relating to our installed capacities and the historical capacity utilization of our manufacturing facilities included in this Prospectus is based on various assumptions and estimates and future production and capacity utilization may vary.***

Information relating to our installed capacities and the historical capacity utilization of our manufacturing facilities included in this Prospectus is based on various assumptions and estimates of our management, including proposed operations, assumptions relating to availability and quality of raw materials and assumptions relating to potential utilization levels and operational efficiencies. Actual utilization rates may differ significantly from the estimated installed capacities or historical estimated capacity utilization information of our facilities. Undue reliance should therefore not be placed on our installed capacity or historical estimated capacity utilization information for our existing facilities included in this Prospectus.

## **EXTERNAL RISK FACTORS**

**1. *Unforeseeable business interruptions, including war, terrorist activities, political and social unrest, epidemics and natural disasters, such as earthquakes, could have a negative effect on the Indian economy and adversely affect our business.***

India has experienced natural calamities such as earthquakes, tsunamis, floods and drought in the past few years. The extent and severity of these natural disasters determines their effect on the Indian economy. In addition, India has witnessed local civil disturbances in recent years, in particular communal violence across ethnic or communal lines involving conflicts, riots and other forms of violence between communities of different religious faith or ethnic origins, and it is possible that future civil unrest as well as other adverse social, economic or political events in India could have an adverse effect on our business. Events such as these, terrorist attacks and other acts of violence or war may adversely affect the Indian securities markets. In addition, any deterioration in international relations, especially between India and its neighbouring countries, may result in investor concern regarding regional stability which could adversely affect the price of the Equity Shares. Such incidents could also create a greater perception that investment in Indian companies involves a higher degree of risk and could have an adverse effect on our business and the market price of the Equity Shares.

Other acts of violence or war outside India, including those involving the United States, the United Kingdom or other countries, may adversely affect worldwide financial markets and could adversely affect the world economic environment, which could adversely affect our business, results of operations, financial condition and cash flows, and more generally, any of these events could lower confidence in India. South Asia has, from time to time, experienced instances of civil unrest and hostilities among other neighbouring countries.

**2. *The Offer Price of the Equity Shares may not be indicative of the market price of the Equity Shares after the Offer.***

The Offer Price of the Equity Shares will be determined by our Company in consultation with the BRLMs and in accordance with the Book Building Process and will be based on numerous factors. For further information, see section titled “*Basis for Offer Price*” on page 87. The Offer Price may not be indicative of the market price for the Equity Shares after the Offer. The market price of the Equity Shares could be subject to significant fluctuations after the Offer, and may decline below the Offer Price. There can be no assurances that Bidders who are Allotted Equity Shares through the Offer will be able to resell their Equity Shares at or above the Offer Price.

**3. *Your percentage of ownership may be diluted in the future.***

We may be required to finance our growth through future equity offerings. Any future equity issuances by our Company, including a primary offering, may lead to the dilution of investors’ shareholdings in the Company. Any future issuances of Equity Shares or the disposal of Equity Shares by our Promoter or any of our other principal shareholders or the perception that such issuance or sales may occur, including to comply with the minimum public shareholding norms applicable to listed companies in India may adversely affect the trading price of the Equity Shares, which may lead to other adverse consequences including difficulty in raising capital through offering of the Equity Shares or incurring additional debt. Although our Promoter will be subject to a lock-in after the Offer, sales of a large number of our Equity Shares by our Promoter and significant shareholders after the expiry of the lock-in periods could adversely affect the market price of our Equity Shares. For further details on the lock-in of Equity Shares, see section titled “*Capital Structure*” on page 64.

There can be no assurance that we will not issue further Equity Shares or that the shareholders will not dispose of the Equity Shares. Any future issuances could also dilute the value of your investment in the Equity Shares. In addition, any perception by investors that such issuances or sales may occur may also affect the market price of the Equity Shares.

**4.  *Holders of Equity Shares may be restricted in their ability to exercise pre-emptive rights under Indian law and thereby suffer future dilution of their ownership position.***

Under the Companies Act, a company having share capital and incorporated in India must offer its holders of equity shares pre-emptive rights to subscribe and pay for a proportionate number of equity shares to maintain their existing ownership percentages before the issuance of any new equity shares, unless the pre-emptive rights have been waived by adoption of a special resolution by our Company. However, if the laws of the jurisdiction the investors are located in do not permit them to exercise their pre-emptive rights without our filing an offering document or registration statement with the applicable authority in such jurisdiction, the investors will be unable to exercise their pre-emptive rights unless our Company makes such a filing. If our Company elects not to file a registration statement, the new securities may be issued to a custodian, who may sell the securities for the investor's benefit. The value the custodian receives on the sale of such securities and the related transaction costs cannot be predicted. In addition, to the extent that the investors are unable to exercise preemptive rights granted in respect of the Equity Shares held by them, their proportional interest in our Company would be reduced.

**5.  *We will incur increased costs as a result of becoming a listed public company.***

As a listed public company, we will incur legal, accounting, insurance and other expenses that we have not incurred as a private company, including costs associated with public company reporting requirements. We expect that rules and regulations will increase our legal and financial compliance costs and make some activities more time-consuming and costly, although we are currently unable to estimate these costs with any degree of certainty. Laws and regulations could also make it more difficult or costly for us to obtain certain types of insurance, including director and officer liability insurance, and we may be forced to accept reduced policy limits and coverage or incur substantially higher costs to obtain the same or similar coverage. Laws and regulations could also make it more difficult for us to attract and retain qualified persons to serve on our board of directors, our board committees or as our senior management. Furthermore, if we are unable to satisfy our obligations as a public company, we could be subject to delisting, fines, sanctions and other regulatory action and potentially civil litigation.

**6.  *There is no existing market for our Equity Shares, and we do not know if one will develop. The price of our Equity Shares may be volatile, and you may be unable to resell your Equity Shares at or above the Offer Price, or at all.***

Prior to the Issue, there has been no public market for our Equity Shares, and an active trading market on the Indian Stock Exchanges may not develop or be sustained after the Issue. The Offer Price of the Equity Shares may bear no relationship to the market price of the Equity Shares after the Issue. We cannot assure you that the initial public offering price of the Equity Shares, or the market price following our initial public offering, will equal or exceed prices in privately negotiated transactions of our shares that may have occurred from time to time prior to our initial public offering. The market price of the Equity Shares after the Offer may be subject to significant fluctuations in response to, among other factors, variations in our operating results, market conditions and environment towards developments relating to India and volatility in the BSE and the NSE and securities markets elsewhere in the world. Any of these factors may result in large and sudden changes in the volume and trading price of the Equity Shares. In the past, following periods of volatility in the market price of a company's securities, shareholders have often instituted securities class action litigation against that company. If we were involved in a class action suit, it could divert the attention of management, and, if adversely determined, have a material adverse effect on our business, cash flows, results of operations and financial condition.

**7.  *Any downgrading of India's debt rating by an international rating agency could have an adverse impact on our business.***

India's sovereign debt rating could be downgraded due to various factors, including changes in tax or fiscal policy or decline in India's foreign exchange reserves, which are outside our control. Any adverse revision to the rating of India's domestic or international debt by international rating agencies may adversely impact our ability to raise

additional financing and the interest rates and other commercial terms at which such funding is available. This could have an adverse effect on our business and future financial performance, its ability to obtain financing for capital expenditures and the trading price of the Equity Shares.

**8. *Significant differences exist between Indian GAAP and other accounting principles, such as IFRS, which may be material to investors' assessments of our financial condition.***

Our audited financial statements as at and for the fiscal ended March 31, 2021 have been prepared in accordance with Ind AS and audited financial statements as at for the fiscal ended March 31, 2020, and March 31, 2019 have been prepared in accordance with Indian GAAP. We have not attempted to quantify the impact of US GAAP or IFRS on the financial data included in this Prospectus, nor do we provide a reconciliation of our financial statements to those of US GAAP or IFRS. US GAAP and IFRS differ in significant respects from Ind AS. Accordingly, the degree to which the financial statements included in this Prospectus will provide meaningful information is entirely dependent on the reader's level of familiarity with Indian accounting practices. Any reliance by persons not familiar with Indian accounting practices on the financial disclosures presented in this Prospectus should accordingly be limited. In addition, some of our competitors may not present their financial statements in accordance with Ind AS and their financial statements may not be directly comparable to ours, and therefore reliance should accordingly be limited.

**9. *Volatility in political, economic and social developments in India could adversely affect our business.***

The central and state governments serve multiple roles in the Indian economy, including producers, consumers and regulators, which may have a significant influence on us. Economic liberalization policies have encouraged private investment in our industry and changes in these governmental policies could have a significant impact on the business and economic conditions in India, which in turn could adversely affect our business, future financial condition and results of operations. In addition, the leadership of India has undergone multiple changes since 1996. Any political instability in India may adversely affect the Indian securities markets in general, which could also adversely affect the trading price of our Equity Shares.

**10. *Our business is dependent on the Indian economy.***

The performance and growth of our business are necessarily dependent on economic conditions prevalent in India, which may be materially and adversely affected by political instability or regional conflicts, a general rise in interest rates, inflation, and economic slowdown elsewhere in the world or otherwise.

There have been periods of slowdown in the economic growth of India. India's economic growth is affected by various factors including domestic consumption and savings, balance of trade movements, namely export demand and movements in key imports, global economic uncertainty and liquidity crisis, volatility in exchange currency rates and annual rainfall which affects agricultural production. Any continued or future slowdown in the Indian economy or a further increase in inflation could have a material adverse effect on the price of our raw materials and demand for our products and, as a result, on our business and financial results.

The Indian financial market and the Indian economy are influenced by economic and market conditions in other countries, particularly in emerging market in Asian countries. Financial turmoil in Asia, Europe, the U.S. and elsewhere in the world in recent years has affected the Indian economy. Although economic conditions are different in each country, investors' reactions to developments in one country can have adverse effects on the securities of companies in other countries, including India. A loss in investor confidence in the financial systems of other emerging markets may cause increased volatility in Indian financial markets and, indirectly, in the Indian economy in general. Any worldwide financial instability, could also have a negative impact on the Indian economy.

**11. *We may be adversely affected by future regulatory changes.***

The regulatory and policy environment in which we operate is evolving and subject to change. Such changes may adversely affect our business, financial condition, cash flows, results of operations and prospects, to the extent that we are unable to suitably respond to and comply with any such changes in applicable law and policy. Any significant changes in laws, regulations and rules, including relevant environment, fire laws, trade laws, licensing and permit requirements relating to our manufacturing units and operations might materially impact our

Company's operations and financials. For details, see "Key Regulations and Policies" on page 126. We are also subject to corporate, taxation and other laws in effect in India, which require continued monitoring and compliance. These laws and regulations and the way in which they are implemented and enforced may change, and could result in us being deemed to be in contravention of such laws and may require us to apply for additional approvals. There can be no assurance that future legislative or regulatory changes will not have any adverse effect on our business, results of operations, cash flows, and financial condition.

**12. *Foreign investors are subject to foreign investment restrictions under Indian law that limits our ability to attract foreign investors, which may adversely impact the market price of the Equity Shares.***

Under foreign exchange regulations currently in force in India, transfer of shares between non-residents and residents are freely permitted (subject to certain restrictions), if they comply with the pricing guidelines and reporting requirements specified by the RBI. If the transfer of shares, which are sought to be transferred, is not in compliance with such pricing guidelines or reporting requirements or falls under any of the exceptions referred to above, then a prior regulatory approval will be required. Furthermore, in accordance with the FDI Policy, read along with the press note 3 of 2020, dated April 17, 2020, issued by the Department for Promotion of Industry and Internal Trade, Government of India, the FDI Policy has been recently amended to state that all foreign direct investments by entities incorporated in a country which shares land border with India or where the beneficial owner of an investment into India is situated in or is a citizen of any such country will require prior approval of the Government of India and shall have to be in conformity with the applicable provisions of the FEMA. Additionally, shareholders who seek to convert Rupee proceeds from a sale of shares in India into foreign currency and repatriate that foreign currency from India require a no-objection or a tax clearance certificate from the Indian income tax authorities. Further, this conversion is subject to the equity shares having been held on a repatriation basis and, either the security having been sold in compliance with the pricing guidelines or, the relevant regulatory approval having been obtained for the sale of equity shares and corresponding remittance of the sale proceeds. Further, in accordance with the FEMA Non-debt Instruments Rules and the FDI Policy, investments where the beneficial owner of the equity shares is situated in or is a citizen of a country which shares land border with India, can only be made through the Government approval route. We cannot assure investors that any required approval from the RBI or any other governmental agency can be obtained on any particular terms or at all. For further information, see "*Restrictions on Foreign Ownership of Indian Securities*" on page 298. Our ability to raise any foreign capital under the FDI route is therefore constrained by Indian law, which may adversely affect our business, financial condition, cash flows, results of operations and prospects.

**13. *Financial instability in Indian financial markets could adversely affect our results of operations, cash flows and financial condition.***

The Indian financial market and the Indian economy are influenced by economic and market conditions in other countries, particularly in Asian emerging market countries. Financial turmoil in global economy in recent years has affected the Indian economy. Although economic conditions are different in each country, investors' reactions to developments in one country can have adverse effects on the securities of companies in other countries, including India. A loss in investor confidence in the financial systems of other emerging markets may cause increased volatility in Indian financial markets and, indirectly, in the Indian economy in general. Any worldwide financial instability could also have a negative impact on the Indian economy. Financial disruptions may occur again and could harm our results of operations, cash flows and financial condition.

**14. *Civil disturbances, regional conflicts and other acts of violence in India and abroad may disrupt or otherwise adversely affect the Indian economy.***

Certain events that are beyond the control of our Company, such as violence or war, including those involving India, the United Kingdom, the United States, members of the European Union or other countries, may adversely affect worldwide financial markets and could potentially lead to a severe economic recession, which could adversely affect our business, results of operations, financial condition and cash flows, and more generally, any of these events could lower confidence in India's economy. Southern Asia has, from time to time, experienced instances of civil unrest and political tensions and hostilities among neighbouring countries. Political tensions could create a perception that there is a risk of disruption of services provided by India-based companies, which could have an adverse effect on our business, future financial performance and price of the Equity Shares. Furthermore, if India were to be engaged in armed hostilities, particularly hostilities that are protracted or involve the threat or use of nuclear weapons, the Indian economy and consequently Company's operations might be



significantly affected. India has from time to time experienced social and civil unrest and hostilities, including riots, regional conflicts and other acts of violence. Events of this nature in the future could have an adverse effect on our ability to develop our business. As a result, our business, results of operations, cash flows and financial condition may be adversely affected.

**15. *Economic developments and volatility in securities markets in other countries may cause the price of our Equity Shares to decline.***

The Indian economy and its securities markets are influenced by economic developments and volatility in securities markets in other countries. Investors' reactions to developments in one country may have adverse effects on the market price of securities of companies located in other countries, including India. Any worldwide financial instability could also have a negative impact on the Indian economy, including the movement of exchange rates and interest rates in India. Negative economic developments, such as rising fiscal or trade deficits, or a default on sovereign debt, in other emerging market countries may affect investor confidence and cause increased volatility in Indian securities markets and indirectly affect the Indian economy in general.

**16. *You may be subject to Indian taxes arising out of capital gains on the sale of our Equity Shares.***

Under current Indian tax laws, unless specifically exempted, capital gains arising from the sale of equity shares in an Indian company are generally taxable in India. Previously, any gain realised on the sale of listed equity shares on or before March 31, 2018 on a stock exchange held for more than 12 months was not subject to long-term capital gains tax in India if Securities Transaction Tax ("STT") was paid on the sale transaction and, additionally, as stipulated by the Finance Act, 2017, STT, had been paid at the time of acquisition of such equity shares on or after October 1, 2004, except in the case of such acquisitions of Equity Shares which are not subject to STT, as notified by the Central Government on June 5, 2017. However, the Finance Act, 2018, has introduced taxation on such long-term capital gains exceeding ₹100,000 arising from sale of equity shares on or after April 1, 2018, while continuing to exempt the unrealised capital gains earned up to January 31, 2018 on such Equity Shares. Accordingly, you may be subject to payment of long-term capital gains tax in India, in addition to payment of STT, on the sale of any Equity Shares held for more than 12 months. STT will be levied on and collected by a domestic stock exchange on which the Equity Shares are sold.

Further, any gain realised on the sale of listed equity shares held for a period of 12 months or less will be subject to short-term capital gains tax in India. Capital gains arising from the sale of the Equity Shares will be exempt from taxation in India in cases where the exemption from taxation in India is provided under a treaty between India and the country of which the seller is resident. Generally, Indian tax treaties do not limit India's ability to impose tax on capital gains. As a result, residents of other countries may be liable for tax in India as well as in their own jurisdiction on a gain upon the sale of the Equity Shares.

**17. *Rights of shareholders under Indian laws may be more limited than under the laws of other jurisdictions.***

Our Articles of Association, composition of our Board, Indian laws governing our corporate affairs, the validity of corporate procedures, directors' fiduciary duties, responsibilities and liabilities, and shareholders' rights may differ from those that would apply to a company in another jurisdiction. Shareholders' rights under Indian law may not be as extensive and wide-spread as shareholders' rights under the laws of other countries or jurisdictions. Investors may face challenges in asserting their rights as shareholder in an Indian company than as a shareholder of an entity in another jurisdiction.

**18. *QIBs and Non-Institutional Investors are not permitted to withdraw or lower their Bids (in terms of quantity of Equity Shares or the Bid Amount) at any stage after submitting a Bid.***

Pursuant to the SEBI ICDR Regulations, QIBs and Non-Institutional Investors are not permitted to withdraw or lower their Bids (in terms of quantity of Equity Shares or the Bid Amount) at any stage after submitting a Bid. Retail Individual Investors can revise their Bids during the Bid/Offer Period and withdraw their Bids until Bid/Offer Closing Date. While our Company is required to complete Allotment pursuant to the Offer within six Working Days from the Bid/ Offer Closing Date, events affecting the Bidders' decision to invest in the Equity Shares, including material adverse changes in international or national monetary policy, financial, political or economic conditions, our business, results of operation, cash flows or financial condition may arise between the

date of submission of the Bid and Allotment. Our Company may complete the Allotment of the Equity Shares even if such events occur, and such events may limit the Bidders' ability to sell the Equity Shares Allotted pursuant to the Offer or may cause the trading price of the Equity Shares to decline on listing.

**19. *We may be affected by competition law in India and any adverse application or interpretation of the Competition Act could in turn adversely affect our business.***

The Competition Act, 2002, as amended (the "**Competition Act**"), regulates practices having an appreciable adverse effect on competition in the relevant market in India. Under the Competition Act, any formal or informal arrangement, understanding or action in concert, which causes or is likely to cause an appreciable adverse effect on competition is considered void and may result in the imposition of substantial monetary penalties. Further, any agreement among competitors which directly or indirectly involves the determination of purchase or sale prices, limits or controls production, supply, markets, technical development, investment or provision of services, shares the market or source of production or provision of services in any manner by way of allocation of geographical area, type of goods or services or number of customers in the relevant market or in any other similar way or directly or indirectly results in bid-rigging or collusive bidding is presumed to have an appreciable adverse effect on competition. The Competition Act also prohibits abuse of a dominant position by any enterprise. If it is proved that the contravention committed by a company took place with the consent or connivance or is attributable to any neglect on the part of, any director, manager, secretary or other officer of such company, that person shall be also guilty of the contravention and may be punished.

On March 4, 2011, the GoI issued and brought into force the combination regulation (merger control) provisions under the Competition Act with effect from June 1, 2011. These provisions require acquisitions of shares, voting rights, assets or control or mergers or amalgamations that cross the prescribed asset and turnover based thresholds to be mandatorily notified to and pre-approved by the Competition Commission of India (the "**CCI**"). Additionally, on May 11, 2011, the CCI issued the Competition Commission of India (Procedure in regard to the transaction of business relating to combinations) Regulations, 2011, as amended, which sets out the mechanism for implementation of the merger control regime in India. The Competition Act aims to, among other things, prohibit all agreements and transactions, which may have an appreciable adverse effect on competition in India. Further, the CCI has extraterritorial powers and can investigate any agreements, abusive conduct or combination occurring outside India if such agreement, conduct or combination has an appreciable adverse effect on competition in India.

The applicability or interpretation of the Competition Act to any merger, amalgamation or acquisition proposed or undertaken by us, or any enforcement proceedings initiated by CCI for alleged violation of provisions of the Competition Act may adversely affect our business, cash flows, financial condition or results of operation. We cannot assure you that we will be able to obtain approval for any future acquisitions on satisfactory terms, or at all. If we are affected directly or indirectly by the application or interpretation of any provision of the Competition Act or any proceedings initiated by the CCI or any other relevant authority (or any other claim by any other party under the Competition Act) or any adverse publicity that may be generated due to scrutiny or prosecution under the Competition Act, including by way of financial penalties, our reputation may also be materially and adversely affected.

**20. *Investors may not be able to enforce a judgment of a foreign court against us or our management.***

We are incorporated under the laws of India and certain of our Directors and executive officers reside in India. Furthermore, all of our Company's assets are located in India. As a result, you may be unable to:

- effect service of process in jurisdictions outside India, including in the United States, upon our Company; or
- enforce in Indian courts judgments obtained in courts of jurisdictions outside India against our Company, including judgments predicated upon the civil liability provisions of the securities laws of jurisdictions outside India.

Recognition and enforcement of foreign judgments is provided for under Section 13 and Section 44A of the Code of Civil Procedure, 1908. India has reciprocal recognition and enforcement of judgments in civil and commercial matters with only a limited number of jurisdictions, such as the United Kingdom, Singapore and Hong Kong. In order to be enforceable, a judgment from a jurisdiction with reciprocity must meet certain requirements of the

Indian Code of Civil Procedure, 1908 (“CPC”). The CPC only permits the enforcement and execution of monetary decrees in the reciprocating jurisdiction, not being in the nature of any amounts payable in respect of taxes, other charges, fines or penalties. Judgments or decrees from jurisdictions which do not have reciprocal recognition with India cannot be enforced by proceedings in execution in India. Therefore, a final judgment for the payment of money rendered by any court in a non-reciprocating territory for civil liability, whether or not predicated solely upon the general laws of the non-reciprocating territory, would not be enforceable in India.

The party in whose favour a final foreign judgment in a non-reciprocating territory is rendered may bring a fresh suit in a competent court in India based on the final judgment within three years of obtaining such final judgment. However, it is unlikely that a court in India would award damages on the same basis as a foreign court if an action were brought in India or that an Indian court would enforce foreign judgments if it viewed the amount of damages as excessive or inconsistent with Indian public policy.

**21. *Once the Equity Shares are listed on the Stock Exchanges, there is no assurance that the Equity Shares will remain listed.***

Although we currently intended that the Equity Shares will remain listed on the Stock Exchanges once they are listed, there is no guarantee of the continued listing of the Equity Shares. Among other factors, we may not continue to satisfy the listing requirements of the Stock Exchanges. Accordingly, Shareholders will not be able to sell their Equity Shares through trading on the Stock Exchanges if the Equity Shares are no longer listed on the Stock Exchanges.

### **SECTION III – INTRODUCTION**

#### **SUMMARY FINANCIAL INFORMATION**

The following tables set forth summary financial information derived from our Restated Financial Statements as of and for the Fiscal Years ended March 31, 2019 (proforma), March 31, 2020, and March 31, 2021.

The summary financial information presented below should be read in conjunction with “*Financial Statements*” and “*Management’s Discussion and Analysis of Financial Condition and Results of Operations*” beginning on pages 161 and 224, respectively.

***[Remainder of this page intentionally kept blank]***

## Summary Statement of Assets and Liabilities

(₹ in million)

Particulars	As at March 31, 2021	As at March 31, 2020	As at March 31, 2019 (Proforma)
<b>Assets</b>			
<b>Non-current assets</b>			
Property, plant, and equipment	3,713.93	3,730.30	3,808.40
Capital work in progress	11.52	-	9.52
Right-of-use assets	0.50	0.66	0.82
Intangible assets	9.48	11.70	14.14
Financial assets			
a) Loans	-	25.00	33.30
b) Other financial assets	139.63	33.70	125.00
Income tax assets (net)	19.66	19.50	19.66
Other non-current assets	288.23	111.29	131.41
	<b>4,182.95</b>	<b>3,932.15</b>	<b>4,142.25</b>
<b>Current assets</b>			
Inventories	1,710.73	1,305.71	1,602.01
Financial assets			
a) Loans	0.76	30.87	1.23
b) Trade receivables	1,708.01	1,276.72	1,814.96
c) Cash and cash equivalents	46.12	12.45	1.38
d) Bank balances other than Cash and cash equivalents	58.05	151.91	45.25
e) Other financial assets	67.96	59.99	102.00
Other current assets	194.66	91.93	113.49
	<b>3,786.29</b>	<b>2,929.58</b>	<b>3,680.32</b>
<b>Total assets</b>	<b>7,969.24</b>	<b>6,861.73</b>	<b>7,822.57</b>
<b>Equity and liabilities</b>			
<b>Equity</b>			
Equity share capital	239.81	239.81	239.81
Other equity	3,327.52	2,441.24	1,913.63
<b>Total equity</b>	<b>3,567.33</b>	<b>2,681.05</b>	<b>2,153.44</b>
<b>Liabilities</b>			
<b>Non-current liabilities</b>			
Financial liabilities			
a) Borrowings	323.45	442.43	913.40
b) Lease liabilities	0.67	0.94	1.18
Income tax liabilities (net)	179.31	179.31	170.53
Deferred tax liabilities (net)	324.06	569.45	506.17
Provisions	31.09	30.89	23.40
	<b>858.58</b>	<b>1,223.02</b>	<b>1,614.68</b>
<b>Current liabilities</b>			
Financial Liabilities			
a) Borrowings	1,835.72	1,939.26	2,343.25
b) Lease liabilities	0.39	0.39	0.39
c) Trade payables			
- total outstanding dues of micro and small enterprises	19.20	14.76	25.43
- total outstanding dues of creditors other than micro and small enterprises	1,157.15	723.71	887.56
d) Other financial liabilities	433.97	261.22	671.18
Other liabilities	14.75	8.43	13.23
Provisions	7.27	7.19	6.52
Income tax liabilities (net)	74.88	2.70	106.89
	<b>3,543.33</b>	<b>2,957.66</b>	<b>4,054.45</b>
<b>Total liabilities</b>	<b>4,401.91</b>	<b>4,180.68</b>	<b>5,669.13</b>
<b>Total equity and liabilities</b>	<b>7,969.24</b>	<b>6,861.73</b>	<b>7,822.57</b>

## Summary Statement of Profit and Loss

(₹ in million unless otherwise stated)

Particulars	Year ended March 31, 2021	Year ended March 31, 2020	Year ended March 31, 2019 (Proforma)
<b>Income</b>			
Revenue from operations	6,163.32	6,659.94	9,043.23
Other income	34.25	93.38	69.31
<b>Total income (I)</b>	<b>6,197.57</b>	<b>6,753.32</b>	<b>9,112.54</b>
<b>Expenses</b>			
Cost of raw materials and components consumed	3,165.94	3,137.41	4,529.36
Decrease/ (increase) in inventories of finished goods and work-in progress	(291.60)	155.92	(190.06)
Employee benefits expense	518.66	526.59	608.06
Finance costs	116.99	321.69	420.19
Depreciation and amortization expense	254.09	265.24	254.40
Other expenses	1,681.64	1,625.64	2,084.99
<b>Total expenses (II)</b>	<b>5,445.72</b>	<b>6,032.49</b>	<b>7,706.94</b>
<b>Restated profit before tax (III) = (I - II)</b>	<b>751.85</b>	<b>720.83</b>	<b>1,405.60</b>
<b>Tax expense</b>			
Current tax expenses	130.42	127.17	308.90
Deferred tax charge / (Credit)	(248.12)	64.25	506.29
<b>Total tax expense (IV)</b>	<b>(117.70)</b>	<b>191.42</b>	<b>815.19</b>
<b>Restated profit for the year (V) = (III - IV)</b>	<b>869.55</b>	<b>529.41</b>	<b>590.41</b>
<b>Other comprehensive income (OCI)</b>			
<b>Items not to be reclassified to profit or loss in subsequent years :</b>			
Re-measurement gains/ (losses) on defined benefit plans	7.81	(2.77)	(0.35)
Less: Income tax relating to these items	(2.73)	0.97	0.12
<b>Restated total other comprehensive income for the year, net of tax (VI)</b>	<b>5.08</b>	<b>(1.80)</b>	<b>(0.23)</b>
<b>Restated total comprehensive income for the year, net of tax (VII)=(V-VI)</b>	<b>874.63</b>	<b>527.61</b>	<b>590.18</b>
<b>Restated Earnings per equity share (face value ₹10)</b> <i>Computed on the basis of restated profit for the year (In ₹)</i>			
- Basic	36.26	22.08	24.62
- Diluted	35.96	22.08	24.62

## Summary Statement of Cash Flows

(₹ in million)

Particulars	Year ended March 31, 2021	Year ended March 31, 2020	Year ended March 31, 2019 (Proforma)
<b>A. Cash flow from operating activities</b>			
<b>Restated profit before tax</b>	<b>751.85</b>	<b>720.83</b>	<b>1,405.60</b>
<b>Adjustment to reconcile restated profit before tax to net cash flows</b>			
Depreciation and amortisation expense	254.09	265.24	254.40
Provision for impairment of financial assets (net)	-	-	3.33
Gain/(loss) on sale of Property, Plant & Equipment (net)	(0.72)	0.45	(4.27)
Finance cost	116.99	321.69	420.19
Unrealised (gain)/loss on foreign exchange (net)	(29.82)	13.30	(24.91)
Interest income	(14.74)	(14.75)	(14.55)
<b>Operating profit before working capital changes</b>	<b>1,077.65</b>	<b>1,306.76</b>	<b>2,039.79</b>
<b>Working capital adjustments</b>			
Increase/ (decrease) in trade payables	447.96	(184.01)	(58.33)
Increase in other financial liabilities, other liabilities and provisions	22.49	1.16	8.20
(Increase)/ decrease in trade receivables	(417.85)	611.18	168.60
(Increase)/ decrease in inventories	(405.01)	296.29	6.67
(Increase)/ decrease in loans, other financial assets, and other assets	(74.70)	28.82	121.99
Cash generated from operations	650.54	2,060.20	2,286.92
Direct taxes paid (net of refunds)	(58.40)	(222.43)	(348.87)
<b>Net cash flows from operating activities (A)</b>	<b>592.14</b>	<b>1,837.77</b>	<b>1,938.05</b>
<b>B. Cash flows from investing activities</b>			
Purchase of property, plant and equipment and intangible assets (including capital advances) and Capital Work in Progress	(387.29)	(160.94)	(367.41)
Proceeds from sale of property, plant and equipment	2.43	3.80	4.57
Investment in margin money deposits	(103.06)	(106.66)	(135.94)
Redemption of margin money deposits having original maturity more than 12 months	93.86	91.03	135.96
Inter corporate deposit (given to) / received from related party	25.00	8.30	(8.30)
Interest received	5.98	22.77	7.63
<b>Net cash flows (used in) investing activities (B)</b>	<b>(363.08)</b>	<b>(141.70)</b>	<b>(363.49)</b>
<b>C. Net cash flow from financing activities</b>			
Repayment of short-term borrowings (net)	(97.24)	(480.72)	(257.68)
Repayment of long-term borrowings	(223.54)	(866.68)	(909.72)
Proceeds from long-term borrowings	208.10	-	-
Proceeds from issue of Optionally Convertible Redeemable Preference Shares	26.30	-	-

<b>Particulars</b>	<b>Year ended March 31, 2021</b>	<b>Year ended March 31, 2020</b>	<b>Year ended March 31, 2019 (Proforma)</b>
Payment of principal portion of lease liabilities	(0.39)	(0.39)	(0.39)
Interest paid	(108.62)	(337.21)	(412.33)
<b>Net cash flows (used in) financing activities (C)</b>	<b>(195.39)</b>	<b>(1,685.00)</b>	<b>(1,580.12)</b>
<b>Net (decrease)/ increase in cash and cash equivalents (A + B + C)</b>	<b>33.67</b>	<b>11.07</b>	<b>(5.56)</b>
Cash and cash equivalents at the beginning of the year	12.45	1.38	6.94
<b>Cash and cash equivalents at the end of the year</b>	<b>46.12</b>	<b>12.45</b>	<b>1.38</b>
<b>Components of cash and cash equivalents</b>			
Cash on hand	0.42	0.35	0.45
Balances with banks			
- on current accounts	45.70	12.10	0.93
		-	-
<b>Total cash and cash equivalents</b>	<b>46.12</b>	<b>12.45</b>	<b>1.38</b>



## THE OFFER

The following table summarises the Offer details:

Offer of Equity Shares	8,122,222 Equity Shares aggregating to ₹ 7,310 million
<i>Of which:</i>	
Fresh Issue <sup>(1)</sup>	622,222 Equity Shares aggregating to ₹ 560 million
Offer for Sale <sup>(2)</sup> by Selling Shareholder (i.e. Rivendell PE LLC)	7,500,000 Equity Shares aggregating up to ₹ 6,750 million
<i>The Offer consists of:</i>	
<b>A. QIB Portion</b> <sup>(3) (4)</sup>	Not more than 4,061,110 Equity Shares
<i>Of</i>	<i>which:</i>
Anchor Investor Portion	2,436,666 Equity Shares
Net QIB Portion (assuming Anchor Investor Portion is fully subscribed)	1,624,444 Equity Shares
<i>Of which:</i>	
Mutual Fund Portion (5% of the Net QIB Portion)	81,223 Equity Shares
Balance of QIB Portion for all QIBs including Mutual Funds	1,543,221 Equity Shares
<b>B. Non-Institutional Portion</b> <sup>(4)</sup>	Not less than 1,218,334 Equity Shares
<b>C. Retail Portion</b> <sup>(4)</sup>	Not less than 2,842,778 Equity Shares
<b>Pre and post-Offer Equity Shares</b>	
Equity Shares outstanding prior to the Offer	26,611,090 Equity Shares
Equity Shares outstanding after the Offer	27,233,312 Equity Shares
<b>Use of Net Proceeds of this Offer</b>	See “ <i>Objects of the Offer</i> ” on page 80 for information about the use of the proceeds from the Fresh Issue. Our Company will not receive any proceeds from the Offer for Sale.

<sup>(1)</sup> Our Board has authorised the Fresh Issue, pursuant to its resolution dated March 12, 2021 read with its resolution July 18, 2021. Our Shareholders have authorised the Fresh Issue pursuant to their resolution dated March 12, 2021.

<sup>(2)</sup> The Offer for Sale of 7,500,000 Equity Shares has been authorised by the Selling Shareholder (i.e. Rivendell PE LLC) through a resolution of its board of directors dated July 17, 2021 read with its consent letter dated July 17, 2021. The Selling Shareholder (i.e. Rivendell PE LLC) confirms that the Offered Shares have been held by it for a period of at least one year prior to the date of filing of this Prospectus, and are accordingly eligible for being offered for sale in the Offer as required by the SEBI ICDR Regulations. For more details, see “*Capital Structure*” beginning on page 64.

<sup>(3)</sup> Our Company and Selling Shareholder (i.e. Rivendell PE LLC), in consultation with the BRLMs, allocated 60% of the QIB Portion to Anchor Investors on a discretionary basis in accordance with the SEBI ICDR Regulations. One-third of the Anchor Investor Portion was reserved for domestic Mutual Funds, subject to valid Bids being received from domestic Mutual Funds at or above the Anchor Investor Allocation Price. 5% of the QIB Portion (excluding the Anchor Investor Portion) was available for allocation on a proportionate basis to Mutual Funds only, and the remainder of the QIB Portion (excluding the Anchor Investor Portion) was available for allocation on a proportionate basis to all QIB Bidders (other than Anchor Investors), including Mutual Funds, subject to valid bids being received at or above the Offer Price. For further details, see “*Offer Procedure*” on page 280.

<sup>(4)</sup> Subject to valid Bids being received at or above the Offer Price, under-subscription, if any, in any category, except in the QIB Portion, is allowed to be met with spill over from any other category or combination of categories at the discretion of our Company, in consultation with the BRLMs and the Designated Stock Exchange. In the event of under-subscription in the Offer, subject to receiving minimum subscription for 90% of the Fresh Issue and compliance with Rule 19(2)(b) of the Securities Contracts (Regulation) Rules, 1957, the Allotment for the valid Bids will be made in the first instance towards subscription for 90% of the Fresh Issue. For further details, see, “*Terms of the Offer*” on page 272.

Allocation to Bidders in all categories, except the Retail Portion and Anchor Investor Portion, if any, was made on a proportionate basis, subject to valid Bids received at or above the Offer Price. The Allocation to each Retail

Individual Bidder was not less than the minimum Bid lot, subject to availability of Equity Shares in Retail Portion, and the remaining available Equity Shares, if any, were made available for allocation on a proportionate basis. For further details, see “*Offer Procedure*” beginning on page 280.

## GENERAL INFORMATION

Our Company is presently known as ‘Rolex Rings Limited’. Our Registered Office is located behind Glowtech Steel Private Limited, Gondal Road, Kotharia, Rajkot – 360004, Gujarat. Our Corporate Office is located Near Kotharia Railway Crossing, opposite Hotel Krishna Park, Gondal Road, Kotharia, Rajkot, Gujarat 360 004. The company registration number of our Company is 041991 and our CIN is U28910GJ2003PLC041991. Our Company is registered with the Registrar of Companies, Gujarat, Dadra and Nagar Haveli, located at Ahmedabad.

For details of changes in the name and registered office address of our Company, see ‘*History and Certain Corporate Matters*’ on page 131.

### Address of the Registrar of Companies

Our Company is registered with the Registrar of Companies, Gujarat, Dadra and Nagar Haveli, situated at the following address:

#### Registrar of Companies

ROC Bhavan , Opp Rupal Park Society,  
Behind Ankur Bus Stop,  
Naranpura, Ahmedabad 380013

### Board of Directors

The table below sets forth the details of the constitution of our Board:

Name	Designation	DIN	Address
Manesh Dayashankar Madeka	Chairman and Managing Director	01629788	Maya, Parnakuti Society Street Number 5, Plot number 61, Nana Mava Road, Rajkot, Gujarat, 360 001
Bhautik Dayashankar Madeka	Whole Time Director	01761543	27, Trisha Bungalow, Near Chandan Super Market, Amin Marg, Rajkot, Gujarat, 360001
Mihir Rupeshkumar Madeka	Whole Time Director	01778561	Daya Parnakuti Society, Street No. 3, Plot No. 11, Nana Mava Road, Rajkot, Gujarat, 360001
Vivek Sett	Nominee Director	00031084	1001 Marathon Heights, P. B. Marg, Worli, Mumbai, Maharashtra, 400 013
Pravinchandra Ratilal Dholakia	Independent Director	00844014	Pooja Adarsh Society 3/5, Race Course Ring, Behind I.O.C Bhavan, Rajkot, Gujarat 360001
Dipesh Dhirajlal Kundaliya	Independent Director	08035547	Amijyot, 9/14 Sardar Nagar, Sardar Nagar Main Road, Near Jain Upasara, Rajkot, Gujarat 360001
Jignasa Pravinchandra Mehta	Independent Director	08035567	M-193, Gujarat Housing Board, behind Jankalyan Community Hall, Amin Marg, Rajkot, Gujarat 360001
Ashit Ravishankar Vankani	Independent Director	08988523	Suraj Apartment-02, Flat No – 51/A, Shroff Road, Rajkot, Gujarat 360001

For brief profiles of our Directors, please see “*Our Management*” on page 136.

### Selling Shareholder

The selling shareholder in the Offer is Rivendell PE LLC.

### Company Secretary and Compliance Officer for the Offer

Hardik Dhimantbhai Gandhi is the Company Secretary and Compliance Officer of our Company. His contact details are as follows:

B/h. Glowtech Steel Private Limited,  
Gondal Road, Kotharia,  
Rajkot – 360004, Gujarat

**Tel:** 0281 6699677/577  
**E-mail:** compliance@rolexrings.com

### **Statutory Auditors of our Company**

#### **S R B C & Co LLP**

21<sup>st</sup> Floor, B Wing, Privilon Building  
Ambli BRT Road, Behind Iskcon Temple,  
Ahmedabad – 380 059

**Tel.:** +91 79 6608 3900

**E-mail:** srbc.co@srb.in

**ICAI Firm Registration Number:**324982E/E300003

**Peer Review Number:** 012054

### **Changes in Statutory Auditors**

There has been no change in the Statutory Auditors during the three years immediately preceding the date of this Prospectus.

### **Book Running Lead Managers**

#### **Equirus Capital Private Limited**

12<sup>th</sup> Floor, C Wing, Marathon Futurex,  
N M Joshi Marg, Lower Parel,  
Mumbai 400 013

**Tel:** +91 22 4332 0700

**E-mail:** rolexrings.ipo@equirus.com

#### **Investor Grievance E-mail:**

investorsgrievance@equirus.com

**Website:** www.equirus.com

**Contact Person:** Ankesh Jain

**SEBI Registration No.:** INM000011286

#### **IDBI Capital Markets & Securities Limited**

6<sup>th</sup> Floor, IDBI Tower,  
WTC Complex, Cuffe Parade,  
Mumbai 400 005

**Tel:** +91 22 2217 1700

**E-mail:** rolex.ipo@idbicapital.com

#### **Investor Grievance E-mail:**

redressal@idbicapital.com

**Website:** www.idbicapital.com

**Contact Person:** Indrajit Bhagat/ Vaibhav Shah

**SEBI Registration No.:** INM000010866

#### **JM Financial Limited**

7th Floor, Cnergy,  
Appasaheb Marathe Marg,  
Prabhadevi, Mumbai 400 025

**Tel.:** +91 22 6630 3030

**E-mail:** rolexrings@jmfl.com

**Investor grievance e-mail:** grievance.ibd@jmfl.com

**Website:** www.jmfl.com

**Contact Person:** Prachee Dhuri

**SEBI Registration:** INM000010361

### **Statement of inter-se allocation of responsibilities among the BRLMs**

The responsibilities and coordination by the BRLMs for various activities in this Offer are as follows:

<b>Sr. No.</b>	<b>Activity</b>	<b>Responsibility</b>	<b>Co-ordinator</b>
1.	Capital structuring, positioning strategy and due diligence of the Company including its operations/management/business plans/legal etc. Drafting and design of the Draft Red Herring Prospectus, Red Herring Prospectus, Prospectus, abridged prospectus and application form. The BRLMs shall ensure compliance with stipulated requirements and completion of prescribed formalities with the Stock Exchanges, RoC and SEBI including finalization of Prospectus and RoC filing.	Equirus, JM Financial and IDBI	Equirus
2.	Drafting and approval of all statutory advertisements	Equirus, JM Financial and IDBI	Equirus

<b>Sr. No.</b>	<b>Activity</b>	<b>Responsibility</b>	<b>Co-ordinator</b>
3.	Appointment of intermediaries viz., Registrar, Printers, Advertising Agency, Syndicate, Sponsor Bank, Bankers to the Offer and other intermediaries, including coordination of all agreements to be entered into with such intermediaries	Equirus, JM Financial and IDBI	Equirus
4.	Drafting and approval of all publicity material other than statutory advertisement as mentioned in (2) above including corporate advertisement, brochure and filing of media compliance report.	Equirus, JM Financial and IDBI	JM Financial
5.	International Institutional marketing of the Offer, which will cover, inter alia: <ul style="list-style-type: none"> <li>• Institutional marketing strategy;</li> <li>• Finalizing the list and division of international investors for one-to-one meetings;</li> <li>• Finalizing international road show and investor meeting schedule</li> </ul>	Equirus, JM Financial and IDBI	JM Financial
6.	Domestic Institutional marketing of the Offer, which will cover, inter alia: <ul style="list-style-type: none"> <li>• Preparation of road show marketing presentation and frequently asked questions;</li> <li>• Institutional marketing strategy;</li> <li>• Finalizing the list and division of domestic investors for one-to-one meetings; and</li> <li>• Finalizing domestic road show and investor meeting schedule</li> </ul>	Equirus, JM Financial and IDBI	Equirus
7.	Non-Institutional marketing of the Offer and retail marketing of the Issue, which will cover, inter alia: <ul style="list-style-type: none"> <li>• Formulating marketing strategies;</li> <li>• preparation of publicity budget, finalizing media and public relations strategy.</li> <li>• Finalizing centres for holding conferences for brokers</li> <li>• Finalizing collection centres;</li> <li>• Arranging for selection of underwriters and underwriting agreement and</li> <li>• Follow-up on distribution of publicity and Issue material including form, prospectus and deciding on the quantum of the Offer material.</li> </ul>	Equirus, JM Financial and IDBI	JM Financial
8.	Managing the book and finalization of pricing in consultation with the Company and the Selling Shareholders.	Equirus, JM Financial and IDBI	IDBI
9.	Coordination with Stock Exchanges for Book Building Process, filing of letters including software, bidding terminals, mock trading, payment of 1% security deposit to the Designated Stock Exchange and Anchor Investor intimation	Equirus, JM Financial and IDBI	IDBI
10.	Post- Issue activities, which shall involve essential follow-up with bankers to the Offer and SCSBs to get quick estimates of collection and advising our Company about the closure of the Issue, based on correct figures, finalization of the basis of allotment or weeding out of multiple applications, listing of instruments, demat credit and refunds, payment of STT on behalf of the Selling Shareholders and coordination with various agencies connected with the post-Issue activity such as Registrar to the Issue, Bankers to the Issue, SCSBs including responsibility for underwriting arrangements, as applicable. Co-ordination with SEBI and Stock Exchanges for refund of 1% security deposit and submission of all post Issue reports including the initial and final post Issue report to SEBI	Equirus, JM Financial and IDBI	JM Financial

## **Registrar to the Offer**

### **Link Intime India Private Limited**

C 101, 247 Park, L. B. S. Marg

Vikhroli (West)

Mumbai 400 083

**Tel:** +91 22 4918 6200

**E-mail:** rolex.ipo@linkintime.co.in

**Investor grievance e-mail:** rolex.ipo@linkintime.co.in

**Website:** www.linkintime.co.in

**Contact person:** Shanti Gopalkrishnan

**SEBI Registration No.:** INR000004058

## **Legal Counsel to the Offer as to Indian Law**

### **IndusLaw**

#1502B, 15<sup>th</sup> Floor, Tower – 1C,

“One World Centre”, Senapati Bapat Marg,

Lower Parel, Mumbai – 400 013

**Tel:** +91 22 4920 7200

## **Special International Legal Counsel to the BRLMs**

### **Duane Morris & Selvam LLP**

16 Collyer Quay, #17-00

Singapore 049318

**Tel:** +65 6311 0030

## **Bankers to our Company**

### **Bank of Baroda**

c/o Bank of Baroda,

Rajkot Main Branch,

Rajkot

**Tel.:** +91 281 2227816

**E-mail:** rajkot@bankofbaroda.co.in

**Website:** www.bankofbaroda.com

**Contact Person:** S S Iyer

### **Punjab National Bank**

c/o Punjab National Bank (E- OBC),

AUM Planet, Ground Floor,

Opposite Nirmala Convent School, Rajkot

**Tel:** +91 281 2573500

**E-mail:** bm0556@obc.co.in

**Website:** www.punjabnationalbank.com

**Contact Person:** Ganesh Pawar

### **Indian Overseas Bank**

BSNL CTO Building,

Opp. Jubilee, Jawahar Road,

Rajkot

**Tel:** +91 8141277881

**E-mail:** iob0144@iob.in

**Website:** www.iob.in

**Contact Person:** Rahul Singh

### **Bank of India**

Bank of India, Rajkot Main Branch,

BOI Building, Para Bazar,

Rajkot 360 001

**Tel:** +91 281 2238362

**E-mail:** rajkot.rajkot@bankofindia.co.in

**Website:** www.bankofindia.co.in

**Contact Person:** S K Punjabi

### **IDBI Bank Limited**

Specialised Corporate Branch,

2<sup>nd</sup> Floor, The Emporia Building,

Near Neel Da Dhaba, Kalawad Road,

Rajkot 360 005

**Tel:** +91 9724392980

**E-mail:** deepak.d@idbi.co.in

**Website:** www.idbibank.in

**Contact Person:** Deepak

### **Union Bank of India**

Nijanad Building, Dhebar Road,

Rajkot

**Tel:** +91 281 2233921

**E-mail:** cb19@corpbank.co.in

**Website:** www.unionbankofindia.co.in

**Contact Person:** Amitabh Asthana

## Syndicate Members

### **Equirus Securities Private Limited**

A2102 B, 21st Floor, A Wing,  
Marathon Futurex, N.M. Joshi Marg,  
Lower Parel Mumbai, 400 013  
Maharashtra, India  
Tel: 079 61909561  
Email: [jay.soni@equirus.com](mailto:jay.soni@equirus.com) / [admin\\_equities@equirus.com](mailto:admin_equities@equirus.com)  
Website: [www.equirus.com](http://www.equirus.com)  
Contact Person: Jay Soni  
SEBI Registration No: INZ000251536

### **JM Financial Services Limited**

Ground Floor, 2,3 & 4, Kamanwala Chmbers,  
Sir P.M. Road, Fort,  
Mumbai, Maharashtra 400 001  
Tel: +91 22 6136 3400  
E-mail: [surajit.misra@jmfl.com](mailto:surajit.misra@jmfl.com) / [deepak.vaidya@jmfl.com](mailto:deepak.vaidya@jmfl.com) / [tn.kumar@jmfl.com](mailto:tn.kumar@jmfl.com) / [sona.verghese@jmfl.com](mailto:sona.verghese@jmfl.com)  
Website: [www.jmflfinancialservices.in](http://www.jmflfinancialservices.in)  
Contact Person: Surajit Misra/Deepak Vaidya/Sona Verghese  
SEBI Registration No.: INZ000195834

## Escrow Collection Bank(s)/ Refund Bank(s)/Public Issue Account Bank/ Sponsor Banks

### **ICICI Bank Limited**

Capital Market Division, 1<sup>st</sup> floor,  
122, Mistry Bhavan, Dinshaw Vachha Road,  
Backbay Reclamation, Churchgate,  
Mumbai – 400 020  
Tel: 022 66818911/23/24  
Email: [kmr.saurabh@icicibank.com](mailto:kmr.saurabh@icicibank.com)  
Website: [www.icicibank.com](http://www.icicibank.com)  
SEBI Reg. No.: INBI00000004  
Contact Person: Saurabh Kumar

## Designated Intermediaries

### *Self Certified Syndicate Banks*

The list of SCSBs notified by SEBI for the ASBA process is available at <http://www.sebi.gov.in/sebiweb/other/OtherAction.do?doRecognised=yes>, or at such other website as may be prescribed by SEBI from time to time. A list of the Designated SCSB Branches with which an ASBA Bidder (other than a RII using the UPI Mechanism), not bidding through Syndicate/Sub Syndicate or through a Registered Broker, RTA or CDP may submit the Bid cum Application Forms, is available at <https://www.sebi.gov.in/sebiweb/other/OtherAction.do?doRecognisedFpi=yes&intmId=34>, or at such other websites as may be prescribed by SEBI from time to time.

### *SCSBs eligible as Issuer Banks for UPI Mechanism*

In accordance with SEBI Circular No. SEBI/HO/CFD/DIL2/CIR/P/2019/76 dated June 28, 2019 and SEBI Circular No. SEBI/HO/CFD/DIL2/CIR/P/2019/85 dated July 26, 2019, Retail Individual Investors using the UPI Mechanism may only apply through the SCSBs and mobile applications using the UPI handles specified on the website of the SEBI (<https://www.sebi.gov.in/sebiweb/other/OtherAction.do?doRecognisedFpi=yes&intmId=40>) and updated from time to time.

### *Syndicate SCSB Branches*

In relation to Bids (other than Bids by Anchor Investors and RIIs) submitted to a member of the Syndicate, the list of branches of the SCSBs at the Specified Locations named by the respective SCSBs to receive deposits of Bid cum Application Forms from the members of the Syndicate is available on the website of the SEBI at <http://www.sebi.gov.in/sebiweb/other/OtherAction.do?doRecognised=yes&intmId=35>, which may be updated from time to time or any such other website as may be prescribed by SEBI from time to time. For more information on such branches collecting Bid cum Application Forms from the Syndicate at Specified Locations, see the website of the SEBI at <http://www.sebi.gov.in/sebiweb/other/OtherAction.do?doRecognised=yes&intmId=35> or any such other website as may be prescribed by SEBI from time to time.

### *Registered Brokers*

The list of the Registered Brokers, including details such as postal address, telephone number, and e - mail address, is provided on the websites of BSE and NSE at [http://www.bseindia.com/Markets/PublicIssues/brokercentres\\_new.aspx?expandable=3](http://www.bseindia.com/Markets/PublicIssues/brokercentres_new.aspx?expandable=3) and [http://www.nseindia.com/products/content/equities/ipos/ipo\\_mem\\_terminal.htm](http://www.nseindia.com/products/content/equities/ipos/ipo_mem_terminal.htm), respectively, or such other websites as updated from time to time.

### *Registrar and Share Transfer Agents*

The list of the RTAs eligible to accept ASBA Forms at the Designated RTA Locations, including details such as address, telephone number, and e-mail address, are provided on the websites of BSE and NSE at <http://www.bseindia.com/Static/Markets/PublicIssues/RtaDp.aspx?expandable=6> and [http://www.nseindia.com/products/content/equities/ipos/asba\\_procedures.htm](http://www.nseindia.com/products/content/equities/ipos/asba_procedures.htm), respectively, or such other websites as updated from time to time.

### *Collecting Depository Participants*

The list of the CDPs eligible to accept ASBA Forms at the Designated CDP Locations, including details such as name and contact details, are provided on the websites of BSE and NSE at <http://www.bseindia.com/Static/Markets/PublicIssues/RtaDp.aspx?expandable=6> and [http://www.nseindia.com/products/content/equities/ipos/asba\\_procedures.htm](http://www.nseindia.com/products/content/equities/ipos/asba_procedures.htm), respectively, or such other websites as updated from time to time.

### **Credit Rating**

As this is an offer of Equity Shares, there is no credit rating for the Offer.

### **Grading of the Offer**

No credit agency registered with SEBI has been appointed in respect of obtaining grading for the Offer.

### **Debenture Trustees**

As this is an offer of Equity Shares, there are no debenture trustees appointed for the Offer.

### **Monitoring Agency**

In accordance with the proviso to Regulation 41(1) of the SEBI ICDR Regulations, no monitoring agency will be appointed for the Offer.

### **Appraising Entity**

None of the objects for which the Net Proceeds will be utilised have been appraised by any agency. Accordingly, no appraising entity is appointed for the Offer.

### **Filing**

A copy of the Draft Red Herring Prospectus has been filed through the SEBI Intermediary Portal at <https://sipotal.sebi.gov.in>, in accordance with SEBI circular bearing reference SEBI/HO/CFD/DIL1/CIR/P/2018/011 dated January 19, 2018 and at [cfddil@sebi.gov.in](mailto:cfddil@sebi.gov.in), in accordance with the instructions issued by the SEBI on March 27, 2020, in relation to “*Easing of Operational Procedure – Division of Issues and Listing – CFD*”.

A copy of the Red Herring Prospectus, along with the material contracts and documents required to be filed, has been delivered for filing to the RoC in accordance with Section 32 of the Companies Act, 2013, and a copy of this Prospectus is filed under Section 26 of the Companies Act, 2013 with the RoC at its office, and through the electronic portal at <http://www.mca.gov.in/mcafoportal/loginvalidateuser.do>.



## **Book Building Process**

“Book building” refers to the process of collection of Bids from investors on the basis of this Prospectus, the Bid cum Application Forms and the Revision Forms within the Price Band. The Price Band and minimum Bid Lot will be decided by our Company and the Selling Shareholder (i.e. Rivendell PE LLC) in consultation with the BRLMs, and advertised in all editions of the English national daily newspaper the Financial Express, all editions of the Hindi national daily newspaper Jansatta, and Rajkot edition of the Gujarati daily newspaper Jaihind (Gujarati being the regional language of Gujarat wherein our Registered Office is located), each with wide circulation, respectively, at least two Working Days prior to the Bid/ Offer Opening Date and shall be made available to the Stock Exchanges for the purpose of uploading on their website. The Offer Price shall be determined by our Company and the Selling Shareholder (i.e. Rivendell PE LLC) in consultation with the BRLMs, after the Bid/ Offer Closing Date.

**All Bidders, other than Anchor Investors and Retail Individual Investors, shall participate in the Offer mandatorily through the ASBA process by providing the details of their respective bank accounts in which the corresponding Bid Amount will be blocked by the SCSBs and Sponsor Bank, as the case may be. Anchor Investors are not permitted to participate in the Offer through the ASBA process. Retail Individual Investors may participate through the ASBA process by either (a) providing the details of their respective ASBA Account in which the corresponding Bid Amount will be blocked by the SCSBs or, (b) through the UPI Mechanism.**

**In accordance with the SEBI ICDR Regulations, QIBs Bidding in the Net QIB Portion and Non-Institutional Bidders bidding in the Non-Institutional Portion are not allowed to withdraw or lower the size of their Bid(s) (in terms of the quantity of the Equity Shares or the Bid Amount) at any stage. Retail Individual Investors (subject to the Bid Amount being up to ₹ 200,000) can revise their Bids during the Bid/ Offer Period and withdraw their Bids until the Bid/ Offer Closing Date. Anchor Investors cannot withdraw their Bids after the Anchor Investor Bidding Date. Further, allocation to QIBs in the Net QIB Portion will be on a proportionate basis and allocation to Anchor Investors in the Anchor Investor Portion will be on a discretionary basis.**

For further details, see “*Offer Structure*” and “*Offer Procedure*” on pages 277 and 280 respectively.

Our Company will comply with the SEBI ICDR Regulations and any other directions issued by SEBI in relation to this Offer. The Selling Shareholder (i.e. Rivendell PE LLC) has specifically confirmed that it will comply with the SEBI ICDR Regulations and any other directions issued by SEBI, as applicable to the Selling Shareholder (i.e. Rivendell PE LLC), in relation to the Offered Shares. In this regard, our Company and the Selling Shareholder (i.e. Rivendell PE LLC) have appointed the BRLMs to manage this Offer and procure Bids for this Offer.

**The Book Building Process is in accordance with guidelines, rules, regulations prescribed by SEBI. Bidders are advised to make their own judgment about an investment through this process prior to submitting a Bid.**

Bidders should note the Offer is also subject to obtaining (i) the final listing and trading approvals of the Stock Exchanges, which our Company shall apply for after Allotment; and (ii) the final approval of the RoC after the Prospectus is registered with the RoC.

## **Illustration of Book Building Process and the Price Discovery Process**

For an illustration of the Book Building Process and the price discovery process, see “*Offer Procedure*” on page 280.

## Underwriting Agreement

After the determination of the Offer Price, but prior to the filing of this Prospectus with the RoC, the Selling Shareholder (i.e. Rivendell PE LLC) and our Company intend to enter into the Underwriting Agreement with the Underwriters for the Equity Shares. It is proposed that pursuant to the terms of the Underwriting Agreement, each of the BRLMs shall be severally responsible for bringing in the amount devolved in the event the respective Syndicate Member do not fulfill their underwriting obligations. Pursuant to the terms of the Underwriting Agreement, the obligations of each of the Underwriters are several and are subject to certain conditions specified therein.

The Underwriting Agreement is dated August 3, 2021. The Underwriters have indicated their intention to underwrite the following number of Equity Shares:

Name, address, Tel. number and email address of the Underwriters	Indicative Number of Equity Shares to be underwritten	Amount underwritten (₹ million)
<b>Equirus Capital Private Limited</b> 12th Floor, C Wing, Marathon Futurex, N M Joshi Marg, Lower Parel, Mumbai 400013 Tel: +91 22 43320731 Email: rolexrings.ipo@equirus.com	2,707,308	2,436.58
<b>Equirus Securities Private Limited</b> A2102 B, 21st Floor, A Wing, Marathon Futurex, N.M. Joshi Marg, Lower Parel Mumbai, 400 013 Tel: +91 79 61909561 Email: jay.soni@equirus.com / admin_equities@equirus.com	100	0.09
<b>IDBI Capital Markets &amp; Securities Limited</b> 6th Floor, IDBI Tower, WTC Complex, Cuffe Parade, Mumbai 400005 Tel: +91 22 22171700 Email: zurich@idbicapital.com	2,707,407	2,436.67
<b>JM Financial Limited</b> 7th Floor, Cnergy, Appasaheb Marathe Marg Prabhadevi, Mumbai 400025 Tel: +91 22 6630 3548/ 90044 76922 Email: gitesh.vargantwar@jmfl.com	2,707,307	2,436.57
<b>JM Financial Services Limited</b> Ground Floor, 2, 3 & 4, Kamanwala Chmbers, Sir P.M. Road, Fort, Mumbai, Maharashtra 400001 Tel: +91 22 6136 3400 Email: surajit.misra@jmfl.com/deepak.vaidya@jmfl.com/ tn.kumar@jmfl.com/sona.verghese@jmfl.com	100	0.09
<b>Total</b>	<b>8,122,222</b>	<b>7310.00</b>

*The above-mentioned amount is indicative and will be finalised after determination of the Offer Price and finalisation of the Basis of Allotment and subject to the provisions of the SEBI ICDR Regulations.*

In the opinion of our Board (based on representations given by the Underwriters), the resources of the Underwriters are sufficient to enable them to discharge their respective underwriting obligations in full. The Underwriters are registered with SEBI under Section 12(1) of the SEBI Act or are registered as brokers with the Stock Exchange(s). The Board of Directors/ IPO Committee, at its meeting, held on August 3, 2021, has accepted and entered into the Underwriting Agreement mentioned above on behalf of our Company.

Allocation among the Underwriters may not necessarily be in the proportion of their underwriting commitments set forth in the table above. Notwithstanding the above table, each of the Underwriters shall be severally responsible for ensuring payment with respect to the Equity Shares allocated to Bidders procured by them, in accordance with the Underwriting Agreement.

In the event of any default in payment, the respective Underwriter, in addition to other obligations defined in the Underwriting Agreement, will also be required to procure subscribers for or subscribe to the Equity Shares to the extent of the defaulted amount in accordance with the Underwriting Agreement.

## CAPITAL STRUCTURE

The share capital of our Company, as of the date of this Prospectus, is set forth below.

*(In ₹, except share data)*

Sr. No.	Particulars	Aggregate nominal value	Aggregate value at offer price
<b>(A)</b>	<b>AUTHORISED SHARE CAPITAL</b>		
	56,000,000 shares	560,000,000	-
	<i>Comprising:</i>		
	35,025,000 Equity Shares of face value of ₹10 each	350,250,000	-
	5,000,000 OCRPS of face value of ₹10 each	50,000,000	
	15,975,000 NCRPS of face value of ₹10 each	159,750,000	
<b>(B)</b>	<b>ISSUED, SUBSCRIBED AND PAID-UP SHARE CAPITAL BEFORE THE OFFER</b>		
	40,216,953 shares	402,169,530	-
	<i>Comprising:</i>		
	2,66,11,090 Equity Shares of face value of ₹ 10 each	266,110,900	-
	13,605,863 NCRPS of face value of ₹ 10 each	136,058,630	
<b>(C)</b>	<b>PRESENT OFFER</b>		
	Offer of 8,122,222 Equity Shares <sup>(a)</sup>	81,222,220	7,309,999,800
	<i>Comprising:</i>		
	Fresh Issue of 622,222 Equity Shares, aggregating to ₹ 560.00 million	6,222,220	559,999,800
	Offer for Sale of 7,500,000 Equity Shares by the Selling Shareholder (i.e. Rivendell PE LLC), aggregating up to ₹ 6,750 million <sup>(b)</sup>	75,000,000	6,750,000,000
<b>(D)</b>	<b>ISSUED, SUBSCRIBED AND PAID-UP SHARE CAPITAL AFTER THE OFFER<sup>+</sup></b>		
	40,839,175 shares		
	<i>Comprising:</i>		
	27,233,312 Equity Shares of face value of ₹ 10 each	272,333,120	-
	13,605,863 NCRPS of face value of ₹ 10 each	136,058,630	
<b>(E)</b>	<b>SECURITIES PREMIUM ACCOUNT</b>		
	Before the Offer		1,626,141,684
	After the Offer		2,179,919,264

<sup>+</sup> Assuming full subscription in the Offer.

- (a) Our Board has authorised the Offer, pursuant to their resolution dated March 12, 2021 read with its resolution dated July 18, 2021. Our Shareholders have authorised the Offer pursuant to special resolution dated March 12, 2021.
- (b) The Selling Shareholder (i.e. Rivendell PE LLC) confirms that the Offered Shares has been held by it for a period of at least one year prior to the date of the Draft Red Herring Prospectus with SEBI in accordance with Regulation 8 of the SEBI ICDR Regulations and accordingly, are eligible for being offered for sale in the Offer in accordance with the provisions of the SEBI ICDR Regulations. The Selling Shareholder (i.e. Rivendell PE LLC) has confirmed and authorized its participation in the Offer for Sale. For details on the authorization by the Selling Shareholder (i.e. Rivendell PE LLC) in relation to the Offered Shares, see “The Offer” on page 54.

### Changes in our Authorised Share Capital

For details in relation to the changes in the authorised share capital of our Company, see “History and Certain Corporate Matters - Amendments to our Memorandum of Association” on page 131.

### Notes to Capital Structure

#### 1. Share Capital History

##### A. History of Equity Share capital of our Company

The following table sets forth the history of the Equity Share capital of our Company:

Date of allotment	Number of Equity Shares allotted	Face value (₹)	Offer price per Equity Share (₹)	Nature of consideration	Nature of allotment	Cumulative number of Equity Shares	Cumulative paid-up Equity Share Capital (₹)
February 13, 2003	100	100,000	100,000	Pursuant to conversion of partnership firm to joint stock company	Subscription to MOA <sup>(1)</sup>	100	10,000,000
March 31, 2003	1,100	100,000	100,000	Cash	Further Issue <sup>(2)</sup>	1,200	120,000,000
Pursuant to the ordinary resolution passed by shareholders dated August 22, 2007, our Company sub-divided the face value of its Equity Shares from ₹ 100,000 each to ₹ 10 each, and accordingly, 1,200 issued Equity Shares of our Company of ₹ 100,000 each were sub-divided into 12,000,000 Equity Shares of our Company of ₹ 10 each.							
April 26, 2010	9,975,000	10	150.65	Cash	Conversion of CCPS <sup>(3)</sup>	21,975,000	219,750,000
June 21, 2010	48,450	10	10	Cash	Rights Issue <sup>(4)</sup>	22,023,450	220,234,500
August 10, 2010	734,115	10	140	Cash	Rights Issue <sup>(5)</sup>	22,757,565	227,575,650
October 12, 2010	734,115	10	140	Cash	Rights Issue <sup>(6)</sup>	23,491,680	23,491,6800
December 2, 2010	489,410	10	140	Cash	Rights Issue <sup>(7)</sup>	23,981,090	239,810,900
July 16, 2021	2,630,000	10	10	Cash	Conversion of OCRPS <sup>(8)</sup>	26,611,090	266,110,900

<sup>(1)</sup> Subscription to MOA by Rupesh Dayashankar Madeka (14 Equity Shares), Jiten Dayashankar Madeka (17 Equity Shares), Manesh Dayashankar Madeka (15 Equity Shares), Ashok Dayashankar Madeka (15 Equity Shares), Pinakin Dayashankar Madeka (17 Equity Shares), Bhautik Dayashankar Madeka (10 Equity Shares), Paresh Dayashankar Madeka (3 Equity Shares), Mihir Rupeshkumar Madeka (3 Equity Shares), Hemal Paresh Madeka (3 Equity Shares) and Sanjay Bhagwanji Bole (3 Equity Shares) pursuant to conversion of a partnership firm, into a joint stock company under Part IX of the Companies Act, 1956. These Equity Shares were issued in proportion to the respective share held by each of the partners in the capital account of the partnership firm.

<sup>(2)</sup> Allotment of 1,100 Equity Shares to 10 allottees, i.e., Rupesh Dayashankar Madeka (154 Equity Shares), Jiten Dayashankar Madeka (187 Equity Shares), Manesh Dayashankar Madeka (165 Equity Shares), Ashok Dayashankar Madeka (165 Equity Shares), Pinakin Dayashankar Madeka (187 Equity Shares), Bhautik Dayashankar Madeka (110 Equity Shares), Paresh Dayashankar Madeka (33 Equity Shares), Mihir Rupeshkumar Madeka (33 Equity Shares), Hemal Paresh Madeka (33 Equity Shares) and Sanjay Bhagwanji Bole (33 Equity Shares).

<sup>(3)</sup> Allotment of 9,975,000 Equity Shares to one allottee i.e. Rivendell PE LLC pursuant to conversion of CCPS.

<sup>(4)</sup> Rights issue of 48,450 Equity Shares, in the ratio of one Equity Share for every 200 Equity Shares held, to one allottee, i.e., Rivendell PE LLC.

<sup>(5)</sup> Rights issue of 734,115 Equity Shares, in the ratio of one Equity Share for every 30 Equity Shares held, to 12 allottees, i.e., Rivendell PE LLC (334,115 Equity Shares), Rupesh Dayashankar Madeka (64,000 Equity Shares), Jiten Dayashankar Madeka (64,000 Equity Shares), Manesh Dayashankar Madeka (64,000 Equity Shares), Ashok Dayashankar Madeka (40,000 Equity Shares), Pinakin Dayashankar Madeka (68,000 Equity Shares), Bhautik Dayashankar Madeka (44,000 Equity Shares), Paresh Dayashankar Madeka (8,000 Equity Shares), Mihir Rupeshkumar Madeka (12,000 Equity Shares), Hemal Paresh Madeka (12,000 Equity Shares), Bharat Jiten Madeka (12,000 Equity Shares) and Sanjay Bhagwanji Bole (12,000 Equity Shares).

<sup>(6)</sup> Rights issue of 734,115 Equity Shares, in the ratio of one Equity Share for every 31 Equity Shares held, to 12 allottees, i.e., Rivendell PE LLC (334,115 Equity Shares), Rupesh Dayashankar Madeka (64,000 Equity Shares), Jiten Dayashankar Madeka (64,000 Equity Shares), Manesh Dayashankar Madeka (64,000 Equity Shares), Ashok Dayashankar Madeka (40,000 Equity Shares), Pinakin Dayashankar Madeka (68,000 Equity Shares), Bhautik Dayashankar Madeka (44,000 Equity Shares), Paresh Dayashankar Madeka (8,000 Equity Shares), Mihir Rupeshkumar Madeka (12,000 Equity Shares), Hemal Paresh Madeka (12,000 Equity Shares), Bharat Jiten Madeka (12,000 Equity Shares) and Sanjay Bhagwanji Bole (12,000 Equity Shares).

<sup>(7)</sup> Rights issue of 489,410 Equity Shares, in the ratio of one Equity Share for every 48 Equity Shares held, to 12 allottees, i.e., Rivendell PE LLC (222,743 Equity Shares), Rupesh Dayashankar Madeka (42,667 Equity Shares), Jiten Dayashankar Madeka (42,667 Equity Shares), Manesh Dayashankar Madeka (42,667 Equity Shares), Ashok Dayashankar Madeka (26,667 Equity Shares), Pinakin Dayashankar Madeka (45,333 Equity Shares), Bhautik

Dayashankar Madeka (29,333 Equity Shares), Paresh Dayashankar Madeka (5,333 Equity Shares), Mihir Rupeshkumar Madeka (8,000 Equity Shares), Hemal Paresh Madeka (8,000 Equity Shares), Bharat Jiten Madeka (8,000 Equity Shares) and Sanjay Bhagwanji Bole (8,000 Equity Shares).

- (8) [Allotment of 2,630,000 Equity Shares to 10 allottees, i.e., Rupesh Dayashankar Madeka 427,636 Equity Shares), Jiten Dayashankar Madeka (427,636 Equity Shares), Manesh Dayashankar Madeka (467,846 Equity Shares), Ashok Dayashankar Madeka (146,590 Equity Shares), Pinakin Dayashankar Madeka (506,359 Equity Shares), Bhautik Dayashankar Madeka (375,930 Equity Shares), Bharat Jiten Madeka (80,181 Equity Shares), Mihir Rupeshkumar Madeka (80,181 Equity Shares), Hemal Paresh Madeka (37,460 Equity Shares) and Sanjay Bhagwanji Bole (80,181 Equity Shares).]

## B. History of Preference Share Capital of our Company

The history of the preference share capital of our Company is provided in the following table:

Date of allotment	Number of CCPS allotted	Face value (₹)	Offer price per CCPS (₹)	Nature of consideration	Nature of allotment	Cumulative number of CCPS	Cumulative paid-up CCPS capital (₹)
<b>CCPS</b>							
September 28, 2007	1,425	35,000	529,850	Cash	Preferential Allotment <sup>(1)</sup>	1,425	49,875,000
December 14, 2007	1,425	35,000	529,850	Cash	Preferential Allotment <sup>(2)</sup>	2,850 <sup>(3)</sup>	99,750,000

<sup>(1)</sup> Allotment of 1,425 CCPS to one allottee i.e. Rivendell PE LLC.

<sup>(2)</sup> Allotment of 1,425 CCPS to one allottee i.e. Rivendell PE LLC.

<sup>(3)</sup> 9,975,000 Equity Shares were allotted to Rivendell PE LLC upon conversion of 2,850 CCPS on April 26, 2010. For details, see "History of Equity Share capital of our Company".

Date of allotment	Number of NCRPS allotted	Face value (₹)	Offer price per NCRPS (₹)	Nature of consideration	Nature of allotment	Cumulative number of NCRPS	Cumulative paid-up NCRPS Capital (₹)
<b>NCRPS</b>							
December 31, 2013	6,680,000	10	10	Cash	Preferential Allotment <sup>(1)</sup>	6,680,000	66,800,000
February 22, 2014	1,680,000	10	10	Cash	Preferential Allotment <sup>(2)</sup>	8,360,000	83,600,000
December 29, 2014	5,245,863	10	10	Cash	Rights Issue <sup>(3)</sup>	13,605,863	136,058,630

<sup>(1)</sup> Allotment of 6,680,000 NCRPS to 11 allottees, i.e., Rupesh Dayashankar Madeka (3,050,000 NCRPS), Jiten Dayashankar Madeka (975,000 NCRPS), Manesh Dayashankar Madeka (100,000 NCRPS), Ashok Dayashankar Madeka (105,000 NCRPS), Pinakin Dayashankar Madeka (480,000 NCRPS), Bhautik Dayashankar Madeka (1,240,000 NCRPS), Paresh Dayashankar Madeka (70,000 NCRPS), Mihir Rupeshkumar Madeka (65,000 NCRPS), Hemal Paresh Madeka (75,000 NCRPS), Bharat Jiten Madeka (45,000 NCRPS) and Sanjay Bhagwanji Bole (475,000 NCRPS).

<sup>(2)</sup> Allotment of 1,680,000 NCRPS to 5 allottees, i.e., Manesh Dayashankar Madeka (630,000 NCRPS), Bhautik Dayashankar Madeka (250,000 NCRPS), Mihir Rupeshkumar Madeka (300,000 NCRPS), Ashok Dayashankar Madeka (250,000 NCRPS) and Bharat Jiten Madeka (250,000 NCRPS).

<sup>(3)</sup> Rights issue of 5,245,863 NCRPS, in the ratio of 7 NCRPS for every 32 Equity Shares held, to 11 allottees, i.e., Rupesh Dayashankar Madeka (839,338 NCRPS), Jiten Dayashankar Madeka (839,338 NCRPS), Manesh Dayashankar Madeka (839,338 NCRPS), Ashok Dayashankar Madeka (524,586 NCRPS), Pinakin Dayashankar Madeka (891,797 NCRPS), Bhautik Dayashankar Madeka (577,045 NCRPS), Paresh Dayashankar Madeka (104,917 NCRPS), Mihir Rupeshkumar Madeka (157,376 NCRPS), Hemal Paresh Madeka (157,376 NCRPS), Bharat Jiten Madeka (157,376 NCRPS) and Sanjay Bhagwanji Bole (157,376 NCRPS).

<sup>(4)</sup> The Board of Directors and the Shareholders, in their meeting dated March 12, 2021, have approved the change in tenor of redemption from completion of 10 years from the date of allotment to completion of 10 years from the date of allotment or upon listing of Equity Shares of the Company on the Stock Exchanges, whichever is earlier. The same was approved by Shareholders in the extra-ordinary general meeting dated March 12, 2021.

Date of allotment	Number of OCRPS allotted	Face value (₹)	Offer price per OCRPS (₹)	Nature of consideration	Nature of allotment	Cumulative number of OCRPS	Cumulative paid-up OCRPS Capital (₹)
<b>OCRPS</b>							
March 3, 2021	2,630,000	10	10	Cash	Rights Issue <sup>(1)</sup>	2,630,000	2,630,000

(1) Allotment of 2,630,000 OCRPS, in the ratio of 9 OCRPS for every 44 Equity Shares held, to 10 allottees, i.e., Rupesh Dayashankar Madeka (427,636 OCPRS), Jiten Dayashankar Madeka (427,636 OCPRS), Manesh Dayashankar Madeka (467,846 OCPRS), Ashok Dayashankar Madeka (146,590 OCPRS), Pinakin Dayashankar Madeka (506,359 OCPRS), Bhautik Dayashankar Madeka (375,930 OCPRS), Mihir Rupeshkumar Madeka (80,181 OCPRS), Hemal Paresh Madeka (37,460 OCPRS), Bharat Jiten Madeka (80,181 OCPRS) and Sanjay Bhagwanji Bole (80,181 OCPRS).

(2) The OCRPS were converted into Equity Shares in the ratio of 1:1 on July 16, 2021.

**C. Shares issued for consideration other than cash or out of revaluation reserves**

Except upon incorporation when shares were issued to the subscribers of Memorandum of Association pursuant to conversion of partnership into Company, our Company has not issued Equity Shares or preference shares for consideration other than cash or through bonus issue on the date of this Prospectus. Our Company has not issued any Equity Shares or preference shares out of revaluation reserves since incorporation.

**D. Issue of Equity Shares pursuant to schemes of arrangement**

Our Company has not allotted any Equity Shares pursuant to any scheme of arrangement approved under sections 391-394 of the Companies Act, 1956 or sections 230-234 of the Companies Act, 2013, as applicable.

**E. Issue of Equity Shares at a price lower than the Offer Price in the last year**

The Offer Price for the Equity Shares is ₹ 900. For details of the allotments made in the last one year, see “History of Equity Share Capital of our Company” on page 64.

**F. Issue of Equity Shares under employee stock option schemes**

As on the date of this Prospectus, our Company has not made any issuance of Equity Shares under any employee stock option scheme. Further, our Company has no employee stock option scheme in existence, as on the date of this Prospectus.

**2. History of build-up of Promoters’ shareholding and lock-in of Promoter’s shareholding including Promoter’s contribution)**

As on the date of this Prospectus, our Promoters hold, in aggregate, 12,987,407 Equity Shares, which constitute 48.80% of the issued, subscribed and paid-up Equity Share capital of our Company. The details regarding our Promoter’s shareholding is set out below:

**a) Build-up of Promoter’s shareholding in our Company**

Set forth below is the build-up of our Promoter’s shareholding since the incorporation of our Company:

**(I.) Equity Shares^**

Date of allotment/ transfer	Nature of transaction	Number of Equity Shares	Nature of consideration	Face value per Equity Share (₹)	Issue/acquisition/transfer price per Equity Share (₹)	% of the pre- Offer Equity Share capital*	% of the post- Offer share capital
<b>Rupesh Dayashankar Madeka</b>							
February 13, 2003	Subscription to MOA	14	Conversion of partnership firm to Company	100,000	100,000	0.53 <sup>#</sup>	0.51
March 31, 2003	Further Issue	154	Cash	100,000	100,000	5.79 <sup>#</sup>	5.65
Pursuant to the ordinary resolution passed by shareholders dated August 22, 2007, our Company sub-divided the face value of its Equity Shares from ₹ 100,000 each to ₹ 10 each.							
August 22, 2007	Acquisition of Equity Shares from Ashok Dayashankar Madeka	240,000	Cash	10	10	0.90	0.88
August 10, 2010	Rights Issue	64,000	Cash	10	140	0.24	0.23
October 12, 2010	Rights Issue	64,000	Cash	10	140	0.24	0.24
December 2, 2010	Rights Issue	42,667	Cash	10	140	0.16	0.16
July 16, 2021	Conversion from OCRPS	427,636	Cash	10	10	0.61	1.57
<b>Total</b>		<b>2,518,303</b>				<b>9.46</b>	<b>9.25</b>
<b>Manesh Dayashankar Madeka</b>							
February 13, 2003	Subscription to MOA	15	Conversion of partnership firm to Company	100,000	100,000	0.56 <sup>#</sup>	0.55
March 31, 2003	Further Issue	165	Cash	100,000	100,000	6.20 <sup>#</sup>	6.06
Pursuant to the ordinary resolution passed by shareholders dated August 22, 2007, our Company sub-divided the face value of its Equity Shares from ₹ 100,000 each to ₹ 10 each.							
August 22, 2007	Acquisition of Equity Shares from Jiten Dayashankar Madeka	120,000	Cash	10	10	0.545	0.44
August 10, 2010	Rights Issue	64,000	Cash	10	140	0.24	0.24
October 12, 2010	Rights Issue	64,000	Cash	10	140	0.24	0.24
December 2, 2010	Rights Issue	42,667	Cash	10	140	0.16	0.16
February 25, 2021	Transfer of Equity Shares from Ashok Dayashankar Madeka by way of gift	196,585	NA	10	NA	0.74	0.72
July 16, 2021	Conversion from OCRPS	467,846	Cash	10	10	1.76	1.72

Date of allotment/ transfer	Nature of transaction	Number of Equity Shares	Nature of consideration	Face value per Equity Share (₹)	Issue/acquisition/transfer price per Equity Share (₹)	% of the pre- Offer Equity Share capital*	% of the post- Offer share capital
<b>Total</b>		<b>2,755,098</b>				<b>10.35</b>	<b>10.12</b>
<b>Pinakin Dayashankar Madeka</b>							
February 13, 2003	Subscription to MOA	17	Conversion of partnership firm to Company	100,000	100,000	0.64 <sup>#</sup>	0.62
March 31, 2003	Further Issue	187	Cash	100,000	100,000	7.03 <sup>#</sup>	6.87
Pursuant to the ordinary resolution passed by shareholders dated August 22, 2007, our Company sub-divided the face value of its Equity Shares from ₹ 100,000 each to ₹ 10 each.							
August 10, 2010	Rights Issue	68,000	Cash	10	140	0.26	0.25
October 12, 2010	Rights Issue	68,000	Cash	10	140	0.26	0.25
December 2, 2010	Rights Issue	45,333	Cash	10	140	0.17	0.17
February 25, 2021	Transfer of Equity Shares from Ashok Dayashankar Madeka by way of gift	254,200	NA	10	NA	0.96	0.93
July 16, 2021	Conversion from OCRPS	506,359	Cash	10	10	1.90	1.86
<b>Total</b>		<b>2,981,892</b>				<b>11.21</b>	<b>10.95</b>
<b>Bhautik Dayashankar Madeka</b>							
February 13, 2003	Subscription to MOA	10	Conversion of partnership firm to Company	100,000	100,000	0.38 <sup>#</sup>	0.37
March 31, 2003	Further Issue	110	Cash	100,000	100,000	4.13 <sup>#</sup>	4.04
Pursuant to the ordinary resolution passed by shareholders dated August 22, 2007, our Company sub-divided the face value of its Equity Shares from ₹ 100,000 each to ₹ 10 each.							
August 22, 2007	Acquisition of Equity Shares from Paresh Dayashankar Madeka	120,000	Cash	10	10	0.45	0.44
August 10, 2010	Rights Issue	44,000	Cash	10	140	0.17	0.16
October 12, 2010	Rights Issue	44,000	Cash	10	140	0.17	0.16
December 2, 2010	Rights Issue	29,333	Cash	10	140	0.11	0.11
February 25, 2021	Transfer of Equity Shares	261,333	NA	10	NA	0.98	0.96



Date of allotment/ transfer	Nature of transaction	Number of Equity Shares	Nature of consideration	Face value per Equity Share (₹)	Issue/acquisition/transfer price per Equity Share (₹)	% of the pre-Offer Equity Share capital*	% of the post-Offer share capital
	from Paresh Dayashankar Madeka by way of gift						
February 25, 2021	Transfer of Equity Shares from Ashok Dayashankar Madeka by way of gift	139,215	NA	10	NA	0.52	0.51
July 16, 2021	Conversion from OCRPS	375,930	Cash	10	10	1.41	1.38
<b>Total</b>		<b>2,213,811</b>				<b>8.32</b>	<b>8.13</b>
<b>Jiten Dayashankar Madeka</b>							
February 13, 2003	Subscription to MOA	17	Conversion of partnership firm into Company	100,000	100,000	0.64 <sup>#</sup>	0.62
March 31, 2003	Further Issue	187	Cash	100,000	100,000	7.03 <sup>#</sup>	6.87
Pursuant to the ordinary resolution passed by shareholders dated August 22, 2007, our Company sub-divided the face value of its Equity Shares from ₹ 100,000 each to ₹ 10 each.							
August 22, 2007	Sale of Equity Shares to Manesh Dayashankar Madeka	(120,000)	Cash	10	10	(0.45)	
August 10, 2010	Rights Issue	64,000	Cash	10	140	0.24	0.24
October 12, 2010	Rights Issue	64,000	Cash	10	140	0.24	0.24
December 2, 2010	Rights Issue	42,667	Cash	10	140	0.16	0.16
July 16, 2021	Conversion from OCRPS	427,636	Cash	10	10	1.61	1.57
<b>Total</b>		<b>2,518,303</b>				<b>9.46</b>	<b>9.25</b>

<sup>^</sup> In terms of pledge agreement dated January 11, 2011 and supplemental pledge agreement dated March 28, 2013 entered into amongst the Consortium Lenders, our Promoters and certain members of our Promoter Group, the Consortium Lenders had agreed to extend our Company loan facilities on the terms and conditions contained in the respective sanction letters, secured, inter alia, by a pledge in favour of the Consortium Lenders of 54.49% of the fully paid-up Equity Share capital of the Company. Pursuant to the Waiver Letters, the Consortium Lenders have released pledge on such number of Equity Shares which are required towards fulfilling minimum promoter contribution in order to comply with Regulation 14 of the SEBI ICDR Regulations. Further, the Consortium Lenders have also released the residual physical share certificates to facilitate the process of dematerialization of the Equity Shares. Pursuant to dematerialisation of the Equity Shares and in compliance with the pledge agreements, the Promoters and certain members of the Promoter Group have created lock-in on the residual Equity Shares (i.e. other than the Equity Shares earmarked towards minimum promoter contribution) ("**Residual Equity Shares**") to comply with the requirement of Regulation 17 of SEBI ICDR Regulations and are in the process of creating pledge on the Residual Equity Shares in terms of Regulation 21(b) of SEBI ICDR Regulations. Further, 26,30,000 Equity Shares issued pursuant to conversion of OCRPS will also be pledged in accordance with the provision of pledge agreement.

<sup>#</sup> Percentage is calculated after taking into account the sub-division of shares from ₹ 100,000 each to ₹ 10 each.

## (II.) NCRPS^

Date of allotment / transfer	Nature of transaction	Number of preference shares allotted/transferred	Nature of consideration	Face value per preference share (₹)	Issue/acquisition/transfer price per NCRPS (₹)	% of the pre-Offer NCRPS share capital	% of the post-Offer NCRPS share capital
<b>Rupesh Dayashankar Madeka</b>							
December 31, 2013	Preferential Allotment	3,050,000	Cash	10	10	22.42	22.42
December 29, 2014	Rights Issue	839,338	Cash	10	10	6.17	6.17
<b>Total</b>		<b>3,889,338</b>				<b>28.59</b>	<b>28.59</b>
<b>Manesh Dayashankar Madeka</b>							
December 31, 2013	Preferential Allotment	100,000	Cash	10	10	0.73	0.73
February 22, 2014	Preferential Allotment	630,000	Cash	10	10	4.63	4.63
December 29, 2014	Rights Issue	839,338	Cash	10	10	6.17	6.17
<b>Total</b>		<b>1,569,338</b>				<b>11.53</b>	<b>11.53</b>
<b>Pinakin Dayashankar Madeka</b>							
December 31, 2013	Preferential Allotment	480,000	Cash	10	10	3.53	3.53
December 29, 2014	Rights Issue	891,797	Cash	10	10	6.55	6.55
<b>Total</b>		<b>1,371,797</b>				<b>10.08</b>	<b>10.08</b>
<b>Bhautik Dayashankar Madeka</b>							
December 31, 2013	Preferential Allotment	1,240,000	Cash	10	10	9.11	9.11
February 22, 2014	Preferential Allotment	250,000	Cash	10	10	1.84	1.84
December 29, 2014	Rights Issue	577,045	Cash	10	10	4.24	4.24
<b>Total</b>		<b>2,067,045</b>				<b>15.19</b>	<b>15.19</b>
<b>Jiten Dayashankar Madeka</b>							
December 31, 2013	Preferential Allotment	975,000	Cash	10	10	7.17	7.17
December 29, 2014	Rights Issue	839,338	Cash	10	10	6.17	6.17
<b>Total</b>		<b>1,814,338</b>				<b>13.33</b>	<b>13.33</b>

<sup>^</sup>In terms of pledge agreement dated September 24, 2018 entered between the Consortium Lenders, our Promoters and certain members of our Promoter Group, the Consortium Lenders had agreed to extend our Company loan facilities on the terms and conditions contained in the respective sanction letters, secured, inter alia, by a pledge in favour of the Consortium Lenders 100% of the fully paid-up NCRPS of the Company from time to time. The Consortium Lenders have released the physical share certificates to facilitate the process of dematerialization of the NCRPS. Pursuant to dematerialisation of the NCRPS and

in compliance with the pledge agreements, the Promoters and certain members of the Promoter Group are in the process of creating pledge on the NCRPS.

All the Equity Shares and preference shares held by our Promoters are fully paid-up on the respective dates of acquisition of such Equity Shares.

**b) Shareholding of our Promoters and the members of our Promoter Group**

Set forth below is the equity shareholding of our Promoters and Promoter Group as on the date of this Prospectus:

Name of shareholder	No. of Equity Shares	Pre-Offer Percentage of pre-Offer equity capital (%)	Post-Offer No. of Shares	Equity Percentage of post-Offer capital
<b>Promoter</b>				
Rupesh Dayashankar Madeka	2,518,303	9.46	2,518,303	9.25
Manesh Dayashankar Madeka	2,755,098	10.35	2,755,098	10.12
Pinakin Dayashankar Madeka	2,981,892	11.21	2,981,892	10.95
Bhautik Dayashankar Madeka	2,213,811	8.32	2,213,811	8.13
Jiten Dayashankar Madeka	2,518,303	9.46	2,518,303	9.25
<b>Total (A)</b>	<b>12,987,407</b>	<b>48.80</b>	<b>12,987,407</b>	<b>47.69</b>
<b>Promoter Group</b>				
Ashok Dayashankar Madeka	863,257	3.24	863,257	3.17
Paresh Dayashankar Madeka	72,000	0.27	72,000	0.26
Mihir Rupeshkumar Madeka	472,181	1.77	472,181	1.73
Hemal Paresh Madeka	357,460	1.34	357,460	1.31
Sanjay Bhagwanji Bole	472,181	1.77	472,181	1.73
Bharat Jiten Madeka	472,181	1.77	472,181	1.74
<b>Total (B)</b>	<b>2,709,260</b>	<b>10.18</b>	<b>2,709,260</b>	<b>9.95</b>
<b>Total (A+B)</b>	<b>15,696,667</b>	<b>58.99</b>	<b>15,696,667</b>	<b>57.64</b>

**c) Details of Promoters' contribution locked in for three years**

Pursuant to Regulations 14 and 16 of the SEBI ICDR Regulations, an aggregate of 20% of the fully diluted post-Offer Equity Share capital of our Company held by our Promoters shall be considered as minimum promoters' contribution and locked-in for a period of three years from the date of Allotment ("Promoter's Contribution"). Our Promoter's shareholding in excess of 20% shall be locked in for a period of one year from the Allotment. As on the date of this Prospectus, our Promoter holds 12,987,407 Equity Shares, constituting 48.80% of our Company's issued, subscribed and paid-up equity share capital.

Our Promoters have given consent to include such number of Equity Shares held by them, in aggregate, as may constitute 20% of the fully diluted post-Offer Equity Share capital of our Company as Promoter's Contribution. Our Promoters have agreed not to dispose, sell, transfer, charge, pledge or otherwise encumber in any manner the Promoters' Contribution from the date of this Prospectus, until the expiry of the lock-in period specified above, or for such other time as required under SEBI ICDR Regulations. Details of Promoters' Contribution are as provided below:

Name of the Promoter	No. of Equity Shares* locked-in	Date of allotment/transfer#	Face value per Equity Share (₹)	Allotment/ Acquisition price per Equity Share (₹)	Nature of transaction	% of the fully diluted post-Offer paid-up Capital	Date up to which the Equity Shares are subject to lock-in
Rupesh Dayashankar Madeka	1,925,000	1,40,000 – 13/02/2003	100000/- (Rs. 10/- after Sub Division)	100000/- (Rs. 10/- after Sub Division)	Subscription to MoA	7.07	Three years from the date of Allotment
		15,40,000 – 31/03/2003	100000/- (Rs. 10/- after Sub Division)	100000/- (Rs. 10/- after Sub Division)	Further Issue		
		2,40,000 – 22/08/2007	10/-	10/-	Acquisition through Share Transfer		
		5,000 – 10/08/2010	10/-	140/-	Right Issue		
Jiten Dayashankar Madeka	1,600,000	1,70,000 – 13/02/2003	100000/- (Rs. 10/- after Sub Division)	100000/- (Rs. 10/- after Sub Division)	Subscription to MoA	5.88	Three years from the date of Allotment
		14,30,000 – 31/03/2003	100000/- (Rs. 10/- after Sub Division)	100000/- (Rs. 10/- after Sub Division)	Further Issue		
Manesh Dayashankar Madeka	1,921,663	1,50,000 – 13/02/2003	100000/- (Rs. 10/- after Sub Division)	100000/- (Rs. 10/- after Sub Division)	Subscription to MoA	7.06	Three years from the date of Allotment
		16,50,000 – 31/03/2003	100000/- (Rs. 10/- after Sub Division)	100000/- (Rs. 10/- after Sub Division)	Further Issue		
		1,20,000 – 22/08/2007	10/-	10/-	Acquisition through Share Transfer		
				140/-			

Name of the Promoter	No. of Equity Shares* locked-in	Date of allotment/transfer#	Face value per Equity Share (₹)	Allotment/ Acquisition price per Equity Share (₹)	Nature of transaction	% of the fully diluted post-Offer paid-up Capital	Date up to which the Equity Shares are subject to lock-in
		1,663 – 10/08/2010			Right Issue		
<b>Total</b>	<b>5,446,663</b>					<b>20.00</b>	

# Equity Shares were fully paid-up on the date of allotment/acquisition

The Equity Shares that are being locked-in for computation of Promoters' Contribution are not and will not be ineligible under Regulation 15 of the SEBI ICDR Regulations. In particular, these Equity Shares do not and shall not consist of:

- (i) Equity Shares acquired during the three years preceding the date of this Prospectus (a) for consideration other than cash and revaluation of assets or capitalisation of intangible assets, or (b) as a result of bonus shares issued by utilization of revaluation reserves or unrealised profits or from bonus issue against Equity Shares which are otherwise ineligible for computation of Promoters' Contribution;
- (ii) Equity Shares acquired during the one year preceding the date of this Prospectus, at a price lower than the price at which the Equity Shares are being offered to the public in the Offer;
- (iii) Our Company was incorporated pursuant to conversion of a partnership firm into a company in the year 2003. No Equity Shares have been issued to our Promoters upon such conversion, in the last one year; and
- (iv) The Equity Shares forming part of the Promoters' Contribution are not subject to any pledge.

### 3. Details of share capital locked-in for one year

In terms of the SEBI ICDR Regulations, except for:

- (i) the Promoters' Contribution which shall be locked in as above; and
- (ii) the Equity Shares sold or transferred by the Selling Shareholder (i.e. Rivendell PE LLC) pursuant to the Offer for Sale.

the entire pre-Offer Equity Share capital of our Company (including those Equity Shares held by our Promoter in excess of Promoter's Contribution), shall be locked in for a period of one year from the date of Allotment. Any unsubscribed portion of the Equity Shares being offered by the Selling Shareholder (i.e. Rivendell PE LLC) in the Offer for Sale would also be locked-in as required under the SEBI ICDR Regulations.

In terms of Regulation 22 of the SEBI ICDR Regulations, Equity Shares held by our Promoters which are locked-in, may be transferred to Promoters or members of the Promoter Group or to any new Promoters, subject to continuation of lock-in in the hands of the transferees for the remaining period and compliance with provisions of the Takeover Regulations, as applicable and such transferee shall not be eligible to transfer them till the lock-in period stipulated in SEBI ICDR Regulations has expired. The Equity Shares held by persons other than our Promoters and locked-in for a period of one year from the date of Allotment in the Offer, may be transferred to any other person holding Equity Shares which are locked -in, subject to the continuation of the lock-in in the hands of the transferee for the remaining period and compliance with the provisions of the Takeover Regulations. However, it should be noted that the Offered Shares which will be transferred by the Selling Shareholder (i.e. Rivendell PE LLC) pursuant to the Offer for Sale shall not be subject to lock-in.

In terms of Regulation 21 of the SEBI ICDR Regulations, the Equity Shares held by our Promoters which are locked-in as per Regulation 16 of the SEBI ICDR Regulations, may be pledged only with scheduled commercial banks or public financial institutions or systemically important non-banking finance companies or deposit taking housing finance companies as collateral security for loans granted by such entity, provided that: (i) in case of Equity Shares locked-in for three years, such Equity Shares may be pledged only if the loan has been granted to our Company, for the purpose of financing one or more of the objects of the Offer, and pledge of the Equity Shares is a term of sanction of such loans; and (ii) in case of Equity Shares locked-in for a period of one year, the pledge of the Equity Shares is one of the terms of the sanctioned loan. Provided that the lock-in of Equity Shares shall continue for the remaining period with the transferee and such transferee shall not be eligible to transfer them till the lock-in period stipulated in these regulations has expired.

***Lock-in of Equity Shares Allotted to Anchor Investors***

Any Equity Shares Allotted to Anchor Investors in the Anchor Investor Portion shall be locked in for a period of 30 days from the date of Allotment.

- 4. *Sales or purchases of Equity Shares or other specified securities of our Company by our Promoter, the other members of our Promoter Group or our Directors or their relatives during the six months immediately preceding the date of this Prospectus.***

None of our Promoter, other members of our Promoter Group, our Directors or their relatives have sold or purchased any Equity Shares or other specified securities of our Company during the six months immediately preceding the date of this Prospectus except as disclosed at *History of build-up of Promoters' shareholding and lock-in of Promoter's shareholding including Promoter's contribution* beginning on page 67.

5. *Our shareholding pattern*

The table below represents the equity shareholding pattern of our Company as on the date of this Prospectus:

Category (I)	Category of Shareholder (II)	Number of Shareholders (III)	No. of fully paid up Equity Shares held (IV)	No. of Partly paid-up equity shares held (V)	No. of shares underlying depository receipts (VI)	Total nos. shares held (VII) = (IV)+(V)+(VI)	Shareholding as a % of total no. of shares (calculated as per SCRR, 1957) (VIII) As a % of (A+B+C2)	Number of Voting Rights held in each class of securities (IX)				No. of shares underlying outstanding convertible securities (including warrants) (X)	Shareholding as a % assuming full conversion of convertible securities (as a percentage of diluted share capital) (XI) = (VII)+(X) As a % of (A+B+C2)	Number of locked in shares (XII)		Number of Shares pledged or otherwise encumbered (XIII)		Number of Equity Shares held in dematerialised form (XIV)
								No of Voting Rights						No. (a)	As a % of total Shares held (b)	No. (a)	As a % of total Shares held (b)	
								Class	Class	Total	Total as a % of (A+B+C)							
								Equity	NA									
(A)	<b>Promoter and Promoter Group</b>	11	15,696,667	-	-	15,696,667	58.99%	58.99%	-	58.99%	-	58.99	72,01,560	45.88%	**			15,696,667
(B)	<b>Public</b>	1	10,914,423	-	-	10,914,423	41.01%	41.01%	-	41.01%	-	41.01	-	-	-	-	-	10,914,423
(C)	<b>Non Promoter-Non Public</b>	-	-	-	-	-	-	-	-	-	-	-	-	-	-	-	-	-
(C) (1)	Shares underlying DRs	-	-	-	-	-	-	-	-	-	-	-	-	-	-	-	-	-
(C) (2)	Shares held by Employee Trusts	-	-	-	-	-	-	-	-	-	-	-	-	-	-	-	-	-
	<b>Total (A) + (B) + (C)</b>	12	26,611,090	-	-	26,611,090	100%	100%	-	100%	-	100.00%	-	-	**			26,611,090

*\*\* In accordance with the CDR Package, the Equity Shares held by promoters and promoter group are pledged with the Consortium Lenders. In order to facilitate this Offer, the Consortium Lenders have de-pledged the Equity Shares to the extent of minimum promoter contribution to enable the Promoters to comply with Regulation 14 of the SEBI ICDR Regulations. Further, the Consortium Lender have released the physical certificates of the residual pledged Equity Shares (i.e. other than the Equity Shares earmarked towards minimum promoter contribution) and NCRPS to facilitate the process of dematerialization of the Equity Shares and NCRPS. Pursuant to dematerialisation of the Equity Shares and NCRPS and in compliance with CDR Package, the Promoters and members of the Promoter Group have created lock-in on the residual Equity Shares (i.e. other than the Equity Shares earmarked towards minimum promoter contribution) ("Residual Equity Shares") to comply with the requirement of Regulation 17 of SEBI ICDR Regulations and are in the process of creating pledge on the NCRPS and the Residual Equity Shares in terms of Regulation 21(b) of SEBI ICDR Regulations. Further 26,30,000 Equity Shares issued pursuant to conversion of OCRPS will also be pledged in accordance with the provision of pledge agreement. For details, see "History and Certain Corporate Matters" at page 131.*

6. As on the date of this Prospectus, our Company has 12 shareholders of Equity Shares.

7. **Equity Shares held by the Shareholders holding 1% or more of the paid-up capital of our Company**

The Shareholders holding 1% or more of the equity paid-up capital of our Company as on the date of this Prospectus are as follows:

Sr. No.	Shareholder	Number of Equity Shares held	Percentage of pre-Offer share capital (%)
1.	Rupesh Dayashankar Madeka	2,518,303	9.46
2.	Jiten Dayashankar Madeka	2,518,303	9.46
3.	Manesh Dayashankar Madeka	2,755,098	10.35
4.	Ashok Dayashankar Madeka	863,257	3.24
5.	Pinakin Dayashankar Madeka	2,981,892	11.21
6.	Bhautik Dayashankar Madeka	2,213,811	8.32
7.	Paresh Dayashankar Madeka	72,000	0.27
8.	Mihir Rupeshkumar Madeka	472,181	1.77
9.	Hemal Paresh Madeka	357,460	1.34
10.	Sanjay Bhagwanji Bole	472,181	1.77
11.	Bharat Jiten Madeka	472,181	1.77
12.	Rivendell PE LLC (Formerly, NSR-PE Mauritius LLC )	10,914,423	41.01
	<b>Total</b>	<b>26,611,090</b>	<b>100.00</b>

The Shareholders holding 1% or more of the equity paid-up capital of our Company ten days prior to the date of this Prospectus is as follows:

Sr. No.	Shareholder	Number of Equity Shares held	Percentage of pre-Offer share capital (%)
1.	Rupesh Dayashankar Madeka	2,090,667	8.72
2.	Jiten Dayashankar Madeka	2,090,667	8.72
3.	Manesh Dayashankar Madeka	2,287,252	9.54
4.	Ashok Dayashankar Madeka	716,667	2.99
5.	Pinakin Dayashankar Madeka	2,475,533	10.32
6.	Bhautik Dayashankar Madeka	1,837,881	7.66
7.	Paresh Dayashankar Madeka	72,000	0.30
8.	Mihir Rupeshkumar Madeka	392,000	1.63
9.	Hemal Paresh Madeka	320,000	1.33
10.	Sanjay Bhagwanji Bole	392,000	1.63
11.	Bharat Jiten Madeka	392,000	1.63
12.	Rivendell PE LLC (Formerly, NSR-PE Mauritius LLC )	10,914,423	45.51
	<b>Total</b>	<b>23,981,090</b>	<b>100</b>

The Shareholders holding 1% or more of the equity paid-up capital of our Company as on one year prior to the date of this Prospectus and as on two years prior to filing of this Prospectus are as follows:

Sr. No.	Shareholder	Number of Equity Shares held	Percentage of pre-Offer share capital (%)
1.	Rupesh Dayashankar Madeka	2,090,667	8.72
2.	Jiten Dayashankar Madeka	2,090,667	8.72
3.	Manesh Dayashankar Madeka	2,090,667	8.72
4.	Ashok Dayashankar Madeka	1,306,667	5.45
5.	Pinakin Dayashankar Madeka	2,221,333	9.26
6.	Bhautik Dayashankar Madeka	1,437,333	5.99
7.	Paresh Dayashankar Madeka	261,333	1.09
8.	Mihir Rupeshkumar Madeka	392,000	1.63
9.	Hemal Paresh Madeka	392,000	1.63



Sr. No.	Shareholder	Number of Equity Shares held	Percentage of pre-Offer share capital (%)
10.	Sanjay Bhagwanji Bole	392,000	1.63
11.	Bharat Jiten Madeka	392,000	1.63
12.	Rivendell PE LLC (Formerly, NSR-PE Mauritius LLC )	10,914,423	45.51
	<b>Total</b>	<b>23,981,090</b>	<b>100</b>

8. None of the Equity Shares being offered for sale through the Offer for Sale are pledged or otherwise encumbered, as on the date of this Prospectus
9. Our Company, our Directors and the BRLMs have not made or entered into any buy-back arrangements for the purchase of Equity Shares.
10. Neither the BRLMs and nor their respective associates as defined in the SEBI Merchant Bankers Regulations, hold any Equity Shares as on the date of filing of this Prospectus. The BRLMs and their affiliates may engage in transactions with and perform services for our Company in the ordinary course of business or may in the future engage in commercial banking and investment banking transactions with our Company and/or our Subsidiaries, for which they may in the future receive customary compensation.
11. No person connected with the Offer, including, but not limited to the BRLMs, the Syndicate Members, our Company, the Selling Shareholder (i.e. Rivendell PE LLC), our Directors, or the members of the Promoter Group, shall offer in any manner whatsoever any incentive, whether direct or indirect, in cash or kind or services or otherwise to any Bidder for making a Bid, except for fees or commission for services rendered in relation to the Offer.
12. The Equity Shares are fully paid-up and there are no partly paid-up Equity Shares as on the date of filing of this Prospectus. The Equity Shares to be issued or transferred pursuant to the Offer shall be fully paid-up at the time of Allotment, failing which no Allotment shall be made.
13. All the shares held by our Promoters, Directors and Selling Shareholder (i.e. Rivendell PE LLC) are in dematerialised as on the date of this Prospectus.
14. Our Company has no outstanding warrants, options to be issued or rights to convert debentures or other convertible instruments into Equity Shares as on the date of this Prospectus, however, in terms of the facility agreements and sanction letters, our lenders may convert at their option the whole of the outstanding amount of the facilities and/or 20% of the defaulted amount into fully paid-up equity shares in our Company as a consequence of occurrence of events of default. For details, see “*Risk Factors*” on page 22.
15. Except for the Equity Shares to be allotted pursuant to (i) the Fresh Issue; and (ii) Offer for Sale, our Company presently does not intend or propose or is under negotiation or consideration to alter its capital structure for a period of six months from the Bid/ Offer Opening Date, by way of split or consolidation of the denomination of Equity Shares or further issue of Equity Shares (including issue of securities convertible into or exchangeable for, directly or indirectly into Equity Shares), whether on a preferential basis or issue of bonus or rights or further public issue of Equity Shares.
16. Except for the allotment of Equity Shares pursuant to the (i) Fresh Issue, and (ii) Offer for Sale, there will be no further issue of Equity Shares whether by way of issue of bonus shares, preferential allotment, rights issue or in any other manner during the period commencing from filing of this Prospectus with SEBI until the Equity Shares have been listed on the Stock Exchanges or all application moneys have been refunded to the Anchor Investors, or the application moneys are unblocked in the ASBA Accounts on account of non-listing, under-subscription etc, as the case may be.
17. During the period of six months immediately preceding the date of filing of this Prospectus, no financing arrangements existed whereby our Promoter, other members of our Promoter Group, our Directors or their relatives may have financed the purchase of securities of our Company by any other person.

- 18.** Our Promoter and members of our Promoter Group will not submit Bids, or otherwise participate in this Offer.
- 19.** The BRLMs and any person related to the BRLMs or Syndicate Members cannot apply in the Offer under the Anchor Investor Portion, except for Mutual Funds sponsored by entities which are associate of the BRLMs or insurance companies promoted by entities which are associates of the BRLMs or AIFs sponsored by the entities which are associate of the BRLMs and FPIs (other than individuals, corporate bodies and family offices) sponsored by entities which are associate of the BRLMs.
- 20.** There shall be only one denomination of the Equity Shares, unless otherwise permitted by law.
- 21.** Our Company shall ensure that transactions in the Equity Shares by the Promoter and the Promoter Group, if any, during the period between the date of filing of the Draft Red Herring Prospectus and the date of closure of the Offer shall be reported to the Stock Exchanges within 24 hours of the transactions.

## OBJECTS OF THE OFFER

The Offer comprises of the Fresh Issue and the Offer for Sale.

### Offer for Sale

The proceeds from the Offer for Sale (net of Offer related expenses to be borne by the Selling Shareholder) shall be received by the Selling Shareholder (i.e. Rivendell PE LLC) and our Company shall not receive any proceeds from the Offer for Sale.

### Objects of the Fresh Issue

Our Company proposes to utilize the Net Proceeds from the Fresh Issue towards funding the following objects:

1. Funding long-term working capital requirements; and
2. General corporate purposes.

In addition, our Company expects to receive the benefits of listing of the Equity Shares on the Stock Exchanges and enhancement of our Company's brand name amongst our existing and potential customers and creation of a public market for our Equity Shares in India.

The main objects clause and objects incidental and ancillary to the main objects clause as set out in the Memorandum of Association enables our Company to undertake its existing activities and the activities for which funds are proposed to be raised by our Company through the Fresh Issue.

### Net Proceeds

The following table sets forth details of the Net Proceeds:

Particulars	Estimated Amount (in ₹ million) <sup>(1)</sup>
Gross proceeds from the Fresh Issue	560
Less Offer related expenses to be borne by our Company	30.43
Net proceeds from the Fresh Issue after deducting the Offer related expenses to be borne by our Company (" <b>Net Proceeds</b> ")	529.57

*(1) To be determined after finalisation of the Offer Price and updated in the Prospectus prior to filing with the RoC.*

### Proposed schedule of implementation and utilization of Net Proceeds

We propose to deploy the Net Proceeds for the aforesaid purposes in accordance with the estimated schedule of implementation and deployment of funds set forth in the table below:

<i>(in ₹ million)</i>				
S. No.	Particulars	Total estimated amount/ expenditure	Amount to be deployed from the Net Proceeds in Fiscal 2022	Amount to be deployed from the Net Proceeds in Fiscal 2023
1.	Funding long-term working capital requirements	450	400	50
2.	General corporate purposes	79.57	79.57	-
	<b>Total Net Proceeds</b>	<b>529.57</b>	<b>479.57</b>	<b>50</b>

In the event of the estimated utilisation of the Net Proceeds in a scheduled Fiscal being not undertaken in its entirety, the remaining Net Proceeds shall be utilised in subsequent Fiscals, as may be decided by our Company, in accordance with applicable laws. If the Net Proceeds are not utilized (in full or in part) for the objects of the Offer during the period stated above due to factors such as (i) economic and business conditions; (ii) the timing of completion of the Offer; (iii) market conditions outside the control of our Company; and (iv) any other business and commercial considerations, the remaining Net Proceeds shall be utilized (in full or in part) in subsequent periods as may be determined by our Company, in accordance with applicable laws.

The fund requirements, the deployment of funds and the intended use of the Net Proceeds as described herein are based on our current business plan, management estimates, and other commercial and technical factors. We may have to revise our funding requirements and deployment on account of a variety of factors such as our financial and market condition, business and strategy, competition and interest or exchange rate fluctuations and other external factors, which may not be within the control of our management. This may entail rescheduling or revising the planned expenditure and funding requirements, including the expenditure for a particular purpose at the discretion of our management.

In case of variations in the actual utilization of funds earmarked for the purposes set forth above, increased fund requirements for a particular purpose may be financed by our internal accruals and/ or debt, as required. If the actual utilisation towards any of the Objects is lower than the proposed deployment such balance will be used for general corporate purposes to the extent that the total amount to be utilised towards general corporate purposes will not exceed 25% of the Gross Proceeds from the Fresh Issue in accordance with the SEBI ICDR Regulations.

## Details of the Objects

### 1. Funding long term working capital requirements

We fund a majority of our working capital requirements in the ordinary course of business from banks and internal accruals. As on March 31, 2021, our Company has total sanctioned limit of working capital facilities of ₹ 3,189.40 million, including fund-based and non-fund based limits. The aggregate amounts sanctioned under the fund based and non-fund based working capital facilities of our Company as on March 31, 2021 are ₹ 2,250.30 million and ₹ 939.10 million, respectively. We propose to utilise ₹ 400 million and ₹ 50 million from the Net Proceeds to fund the long-term working capital requirements of our Company in Fiscal 2022 and 2023, respectively.

#### *Basis of estimation of long-term working capital requirement*

The details of our Company's working capital as at March 31, 2019, March 31, 2020 and March 31, 2021, derived from the Restated Financial Statements, and source of funding of the same are provided in the table below:

(₹ in million)					
Sr. No.	Particulars	Notes	Amount as on March 31, 2019	Amount as on March 31, 2020	Amount as on March 31, 2021
<b>1</b>	<b>Current Assets</b>				
A	Trade Receivables		1,814.96	1,276.72	1,708.01
B	Inventories		1,602.01	1,305.71	1,710.73
C	Other financial and current assets		263.35	347.15	367.55
	<b>Total current assets</b>	<b>(A)</b>	<b>3,680.32</b>	<b>2,929.58</b>	<b>3,786.29</b>
<b>2</b>	<b>Current Liabilities</b>				
A	Trade Payables		912.99	738.47	1,176.35
B	Other financial and current liabilities		177.65	70.75	195.52
	<b>Total current liabilities</b>	<b>(B)</b>	<b>1,090.64</b>	<b>809.22</b>	<b>1,371.87</b>
<b>3</b>	<b>Net working capital requirements</b>	<b>(C) = (A) - (B)</b>	<b>2,589.68</b>	<b>2,120.36</b>	<b>2,414.42</b>
<b>4</b>	<b>Existing funding pattern</b>				
	Borrowings from banks, financial institutions and non-banking financial companies (including bill discounting)		2,368.78	1,940.60	1,835.72
	Internal accruals / Equity		220.90	179.76	578.70
	<b>Total</b>		<b>2,589.68</b>	<b>2,120.36</b>	<b>2,414.42</b>

*Note: Pursuant to the certificate dated July 18, 2021, issued by Bhatt & Associates, Chartered Accountants.*

On the basis of our existing working capital requirements and the projected working capital requirements, our Board, pursuant to their resolutions dated July 18, 2021, has approved the business plan for the Fiscal 2022 and 2023, and the projected working capital requirements for Fiscal 2022 and 2023 as stated below:

(₹ in million)				
S. no	Particulars	Notes	Estimated Amount as on March 31, 2022	Estimated Amount as on March 31, 2023
<b>1</b>	<b>Current Assets</b>			
a	Trade Receivables		1,917.81	2,205.48
b	Inventories		1,972.60	2,205.48
c	Other financial and current assets		547.95	567.12
	<b>Total current assets</b>	<b>(A)</b>	<b>4,438.36</b>	<b>4,978.08</b>
<b>2</b>	<b>Current Liabilities</b>			
a	Trade Payables		1,232.88	1,417.81
b	Other financial and current liabilities		191.78	220.55
	<b>Total current liabilities</b>	<b>(B)</b>	<b>1,424.66</b>	<b>1,638.36</b>
<b>3</b>	<b>Net working capital requirements</b>	<b>(C) = (A) - (B)</b>	<b>3,013.70</b>	<b>3,339.73</b>
<b>4</b>	<b>Source of finance</b>			
	Proceeds from the Offer		400.00	450.00
	Borrowings from banks, financial institutions and non-banking financial companies (including bill discounting) or internal accruals		2,613.70	2,889.73
	<b>Total source of finance</b>		<b>3,013.70</b>	<b>3,339.73</b>

*Note: Pursuant to the certificate dated July 18, 2021, issued by Bhatt & Associates, Chartered Accountants*

Our Statutory Auditors have provided no assurance on the prospective financial information, working capital estimates or projections and have performed no services with respect to it.

Our Company proposes to utilize ₹ 450 million from the Net Proceeds towards funding the long-term working capital requirements of the Company.

The table below contains the details of the holding levels (in number of days or relevant matrix as applicable) considered and is derived from the Restated Financial Statements for Fiscal 2019, Fiscal 2020 and Fiscal 2021, the projections for Fiscal 2022 and Fiscal 2023, and the assumptions based on which the working plan projections has been made and approved by our Board of Directors:

Sr. No.	Particulars	Number of days for the Fiscal ended				
		March 31, 2019	March 31, 2020	March 31, 2021	March 31, 2022	March 31, 2023
1.	Trade receivables	73	70	101	70	70
2.	Inventories	65	72	101	72	70
3.	Other financial and current assets	11	19	22	20	18
4.	Trade payables	37	40	70	45	45
5.	Other financial and current liabilities	7	4	12	7	7

*Note: Pursuant to the certificate dated July 18, 2021, issued by Bhatt & Associates, Chartered Accountants*

Key assumptions for working capital projections made by our Company:

S No.	Particulars	Assumptions
<b>Current Assets</b>		
1.	Trade receivables	Historically, the holding levels of trade receivables have ranged from 70-101 days in last three Fiscals. We believe that the levels of trade receivables in Fiscal 2021 were elevated

		owing to back-ended recovery and will normalize in Fiscal 2022 and Fiscal 2023. In light of the same, we have assumed receivables of 70 days each for Fiscal 2022 and Fiscal 2023
2.	Inventories	Inventory levels tend to be dependent upon delivery schedules and over the last three Fiscals have ranged between 65-101 days. We believe that the levels of inventories in Fiscal 2021 were elevated owing to back-ended recovery and will normalize in Fiscal 2022 and Fiscal 2023. In light of the same, we have assumed inventories of 72 days for Fiscal 2022 and 70 days for Fiscal 2023
3.	Other financial and current assets	The key items under this head are balance with statutory/ government authorities, advances, export incentives which are yet to be received etc. We have assumed levels of 20 days for Fiscal 2022 and 18 days for Fiscal 2023 which is closer to trends in Fiscal 2020
<b>Current Liabilities</b>		
4.	Trade payables	Over the past three years, our trade payables have varied between 37 days and 70 days. We believe that back-ended recovery had led to elevated levels of trade payables in Fiscal 2021 and have thus assumed 45 days each for Fiscal 2022 and Fiscal 2023
5.	Other current liabilities & Provisions	Holding levels under this head has ranged from 4-12 days in the last three Fiscals. We have projected this at around 7 days each for Fiscal 2022 and Fiscal 2023

*Note: Pursuant to the certificate dated July 18, 2021, issued by Bhatt & Associates, Chartered Accountants*

The aforementioned working capital estimates and projections have been approved by the Board through their resolution dated July 18, 2021.

Our Company proposes to utilize ₹ 400 million and ₹ 50 million of the Net Proceeds in Fiscal 2022 and Fiscal 2023, respectively, towards our long term working capital requirements. The balance portion of our long term working capital requirement will be arranged from existing equity, internal accruals and borrowings from banks.

## **2. General Corporate Purposes**

Our Company proposes to deploy the balance Net Proceeds aggregating to ₹ 79.57 million towards general corporate purposes, subject to such amount not exceeding 25% of the Gross Proceeds, in compliance with the SEBI ICDR Regulations. The general corporate purposes for which our Company proposes to utilise Net Proceeds include strategic initiatives and acquisitions and meeting exigencies, strengthening our marketing capabilities, towards repayment and pre-payment of loans, meeting expenses incurred by our Company and strengthening of our manufacturing and R&D capabilities, as may be decided by our Company. The Company has received consent from all of its lenders for the Offer.

In addition to the above, our Company may utilise the Net Proceeds towards other expenditure considered expedient and as approved periodically by our Board or a duly constituted committee thereof, subject to compliance with necessary provisions of the Companies Act. The quantum of utilisation of funds towards each of the above purposes will be determined by our Board, based on the amount actually available under this head and the business requirements of our Company, from time to time. Our Company's management shall have flexibility in utilising surplus amounts, if any.

### **Appraisal of the Objects and Bridge Financing**

The objects of the Fresh Issue have not been appraised by any bank, financial institution or agency and we have not raised any bridge loans against the Net Proceeds.

### **Means of Finance**

The entire requirements of the objects detailed above are intended to be funded from the Net Proceeds. Accordingly, we confirm that there is no need for us to make firm arrangements of finance through verifiable means towards at least 75% of the stated means of finance, excluding the amount to be raised through the Offer.

### **Offer related expenses**

The total expenses of the Offer are estimated to be approximately ₹ 402.16 million.

The Offer related expenses primarily include fees payable to the BRLMs and legal counsels, fees payable to the Auditors, brokerage and selling commission, underwriting commission, commission payable to Registered Brokers, RTAs, CDPs, SCSBs' fees, Sponsor Bank's fees, Registrar's fees, printing and stationery expenses, advertising and marketing expenses and all other incidental and miscellaneous expenses for listing the Equity Shares on the Stock Exchanges.

Other than (i) the listing fees, and (ii) stamp duty on issuance of Equity Shares, which will be solely borne by our Company, and the stamp duty payable on transfer of Equity Shares and securities transaction tax which will be solely borne by the Selling Shareholder (i.e. Rivendell PE LLC), all costs, charges, fees and expenses that are associated with and incurred in connection with the Offer including, inter-alia, filing fees, book building fees and other charges, fees and expenses of SEBI, the Stock Exchanges, the Registrar of Companies and any other Governmental Authority, advertising, printing, road show expenses, fees and expenses of the legal counsel to the Offer, fees and expenses of the statutory auditors, registrar fees and broker fees (including fees for procuring of applications), bank charges, fees and expenses of the BRLMs, syndicate members, Self- Certified Syndicate Banks, other Designated Intermediaries and any other consultant, advisor or third party in connection with the Offer shall be borne by the Company and the Selling Shareholder (i.e. Rivendell PE LLC) in proportion to the number of Equity Shares issued and Allotted by the Company pursuant to the Fresh Issue and transferred by the Selling Shareholder (i.e. Rivendell PE LLC) pursuant to the Offer for Sale. All the expenses relating to the Offer shall be paid by the Company in the first instance. Upon commencement of listing and trading of the Equity Shares on the Stock Exchanges pursuant to the Offer, the Selling Shareholder (i.e. Rivendell PE LLC) shall reimburse the Company for any expenses in relation to the Offer paid by the Company on behalf of the Selling Shareholder (i.e. Rivendell PE LLC) directly from the Public Offer Account. However, in the event that the Offer is withdrawn by our Company or not completed for any reason whatsoever, all the Offer related expenses will be borne in a proportionate manner between our Company and the Selling Shareholder.

The estimated Offer related expenses are as follows:

<i>(₹ in million)</i>				
S. No	Activity	Estimated amount <sup>(1)</sup> (₹ in million)	As a % of total estimated Offer Expenses <sup>(1)</sup>	As a % of Offer Size <sup>(1)</sup>
1.	BRLMs fees and commissions (including underwriting commission)	232.90	57.91%	3.19%
2.	Brokerage, selling commission, bidding charges, processing fees and bidding charges for the Members of the Syndicate, Registered Brokers, SCSBs, RTAs and CDPs <sup>(2)(3)(4)(5)(6)</sup>	43.74	10.88%	0.60%
3.	Fees payable to the Registrar to the Issue	0.23	0.06%	0.00%
4.	Other expenses			
	(i) Legal advisors	6.49	1.61%	0.09%
	(ii) Listing fees, SEBI filing fees, book building software fees, and other regulatory expenses including expenses towards Stock Exchanges;	40.82	10.15%	0.56%
	(iii) Printing and despatch of issue stationery expenses	21.82	5.43%	0.30%
	(iv) Advertising and marketing expenses for the issue	18.16	4.52%	0.25%
	(v) Miscellaneous	38.00	9.45%	0.52%
	<b>Total Estimated Offer Expenses</b>	<b>402.16</b>	<b>100.00%</b>	<b>5.50%</b>

<sup>(1)</sup> Amounts will be finalised and incorporated in the Prospectus on determination of Offer Price.

<sup>(2)</sup> Selling commission payable to the SCSBs on the portion for Retail Individual Bidders and Non-Institutional Bidders, which are directly procured and uploaded by the SCSBs, would be as follows:

Portion for Retail Individual Bidders*	0.35% of the Amount Allotted* (plus applicable taxes)
Portion for Non-Institutional Bidders*	0.20% of the Amount Allotted* (plus applicable taxes)

\*Amount Allotted is the product of the number of Equity Shares Allotted and the Offer Price

No additional uploading/ processing fees shall be payable by our Company and the Selling Shareholder (i.e. Rivendell PE LLC) to the SCSBs on the applications directly procured by them.

<sup>(3)</sup> Processing fees payable to the SCSBs on the portion for Retail Individual Bidders and Non-Institutional Bidders which are procured by the members of the Syndicate/sub-Syndicate/Registered Broker/RTAs/ CDPs and submitted to SCSB for blocking, would be as follows:

Portion for Retail Individual Bidders	₹10 per valid application (plus applicable taxes)
Portion for Non-Institutional Bidders	₹10 per valid application (plus applicable taxes)

(4) *The Processing fees for applications made by Retail Individual Bidders using the UPI Mechanism would be as follows:*

<i>Members of the Syndicate / RTAs / CDPs</i>	<i>₹10 per valid application (plus applicable taxes)</i>
<i>Sponsor Bank</i>	<i>₹ 1 per valid Bid cum Application Form* (plus applicable taxes) The Sponsor Bank shall be responsible for making payments to the third parties such as remitter bank, NCPI and such other parties as required in connection with the performance of its duties under the SEBI circulars, the Syndicate Agreement and other applicable laws.</i>

*\*Per mandate created*

(5) *Selling commission on the portion for Retail Individual Bidders and Non-Institutional Bidders which are procured by members of the Syndicate (including their sub-Syndicate Members), Registered Brokers, RTAs and CDPs would be as follows:*

<i>Portion for Retail Individual Bidders</i>	<i>0.35% of the Amount Allotted* (plus applicable taxes)</i>
<i>Portion for Non-Institutional Bidders</i>	<i>0.20% of the Amount Allotted* (plus applicable taxes)</i>

*\*Amount Allotted is the product of the number of Equity Shares Allotted and the Offer Price*

(6) *Bidding charges of ₹ 10 (plus applicable taxes) shall be paid per valid Bid cum Application Form collected by the Syndicate, RTAs and CDPs (excluding applications made by Retail Individual Investors using the UPI mechanism). The terminal from which the Bid has been uploaded will be taken into account in order to determine the total bidding charges. No additional bidding charges shall be payable to SCSBs on the Bid cum Application Forms directly procured and bid by them.*

(7) *Selling commission payable to the Registered Brokers on the portion for Retail Individual Investors and, Non-Institutional Investors which are directly procured by the Registered Brokers and submitted to SCSB for processing, shall be ₹ 10 per valid Bid cum Application Form (plus applicable taxes).*

*The Selling Commission payable to the Syndicate / Sub-Syndicate Members will be determined on the basis of the application form number / series, provided that the application is also bid by the respective Syndicate / Sub-Syndicate Member. For clarification, if a Syndicate ASBA application on the application form number / series of a Syndicate / Sub-Syndicate Member, is bid by an SCSB, the Selling Commission will be payable to the SCSB and not the Syndicate / Sub-Syndicate Member. The selling commission and bidding charges payable to Registered Brokers the RTAs and CDPs will be determined on the basis of the bidding terminal ID as captured in the bid book of BSE or NSE.*

*In addition to the selling commission referred above, any additional amount(s) to be paid by our Company and Selling Shareholder (i.e. Rivendell PE LLC) shall be as mutually agreed amongst the Book Running Lead Manager, their respective Syndicate Members, our Company and Selling Shareholder (i.e. Rivendell PE LLC) before the opening of the Issue.*

## **Monitoring of Utilisation of Funds**

Since the size of the proposed Fresh Issue is less than ₹ 1,000.00 million, our Company shall not be required to appoint a monitoring agency to monitor Utilisation of the Net Proceeds, in accordance with Regulation 41 of the SEBI ICDR Regulations.

## **Interim use of Net Proceeds**

Pending utilization of the Net Proceeds for the purposes described above, our Company undertakes to deposit the Net Proceeds only in one or more scheduled commercial banks included in the Second Schedule of the Reserve Bank of India Act, 1934, as amended, as may be approved by our Board or the IPO Committee.

In accordance with Section 27 of the Companies Act, 2013, our Company confirms that it shall not use the Net Proceeds for buying, trading or otherwise dealing in shares of any other listed company or for any investment in the equity markets.

## **Other Confirmations**

Except for payments made to our Promoter, members of the Promoter Group, our Directors or our Key Managerial Personnel in the normal course of business and in compliance with applicable law, no part of the Net Proceeds will be paid by our Company as consideration to our Promoter, members of the Promoter Group, our Directors or our Key Managerial Personnel.

Subject to the forgoing, our Company has not entered into and is not planning to enter into any arrangement/ agreements with our Promoter, Directors, or Key Managerial Personnel in relation to the utilisation of the Net Proceeds. Further, there are no existing or anticipated interest of such individuals and entities in the objects of the Offer except as set out above.

## **Variation in Objects**



In accordance with Sections 13(8) and 27 of the Companies Act, 2013 and the applicable rules, and the SEBI ICDR Regulations, our Company shall not vary the objects of the Fresh Issue without our Company being authorised to do so by the Shareholders by way of a special resolution. In addition, the notice issued to the Shareholders in relation to the passing of such special resolution (“**Notice**”) shall specify the prescribed details as required under the Companies Act. The Notice shall simultaneously be published in the newspapers, one in English and one in Gujarati, the vernacular language of the jurisdiction where our Registered Office is situated. Our Promoters will be required to provide an exit opportunity to such Shareholders who do not agree to the above stated proposal, at a price as prescribed by SEBI, in this regard.

## BASIS FOR OFFER PRICE

The Offer Price have been determined by our Company and the Selling Shareholder (i.e. Rivendell PE LLC), in consultation with the BRLMs on the basis of assessment of market demand for the Equity Shares offered in the Offer through the Book Building Process and on the basis of the qualitative and quantitative factors as described below. The face value of the Equity Shares is ₹10 each and the Offer Price is 88.0 times the face value at the lower end of the Price Band and 90.0 times the face value at the higher end of the Price Band. Investors should also refer to the sections “Our Business”, “Risk Factors”, “Financial Statements” and “Management Discussion and Analysis” on pages 111, 22, 161 and 224 respectively, to have an informed view before making an investment decision.

### Qualitative Factors

Some of the qualitative factors and our strengths which form the basis for computing the Offer Price are:

- Comprehensive product portfolio
- Manufacturing capabilities which offer scale, flexibility and locational advantage
- Long standing customer relationships and geographically diversified revenue base
- Experienced Promoters and management team with strong domain expertise
- Strong financial performance over the past three years

For further details, please see “Our Business – Strength” on page 112.

### Quantitative factors

Some of the information presented in this section relating to our Company is derived from the Restated Financial Statements. For details, see “Financial Statements” beginning on page 161.

Some of the quantitative factors, which may form the basis for computing the Offer Price, are as follows:

#### 1. Basic and Diluted Earnings Per Equity Share (“EPS”)<sup>(1) (2)</sup>, as per restated financial statement

Financial Period	Basic EPS (in ₹)	Diluted EPS, (in ₹)	Weights
Financial Year ended March 31, 2021	36.26	35.96	3
Financial Year ended March 31, 2020	22.08	22.08	2
Financial Year ended March 31, 2019	24.62	24.62	1
<b>Weighted Average</b>	<b>29.59</b>	<b>29.44</b>	

<sup>(1)</sup> Basic EPS (₹) = Basic earnings per share are calculated by dividing the net restated profit or loss for the year attributable to equity shareholders by the weighted average number of Equity Shares outstanding during the year.

<sup>(2)</sup> Diluted EPS (₹) = Diluted earnings per share are calculated by dividing the net restated profit or loss for the year attributable to equity shareholders by the weighted average number of Equity Shares outstanding during the year as adjusted for the effects of all dilutive potential Equity Shares outstanding during the year.

<sup>(3)</sup> Basic EPS considered for Financial Year ended March 31, 2021 does not take into consideration the conversion of the OCRPS, which were converted on July 16, 2021.

### Notes

1. Basic EPS and Diluted EPS calculations are in accordance with Indian Accounting Standard 33 'Earnings per Share'.
2. Weighted average number of Equity Shares is the number of Equity Shares outstanding at the beginning of the period adjusted by the number of Equity Shares issued during the period multiplied by the time weighting factor. The time weighting factor is the number of days for which the specific shares are outstanding as a proportion of total number of days during the period.

3. *Weighted average = Aggregate of year-wise weighted EPS divided by the aggregate of weights i.e. [(EPS x Weight) for each year] / [Total of weights]*
4. *The above statement should be read with significant accounting policies and notes on Restated Financial Statements as appearing in the section titled “Financial Statements” on page 161.*

**2. Price Earning (“P/E”) Ratio in relation to the Price Band of ₹ 880 to ₹ 900 per Equity Share**

Particulars	P/E ratio at the lower end of the Price Band (number of times)	P/E ratio at the higher end of the Price Band (number of times)
Based on Basic EPS for the financial year ended March 31, 2021	24.27	24.82
Based on Diluted EPS for the financial year ended March 31, 2021	24.47	25.03

**Industry Peer Group P/E ratio**

Particulars	Name of the Company	P/E Ratio	Face value of equity shares (in ₹)
Highest	Ramkrishna Forgings Ltd	116.39	10
Lowest	MM Forgings Ltd	38.64	10
Industry Composite	-	77.52	-

Notes:

1. *The highest and lowest industry P/E shown above is based on the peer set provided below under “Comparison with listed industry peers”. The industry average has been calculated as the arithmetic average P/E of the peer set provided below.*
2. *P/E figures for the peer are computed based on closing market price as on July 15, 2021 on BSE, divided by Basic EPS (on consolidated basis) for the Financial Year ending March 31, 2021.*

**3. Return on Net Worth (RoNW)**

Financial Period	RoNW, as derived from the Restated Financial Statements (%)	Weights
Financial Year ended March 31, 2021	24.38	3
Financial Year ended March 31, 2020	19.75	2
Financial Year ended March 31, 2019	27.42	1
<b>Weighted Average</b>	<b>23.34</b>	

- (1) *Return on Net Worth (%) = Restated Profit for the year divided by Total Equity at the end of the year.*
- (2) *Total Equity has been computed as the aggregate of equity share capital and other equity.*
- (3) *Weighted average number of Equity Shares is the number of Equity Shares outstanding at the beginning of the year adjusted by the number of Equity Shares issued during the year multiplied by the time weighting factor. The time weighting factor is the number of days for which the specific shares are outstanding as a proportion of total number of days during the year.*
- (4) *Weighted average = Aggregate of year-wise weighted EPS divided by the aggregate of weights i.e. [(EPS x Weight) for each year] / [Total of weights]*

#### 4. Net Asset Value per Equity Share

Fiscal Ended	NAV derived from the Restated Financial Statements (₹)
As on March 31, 2021 <sup>(4)</sup>	148.76
After the completion of the Offer* At the Floor Price:	151.48
At the Cap Price:	151.55
Offer Price*	900

\*Not derived from the Restated Financial Statements.

#### Notes:

- (1) Offer Price per Equity Share has been determined on conclusion of the Book Building Process.
- (2) Net Asset Value Per Equity Share = Total Equity as per the Restated Financial Statements / number of equity shares outstanding as at the end of year
- (3) Total Equity has been computed by aggregating equity share capital and other equity
- (4) This calculation does not take into account conversion of OCRPS which converted on July 16, 2021.

#### 5. Comparison of Accounting Ratios with Listed Industry Peers

Name of the company	Total Income (₹ in million)	Face Value (₹)	P/E	EPS (Basic) (₹)	EPS (Diluted)(₹)	RoNW (%)	NAV per equity share (₹)
Rolex Rings Limited*	6,197.57	10	25.03	36.26	35.96	24.38%	148.76
Listed Peers							
Bharat Forge Ltd	65,051.59	2.00	NM <sup>#</sup>	(2.71)	(2.71)	NM <sup>#</sup>	112.11
Ramkrishna Forgings Ltd	12,945.22	10.00	116.39	6.44	6.44	2.3%	276.00
MM Forgings Ltd	7,618.29	10.00	38.64	19.35	19.35	9.6%	201.80

\*Financial information for Rolex Rings Limited is derived from the Restated Financial Statements for the year ended March 31, 2021; <sup>#</sup> Not meaningful as the company has incurred losses

1. All the financial information for listed industry peers mentioned above is on a consolidated basis and is sourced from the annual reports as available of the respective company for the year ended March 31, 2021.
2. P/E ratio is calculated as closing share price (as of July 15, 2021 - BSE) divided by Diluted EPS for year ended March 31, 2021.
3. Basic and Diluted EPS as reported in the annual report of the company for the year ended March 31, 2021.
4. Return on net worth (%) = Net profit/(loss) after tax attributable to equity shareholders divided total equity net of minority interest
5. Net asset value per share (in ₹) = Total equity net of minority interest divided by Total number of equity shares outstanding at the end of the year.
6. Total Equity has been computed as sum of paid-up share capital and other equity.

#### The Offer Price is 90 times of the face value of the Equity Shares.

The Offer Price of ₹ 900 has been determined by our Company and the Selling Shareholder (i.e. Rivendell PE LLC) in consultation with the BRLMs, on the basis of assessment of demand from investors for Equity Shares through the Book Building Process and, is justified in view of the above qualitative and quantitative parameters.

Investors should read the above-mentioned information along with “Risk Factors”, “Our Business”, “Financial Statements” and “Management’s Discussion and Analysis of Financial Condition and Results of Operations” on pages 22, 111, 161 and 224, respectively, to have a more informed view. The trading price of the Equity Shares could decline due to the factors mentioned in the “Risk Factors” beginning on page 22 and you may lose all or part of your investments.

## STATEMENT OF TAX BENEFITS

### STATEMENT OF SPECIAL TAX BENEFITS AVAILABLE TO ROLEX RINGS LIMITED AND ITS SHAREHOLDERS UNDER THE APPLICABLE LAWS IN INDIA

The Board of Directors  
Rolex Rings Limited  
Gondal Road, Village Kotharia  
Rajkot – 360004,  
Gujarat, India.

Dear Sirs / Madams,

#### **Statement of Special Tax Benefits available to Rolex Rings Limited and its shareholders under the Indian tax laws.**

We hereby confirm that the enclosed Annexure 1 & 2 (together the “Annexures”), prepared by Rolex Rings Limited (formerly known as Rolex Rings Private Limited), (hereinafter referred as the ‘Company’), provides the special tax benefits available to the Company and to the shareholders of the Company under the:

- Income-tax Act, 1961 (the “Act”) as amended by the Finance Act 2021, i.e. applicable for the Financial Year 2021-22 relevant to the assessment year 2022-23, presently in force in India;
- the Central Goods and Services Tax Act, 2017 / the Integrated Goods and Services Tax Act, 2017 and applicable State Goods and Services Tax Act, 2017 (“GST Acts”), the Customs Act, 1962 (“Customs Act”) and the Customs Tariff Act, 1975 (“Tariff Act”) as amended by the Finance Act 2021, i.e., applicable for the Financial Year 2021-22 relevant to the assessment year 2022-23, presently in force in India

The Act, the GST Acts, the Customs Act and the Tariff Act as defined above, are collectively referred to as the “Tax Laws”.

This statement can be included in the (i) red herring prospectus proposed to be filed with the Securities and Exchange Board of India (“SEBI”), BSE Limited and National Stock Exchange of India Limited (collectively, the “Stock Exchanges”); (ii) red herring prospectus proposed to be filed with SEBI, the Stock Exchanges and the Registrar of Companies, Gujarat, Dadra and Nagar Haveli, located at Ahmedabad (“Registrar of Companies”); and (iii) prospectus proposed to be filed with SEBI, the Stock Exchanges and the Registrar of Companies for the proposed initial public offer through a fresh issuance of equity shares of face value Rs 10 each, of the Company; and offer for sale by the certain selling shareholders of the Company (the “Offer”), as required under the provisions of the Securities and Exchange Board of India (Issue of Capital and Disclosure Requirements) Regulations, 2018, as amended. Several of these benefits are dependent on the Company or its shareholders fulfilling the conditions prescribed under the relevant provisions of the Act. Hence, the ability of the Company and / or its shareholders to derive the special tax benefits is dependent upon their fulfilling such conditions which, based on business imperatives the Company faces in the future, the Company or its shareholders may or may not choose to fulfil.

1. The benefits discussed in the enclosed Annexures are not exhaustive and the preparation of the contents stated is the responsibility of the Company’s management. We are informed that this statement is only intended to provide general information to the investors and is neither designed nor intended to be a substitute for professional tax advice. In view of the individual nature of the tax consequences and the changing tax laws, each investor is advised to consult his or her own tax consultant with respect to the specific tax implications arising out of their participation in the issue.
2. We do not express any opinion or provide any assurance as to whether:
  - i) the Company or its shareholders will continue to obtain these benefits in future;
  - ii) the conditions prescribed for availing the benefits have been / would be met with; and

- iii) the revenue authorities/courts will concur with the views expressed herein.
3. The contents of the enclosed Annexures are based on information, explanations and representations obtained from the Company and on the basis of their understanding of the business activities and operations of the Company.
  4. This Statement is issued solely in connection with the Offer and is not to be used, referred to or distributed for any other purpose.

S R B C & CO LLP  
Chartered Accountants  
ICAI Firm Registration Number: 324982E/E300003

**per Sukrut Mehta**  
Partner  
Membership Number: 101974  
UDIN: 21101974AAAADK6997

Place of Signature: Ahmedabad  
Date: July 18, 2021

**ANNEXURE 1 TO THE STATEMENT OF SPECIAL TAX BENEFITS AVAILABLE TO THE  
COMPANY AND ITS SHAREHOLDERS UNDER THE APPLICABLE TAX LAWS IN INDIA -  
INCOME-TAX ACT, 1961**

Outlined below are the special tax benefits available to Rolex Rings Limited (the “Company”) and its Shareholders under the Income-tax Act, 1961 (the “Act”) as amended by the Finance Act, 2021 applicable for the Financial Year 2021-22 relevant to the Assessment Year 2022-23, presently in force in India.

**1. Special tax benefits available to the Company under the Act**

**A. MAT Credit carried forward to subsequent assessment years – Provisions of Section 115JAA of the Act**

Under the provisions of the Act, the company has to pay higher of normal tax liability or liability as per MAT provisions. If in any year the company pays liability as per MAT, then it is entitled to claim credit of MAT paid over and above the normal tax liability in the subsequent years.

Further Section 115JAA of the Act states that MAT credit can be utilised by the company in the subsequent years and can be adjusted in the year in which the liability of the company as per the normal provisions is more than the MAT liability. The set off in respect of brought forward MAT credit shall be allowed in the subsequent years to the extent of the difference between the tax on its total income as per the normal provisions of the Act and as per the MAT provisions.

The company can carry forward the MAT credit for adjustment in subsequent years for a period of 15 years after which it will get lapsed.

The company has represented that they have paid taxes under MAT provisions in the previous years and hence have MAT credit which is eligible for set off in the subsequent years as per the provisions of the Act. The aforesaid benefit is available till such MAT credit is entirely utilised within 15 years or the Company opts for new tax regime under section 115BAA of the Act.

**B. Additional depreciation – Provisions of Section 32 of the Act**

Subject to the specified conditions under Section 32(1)(iia) of the Act, assessee engaged in the business of manufacture or production of any article or thing or in the business of generation, transmission or distribution of power is allowed additional depreciation at the rate of 20% on any new plant and machinery installed after 31 March 2005.

The company has represented that they are eligible for claim of additional depreciation on new plant and machinery as per the provisions of the Act

**C. Section 80M**

Up to 31 March 2020, any dividend paid to a shareholder by a company was liable to Dividend Distribution Tax (‘DDT’), and the recipient shareholder was exempt from tax. Pursuant to the amendment made by the Finance Act 2020, DDT stands abolished and the dividend received by a shareholder on or after 1 April 2020 would be liable to tax in hands of the shareholder. The company distributing such dividends is required to deduct taxes at source (‘TDS’) at applicable rate specified under the Act read with the applicable Double Taxation Avoidance Agreement (if any).

For the resident company distributing dividends, a new section 80M was inserted by the Finance Act, 2020 with effect from 1 April 2020 providing for deduction from gross total income of a domestic company, of an amount equal to dividends received by such company from another domestic company or a foreign company or a business trust as does not exceed the amount of dividend distributed by it on or before one month prior to the date of filing its tax return (‘Due Date’) as prescribed under section 139(1) of the Act.

Where the Company receives any such dividend during a Financial Year and also, distributes dividend to its shareholders before the aforesaid Due Date, as may be relevant to the said Financial Year, it shall be entitled to the deduction under section 80M of the Act.

## **2. Special tax benefits available to Shareholders**

There are no special tax benefits available to the shareholders of the Company for investing in the shares of the company.

### **NOTES:**

1. This Annexure sets out only the tax benefits available to the company and the shareholders under the current Income Tax Act, 1961 i.e the Act as amended by the Finance Act, 2021 applicable for Financial year 2021-22 relevant to the Assessment year 2022-23, presently in force in India.
2. This Annexure covers only certain relevant direct tax law benefits and does not cover any indirect tax law benefits or benefit under any other law.
3. No assurance is given that the revenue authorities/courts will concur with the views expressed herein. Our views are based on the existing provisions of law and its interpretation, which are subject to changes from time to time. We do not assume responsibility to update the views consequent to such changes. We shall not be liable to any claims, liabilities or expenses relating to this assignment except to the extent of fees relating to this assignment, as finally judicially determined to have resulted primarily from bad faith or intentional misconduct. We will not be liable to any other person in respect of this statement.
4. The above statement covers only certain special tax benefits under the Act, read with the relevant rules, circulars and notifications and does not cover any benefit under any other law in force in India. This statement also does not discuss any tax consequences, in the country outside India, of an investment in the shares of an Indian company.
5. The above statement of special tax benefits is as per the current direct tax laws relevant for the assessment year 2022-23. Several of these benefits are dependent on the Company or its shareholders fulfilling the conditions prescribed under the relevant provisions of the Tax Laws.

For Rolex Rings Limited

---

Chief Financial Officer  
Place: Rajkot  
Date: July 18, 2021



**ANNEXURE 2 TO THE STATEMENT OF SPECIAL TAX BENEFITS AVAILABLE TO THE COMPANY  
AND ITS SHAREHOLDERS UNDER THE APPLICABLE TAX LAWS IN INDIA - OTHERS**

Outlined below are the special tax benefits available to the Company and its Shareholders under the Central Goods and Services Tax Act, 2017 / the Integrated Goods and Services Tax Act, 2017 and applicable State Goods and Services Tax Act, 2017 (“GST Acts”), the Customs Act, 1962 (“Customs Act”) and the Customs Tariff Act, 1975 (“Tariff Act”), as amended by the Finance Act 2021 applicable for the Financial Year 2021-22 (unless otherwise specified), presently in force in India.

**1. Special indirect tax benefits available to the Company**

There are no special tax benefits available to the Company under GST law and any other laws mentioned above.

**2. Special tax benefits available to Shareholders**

The Shareholders of the Company are not entitled to any special tax benefits under indirect tax laws.

**3. Notes:**

- 3.1 This Annexure sets out only the special tax benefits available to the Company and its Shareholders under the Central Goods and Services Tax Act, 2017 / the Integrated Goods and Services Tax Act, 2017 and applicable State Goods and Services Tax Act, 2017 (“GST Acts”), the Customs Act, 1962 (“Customs Act”) and the Customs Tariff Act, 1975 (“Tariff Act”), as amended by the Finance Act 2021 applicable for the Financial Year 2021-22 (unless otherwise specified), presently in force in India.
- 3.2 This Annexure is only intended to provide general information to the investors and is neither designed nor intended to be a substitute for professional tax advice. In view of the individual nature of the tax consequences, the changing tax laws, each investor is advised to consult his or her own tax consultant with respect to the specific tax implications arising out of their participation in the Proposed IPO
- 3.3 This annexure covers only indirect tax laws benefits and does not cover any income tax law benefits or benefit under any other law.
- 3.4 These comments are based upon the provisions of the specified indirect tax laws, and judicial interpretation thereof prevailing in the country, as on the date of this Annexure
- 3.5 No assurance is given that the revenue authorities/courts will concur with the views expressed herein. Our views are based on the existing provisions of law and its interpretation, which are subject to changes from time to time.

We do not assume responsibility to update the views consequent to such changes.

For Rolex Rings Limited

\_\_\_\_\_  
Chief Financial Officer  
Place: Rajkot  
Date: July 18, 2021

## SECTION IV – ABOUT OUR COMPANY

### INDUSTRY OVERVIEW

*Unless otherwise specified, the information in this section has been derived from the report titled “Indian bearings industry – Industry revenue to witness a smart recovery in FY 2022” prepared by ICRA Limited (“ICRA Report”). Further, certain information in this section has been extracted from publicly available documents from various sources, including officially prepared materials from the Government and international non-profit organisations. The information has not been independently verified by us, the Book Running Lead Managers, or any of our or its affiliates or advisors. The information may not be consistent with other information compiled by third parties within or outside India. The data may have been re-classified by us for the purposes of presentation. Industry sources and publications generally state that the information contained therein has been obtained from sources generally believed to be reliable, but that their accuracy, completeness and underlying assumptions are not guaranteed and their reliability cannot be assured. Industry sources and publications are also prepared based on information as of specific dates and may no longer be current or reflect current trends. Industry sources and publications may also base their information on estimates, projections, forecasts and assumptions that may prove to be incorrect. Accordingly, investors should not place undue reliance on, or base their investment decision on this information. The information in this section should be read in conjunction with the sections titled “Risk Factors” and “Our Business” on page 22 and 111, respectively.*

### MACROECONOMIC OVERVIEW OF THE GLOBAL ECONOMY

After an estimated 3.5 percent contraction in 2020, the global economy is projected to grow 5.5 percent in 2021 and 4.2 percent in 2022. This reflects a stronger than expected recovery on average across regions in the second half of the year, reflecting additional policy support in a few large economies and expectations of a vaccine-powered strengthening of activity later in the year, which outweigh the drag on near-term momentum due to rising infections. (Source: IMF Update)

#### IMF estimates of GDP growth for key economies

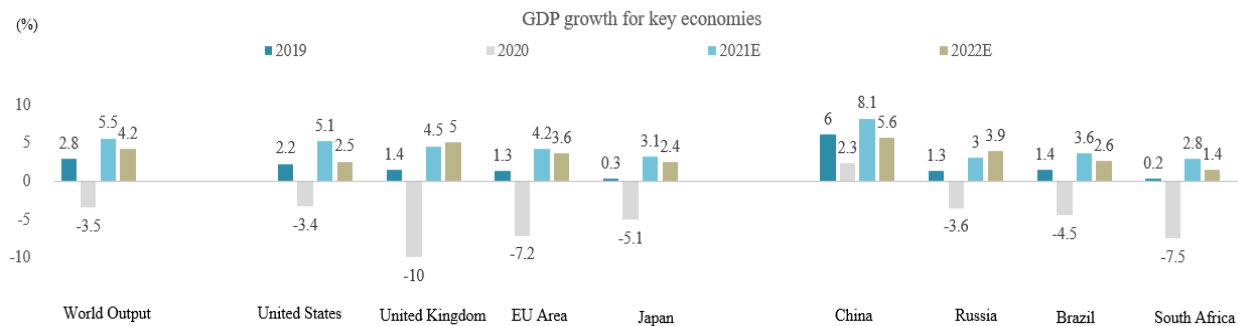

\* EU Area includes Germany, France, Italy, Spain

Source : IMF Update

The sizable fiscal support announced for 2021 in some countries, including most recently in the United States and Japan, together with the unlocking of Next Generation EU funds, will help lift economic activity among advanced economies with favorable spillovers to trading partners. Multiple vaccine approvals and the launch of vaccination in some countries in December 2020 have raised hopes of an eventual end to the pandemic.

Major central banks are assumed to maintain their current policy rate settings throughout the forecast horizon to the end of 2022. As a result, financial conditions are expected to remain broadly at current levels for advanced economies while gradually improving for emerging market and developing economies.

## MACROECONOMIC OVERVIEW OF THE INDIAN ECONOMY

After an expected 7.8% pandemic driven contraction in the ongoing fiscal, India's real GDP is projected to record an expansion of 10.1% in Fiscal 2022, led by the continued normalization in economic activities as the rollout of Covid-19 vaccines gather traction, as well as the low base. ICRA expects a multi-speed recovery in Fiscal 2022, with the contact-intensive sectors, discretionary consumption and investment by the private sector. Nominal GDP is expected to expand by 14.0% in Fiscal 2022, the highest in the current series.

### Growth of GDP (at constant 2011-12 prices)

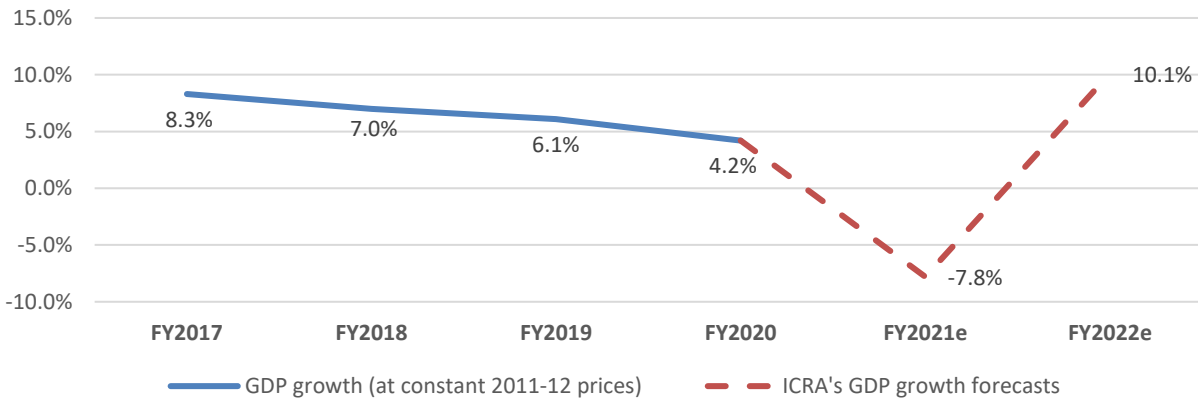

### Share of GFCF (as % of GDP)

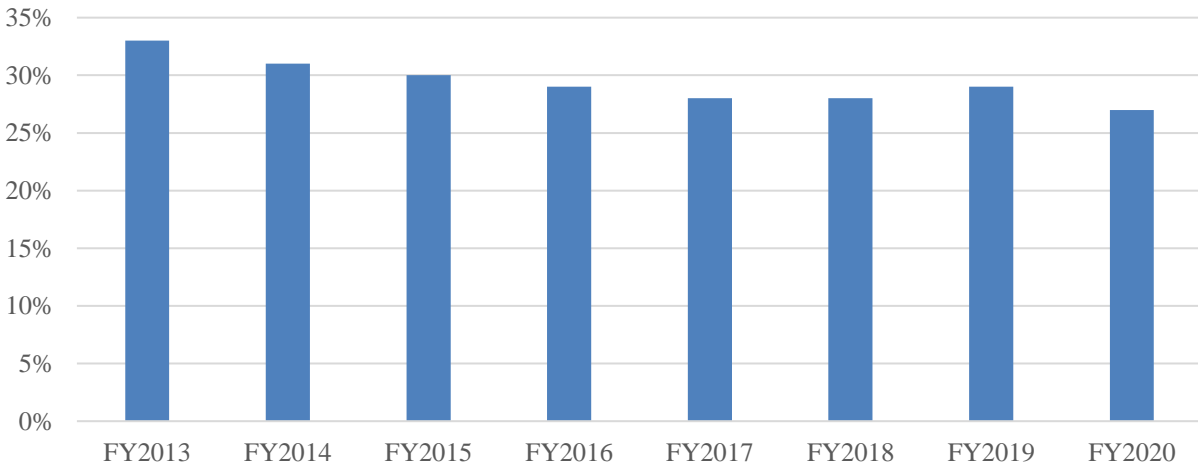

Source: Ministry of Statistics & Planning; ICRA Report

Among the consumer-oriented sectors, the demand in several sectors, including passenger vehicles, two-wheelers, consumer durables etc bounced back significantly in Q3FY2021. Among the commodity-oriented sectors, cement, iron & steel and metals & mining sectors reported sequential and YoY recovery, supported by firming up of commodity prices and volume expansion, aided by the pick-up in industrial and construction activity. Trend in core industries like Cement and Steel, which are expected to return to pre-Covid level in Fiscal 2022. Buoyancy in core segment augurs well for industrial bearing demand, which is also expected to witness handsome growth in coming years.

### GOI plan of providing Performance linked Initiatives to manufacturing sector will make production Attractive in India

The GOI expanded its production linked initiatives to 10 more sectors approving a spend of 1.46 lakh crores over five years to boost manufacturing in India, Enhancing India's Manufacturing Capabilities and Enhancing Exports for a Atmanirbhar Bharat.

Sectors	Approved financial outlay over a five-year period ₹Crore	% of Allotment
Automobiles & Auto Components	57,042	39.1%
Advance Chemistry Cell (ACC) Battery	18,100	12.4%
Pharmaceuticals drugs	15,000	10.3%
Telecom & Networking Products	12,195	8.4%
Food Products	10,900	7.5%
Textile Products: MMF segment and technical textiles	10,683	7.3%
Speciality Steel	6,322	4.3%
White Goods (ACs & LED)	6,238	4.3%
Electronic/Technology Products	5,000	3.4%
High Efficiency Solar PV Modules	4,500	3.1%
<b>Total</b>	<b>145,980</b>	

## GLOBAL BEARINGS MARKET

The global bearing industry size is estimated at USD 50 billion (CY2019), which is dominated by multinational companies like AB SKF (Sweden), Schaeffler Group (Germany), The Timken Company (USA) and Japanese companies like NSK, NTN and JTEKT. SKF is the global market leader in ball bearings which along with five other players (Schaeffler, Timken, NSK, NTN and JTEKT) account for 60% of the global bearings market share.

Among various geographies, Asia accounts for ~50% of the global bearing demand followed by Europe (22%) and Americas (22%). North American countries like the US, Canada and Mexico constitute bulk of the bearing demand in Americas followed by Brazil. The share of Asian countries increased to about 50% of the global bearing demand, up from 30% around a decade ago.

Over the years, China has become the largest automotive market globally, which led to an emergence of Chinese bearings companies on the global platform. Today, China accounts for 30% of the global bearing demand, followed by Japan at 10%. The Chinese bearing market, which remains the largest of the emerging markets, is very fragmented, with the MNCs accounting for about one third of the market while the other two thirds of the market consists of many local manufacturers. Some of the largest players include Wafangdian (ZWZ), Luoyang (LYC), Harbin (HRB), Zhejiang Tianma (TMB), Wanxiang Qianchao, and C&U.

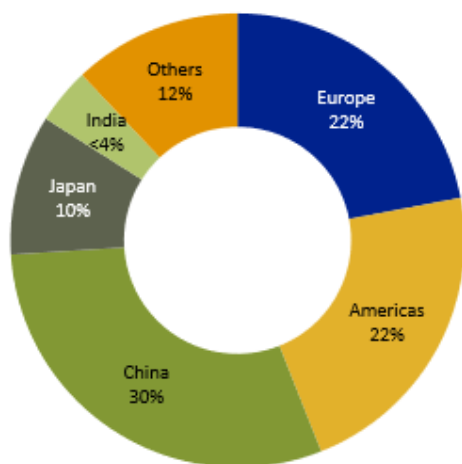

Source: ICRA Report

The Indian bearing industry accounts for less than 4% of the global bearing market, though its share is expected to grow over the medium to long term, supported by increasing industrialisation as well as a healthy growth expected in the automotive market supported by increasing industrialisation as well as a healthy growth expected in the automotive market. The growing demand for industrial equipment and durable goods will contribute to the bearings growth by the OEMs operating in developed markets like the US, Japan and Western Europe. Growing demand for railway equipment, electronics, aircraft and motorcycles in the developing regions will support growth for bearings and related products in the developing markets like China and India.

The market can be broadly classified as the automotive and the industrial segments, with the industrial segment accounting for 61-63% of the overall revenue pie and the automotive segment accounting for the rest. Aftermarket business is an important sub-segment in both the industrial and the automotive segments. Strong presence in the aftermarket sub-segment provides stability to revenues of bearing manufacturers, which are otherwise exposed to cyclicity in the industrial as well as the automotive segments. The aftermarket business accounts for about 36% of the industrial segment revenue and around 21% of the automotive segment revenue for bearing manufacturers.

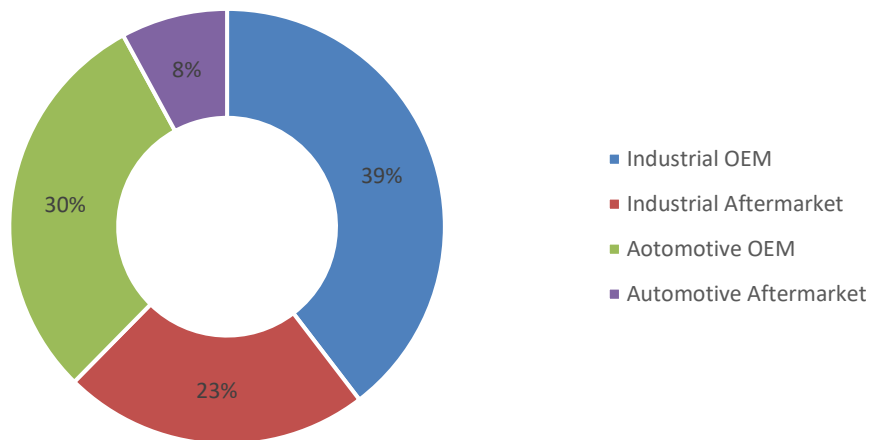

*Source: ICRA Report*

With technological advancements in several industry verticals such as automotive, construction, and oil and gas, the applications and functionalities of bearings are evolving continuously. Over the next few years, the global bearing industry is expected to witness a healthy growth, supported by increasing demand across various application sectors such as automotive, industrial, railways, and aerospace. An increase in automobile production worldwide is augmenting the growth in demand for bearings and associated components. In addition, the need for energy efficiency in process industries has also supported the worldwide demand for bearings significantly. The aerospace equipment segment is the fastest growing application segment in the bearings market

### **INDIAN BEARINGS INDUSTRY**

The Indian bearing market is estimated at ₹ 12,000 crore and it constitutes less than 4% of the global bearing demand. In terms of consumption, about 60% requirement is met through domestic production while the remaining is met through imports. Indian manufacturers do not produce special purpose bearings as demand for the same is low. Special purpose bearings are therefore, imported, as investments for such low-volume SKUs are not financially viable.

Out of 40% imports, the major portion (>70%) is imported by larger suppliers/manufacturers primarily for industrial segments whereas the rest is imported by local manufacturers/traders for the domestic aftermarket. OEMs constitute 60% of demand whereas the rest is driven by aftermarket and exports.

*Break-up of Domestic Production & Imports*

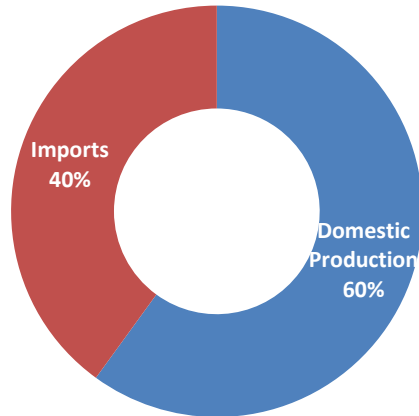

Source : ICRA Report

**Exports account for sizeable chunk of Indian bearing manufacturers**

To capitalise on India’s low-cost labour advantage, global MNCs have also started using the Indian unit as their global sourcing partners. In general, employee expense accounts for ~10% of sales in India compared to ~25% in developed countries, which lends cost advantage for MNCs to set up units in India, if volume of certain SKUs justifies investments. Among the top five OEMs, Timken India derives 25% of its revenue from exports followed by NRB and NEI (at ~20%).

The Indian operations have emerged as the export hub for Timken globally and other Indian players like NRB and National Engineering Industries (under NEI Bearing brand) has also made a niche presence in the global market with reputed customers like Daimler, Volkswagen Group and others. Exports growth has supported the overall revenue growth for these entities, given the sluggish demand in domestic market over last few years, especially, due to deferment in investment activities, which has affected the industrial segment.

**Share of exports as % of sales**

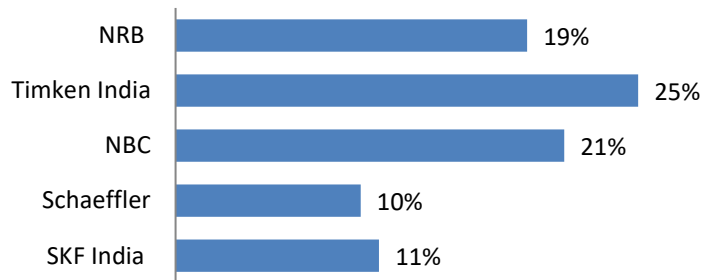

Source: ICRA Report

### Trend in bearings exports (₹ Crs)

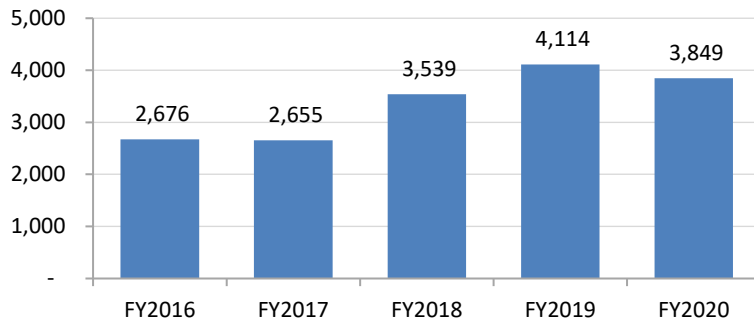

Source: ICRA Report

In terms of demand dynamics, OEMs account for 60% of demand whereas the rest is driven by aftermarket and exports. The industrial segment constitutes 50-55% of the domestic bearing demand, which is largely driven by general machines/motors, electrical equipment (fans/appliances) as well as heavy industries. Increasing automation in manufacturing units, thrust by the Government's 'Make in India' program, spending towards railways and metros will support growth of manufacturing and engineering sectors, which augurs well for the bearing industry.

In line with the global market, the domestic market can be broadly classified under the industrial and the automotive segments. However, the share of the automotive segment at 45-50% is relatively higher than the global level (<40%). This is mainly because of higher level of automation in developed countries (resulting in higher industrial activity) and large two-wheeler population in India. Usage of bearings is fairly diversified in the automotive (PV, CV, 2W, 3W, tractor) as well as the industrial segments. Also, the Indian bearing manufacturers derive a sizeable share of their revenue from exports as well as the aftermarket business, which lend stability to the business as well as mitigates the impact of cyclicity in any specific segment.

### Industrial Segment Accounts for 52% of domestic bearing demand

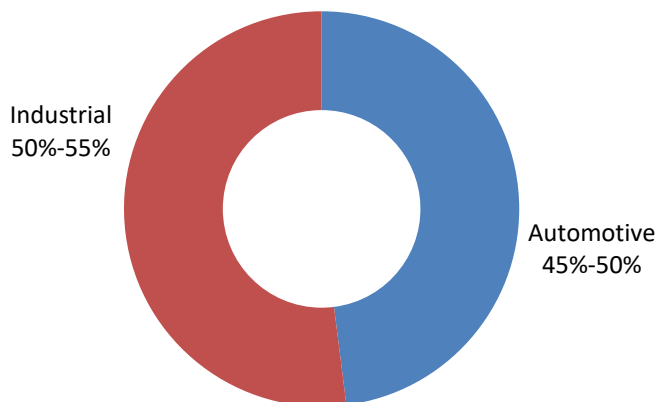

Source: ICRA Report

### Heavy industries account for bulk of industrial demand

The industrial segment accounts for 50-55% of the domestic bearing demand, which is largely driven by general machines/motors, electrical equipment (fans/appliances) as well as heavy industries. The other segment mainly includes textile and refinery businesses. Going forward, the industrial segment growth will be driven by core industries such as infrastructure, power, metals, mining and cement among others. In the medium to long term, manufacturing in locomotives is also expected to grow at a healthy pace given the government's push for dedicated freight corridor, and high-speed rail network for both freight and passenger routes. Improved safety measures for rail networks are

expected to increase spending on products and solutions with modern technology. Increasing thrust on the Government's 'Make in India' program will support growth of the manufacturing sector, which augurs well for the bearing industry.

**Owing to high 2W population, automotive bearing accounts for high share of overall bearing demand compared to global market**

Usage of bearings is fairly diversified in the automotive (PV, CV, 2W, 3W, tractor) as well the industrial segments. Also, Indian bearing manufacturers derive a sizeable share of their revenue from exports as well as aftermarket business, which lends stability to the business as well as mitigates the impact of cyclical in any specific segment.

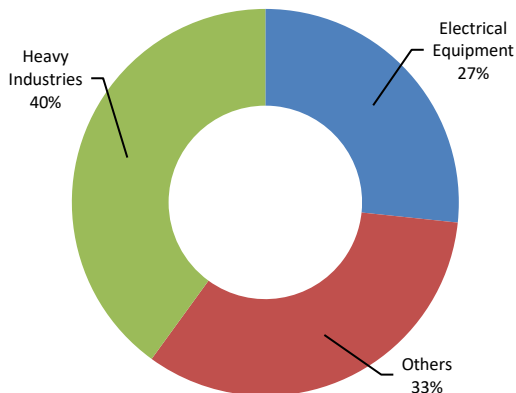

Source: ICRA Report

**Structure of Indian bearing industry by type of bearings**

**Ball bearings** - The domestic market for ball bearings is estimated at ₹ 6,000 crore, and finds application in fan, pumps, motors, alternators, two wheelers and three wheelers. SKF is a leading player in the domestic ball bearing market, followed by SCHAEFFLER, NEI, Timken and others.

**Tapered Roller Bearing** - The domestic market for tapered roller bearings is estimated at ~₹ 2,200-2,400 crore, largely dominated by Timken. SKF and SCHAEFFLER are other major players in the tapered roller bearing market. Tapered roller bearings find application in M&HCVs, railways, mining and construction equipment, conveyors, tooling units and other applications where the load is high.

**Cylindrical Roller bearings** - The domestic market for cylindrical roller bearing is estimated at ~₹ 600 crore, and it finds application in machining units, railways, gearboxes, compressors and mining equipment.

**Spherical Roller bearings** - The domestic market for spherical roller bearing is estimated at ₹ 230-250 crore, and it finds application in suspension systems, heavy industrial conveyors, industrial fans etc.

**Needle Roller bearings** - The domestic market for needle roller bearing is estimated at ₹ 2,800-3,000 crore, and it finds application in engines, industrial gearboxes, and air compressors.

While major players are present in all the key segments, they hold leadership positions in some of the segments. For example, SKF is a leading player in the domestic ball bearing market with over 40% market share, whereas SCHAEFFLER is a leading player in cylindrical and spherical roller bearings. Similarly, Timken is the market leader in Tapered roller bearings and NRB holds a dominant position in the needle roller bearing market.

**Top five players account for 80% of total market**

The Indian market is dominated by international majors i.e. SKF, Schaeffler and Timken as well as indigenous players



like NEI, NRB, ABC and others. While there are several players present in the industry, the competition is moderate as the top five players constitute ~80% of the market share.

**Market share break up**

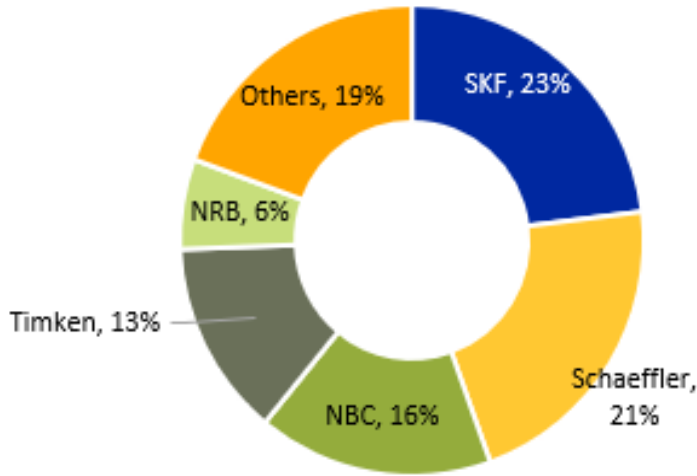

Source: ICRA Report

The bearing industry is technology as well as capital intensive industry, as end products find application in critical applications like aviation, automobile engines, railways and others. Consequently, all major players in India have product backup with their parent (SKF, SCHAEFFLER, Timken) or with a foreign collaborator. Technological collaboration with reputed global OEMs lends credibility to bearing manufacturers and acceptability to their products given the similar level of quality control followed in the Indian unit as their counterparts/collaborators in the overseas units.

Players like NRB and NEI, which earlier had technical JVs but are now working independently, are spending on R&D to sustain their market position in the Indian market. In fact, NEI is one of the select entities in the global bearing industry to have received Deming Grand prize for quality. Given the technology-intensive nature of the industry, especially in terms of precision and advanced bearings, the current structure of the industry ensures that the existing top players would continue to lead the sector.

**Cost Structure, trends in margins and key suppliers**

**Break-up of cost structure**

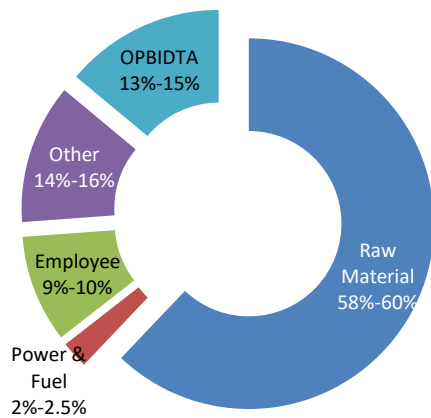

Source: ICRA report

### Steel accounts for bulk of bearing manufacturers' cost structure

In general, raw materials account for around 58-60% of the bearing manufacturers' revenue. Bearings are mainly manufactured using high grade steel or alloy steel, which exposes them to global steel price movement. Nevertheless, these manufacturers have relatively better pricing power compared to other commoditised components suppliers, which gets reflected from stable operating margin performance in the recent times.

Depending upon their requirement, bearing manufacturers usually enter into supply agreement with domestic or internal steel mills which supply steel to their vendors at pre-determined prices.

#### Trend in Operating Margin (OPBIDTA %)

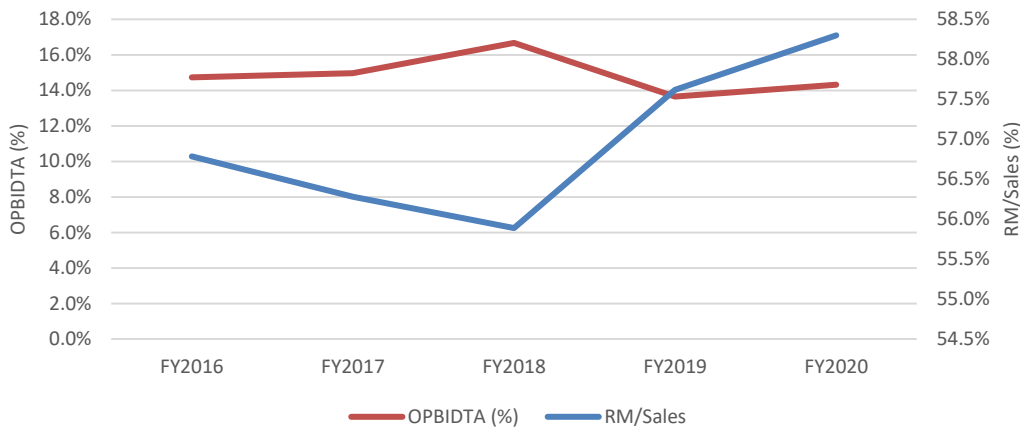

Source: ICRA report

### Operating margin stable despite underlying volatility in steel prices

Steel is the major raw material for bearing manufacturers. Bearing manufacturers have relatively strong pricing flexibility owing to the technology knowhow and strong aftermarket presence. This is also evident from stable operating margin (OPBIDTA) of around 13-15% despite underlying headwinds in steel prices as well as moderation in demand.

The gross margins of bearing manufacturers benefitted from weak commodity prices in the recent quarters. However, a sharp decline in volume and consequent negative leverage because of the Covid-19 related lockdown will result in a more than 150 bps decline in OPM in Fiscal 2021. The OPMs are likely to recover to the normal level from Fiscal 2022 onwards.

### Bearing Components and major suppliers in India

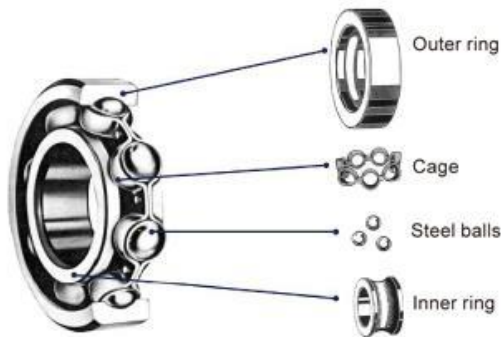

Source: ICRA report

The main components for bearings include five basic parts, i.e. inner ring, outer ring, rolling element, cage and seals. The inner and outer rings are commonly referred to as bearing rings/races.

**Inner Rings:** This is the smaller of the two bearing rings and gets its name from the position it holds. It has a groove on its outside diameter to form a path for the balls. The surface of this path is precision finished to extremely tight tolerances and is honed to a very smooth, mirror-like surface finish. The inner ring is mounted on the shaft and is usually the rotating element.

**Outer Rings:** This is the larger of the two rings and, like its counterpart, the inner ring, its name is derived from the position it holds. Conversely, there is a groove on its inside diameter to form a pathway for the balls. This surface also has the same high precision finish of the inner ring. The outer ring is normally placed into housing and is usually held stationary.

**Rolling Element:** These are the rolling elements that separate the inner and outer rings and permit the bearing to rotate with minimal friction. Rolling elements can be balls, cylindrical rollers, spherical rollers, tapered rollers and oil in case of journal type of bearings.

**Cage:** The main purpose of the cage is to separate the balls, maintaining an even and consistent spacing, to accurately guide the balls in the paths, or raceways, during rotation, and to prevent the balls from falling out.

**Seals:** Seals /shields are used to keep contaminants out of a bearing. Seals can be classified as contact seals or non-contact seals. Contact seals are generally very reliable, particularly when wear is kept to a minimum by producing an appropriate surface finish for the counter face and by lubricating the seal lip/counterface contact area.

ICRA estimates that domestic bearing components suppliers have a market potential of ₹ 4,500 crore as rest of the demand is catered by finished goods imports. Out of the bearing raw material cost, bearing rings/races account for the major share of raw materials followed by rollers, cages and seals.

#### ***Key bearing components and their suppliers***

<b>Product Name</b>	<b>Suppliers</b>
Bearing Ring/Races	Rolex Rings Limited (Rolex), Ravi Technoforge India Private Limited (RTPL), Agrasen Engineering, Kirti Forgings
Rollers	Vishal Bearings Limited, NHB Ball and Roller Limited, Kansara Modler Limited
Bearing Seals	Seeco Industries Limited, Ashutosh Rubber Private Limited
Bearing Cages	Harsha Engineers Limited, Bharadia Engineering Industries

*Source: ICRA Report*

#### ***Bearing Rings industry***

Bearing Rings form one of the most critical and largest raw material cost for the bearings sector and at ~ ₹ 2,200 crores, the industry contributes ~18.3% of the size of domestic bearing market. Rings can be manufactured using tubes, cold-drawing of steel bars or by forging process. Amongst these three processes, forged rings are mainly used in critical applications where load/stress is relatively high. Forged bearing rings market is estimated at about Rs 1,100 crore of overall bearing rings market while the balance is split across rings manufactured using tubes and cold-drawing of steel bars. Given that bearings find application in computer hardware to aerospace industry, and can vary from few millimeters in diameter to tens of meters the complexity of bearing ring varies with its proposed applications, weight and size. While, the entry barrier is relatively lower for smaller bearing rings with high tolerances, the technological knowhow as well as manufacturing capabilities becomes a differentiating factor as complexity/size of bearing increases.

The manufacturing process and competitive intensity is also determined by the raw materials being used, machining requirements post forging and surface treatments required to be given to the bearing rings. Being a critical component for the overall performance of the bearing and consequentially the end-use application and thus manufacturers of high precision bearing rings need to adhere to stringent quality standards and adhere to strict tolerance levels. Being an important part of the bearing, the bearing manufacturers tend to restrict the churn in suppliers and prefer to work with

approved vendors which is reflected in relatively long customer retention seen in bearing ring manufacturing sector.

In addition to the above, manufacturing of high precision, high volume, forged small bearing rings requires advanced hot-formers which entail significant capex for the manufacturing units. The growth in the segment will be driven by growth in bearings industry as well as increased propensity of bearing companies to outsource the manufacturing of bearing rings. The largest costs for forged bearing ring manufacturers are raw material (steel), power and manpower. Steel being a cyclical commodity, most large players in the industry strive to pass-through the raw material costs to their customers thereby partially insulating themselves from the changes in commodity prices.

Indian forgings players like Bharat Forge Limited (BFL) and Ramkrishna Forgings Limited (RFL) as well as forged bearing rings manufacturers like Rolex Rings Limited (Rolex) have developed in-house capabilities to cater to the requirement of large rings (using ring-rolling facility), which are higher value-added products with relatively lower competitive intensity. Also, the share of value addition in the form of higher machining content supports margin expansion for supplier apart from the benefits of low rejection rate at the customer’s end.

### Outlook for Bearings Industry

Lockdown-related restrictions impacted the revenue in Q1 FY2021, however, industry participants have witnessed a V-shaped recovery from Q2 FY2021 onwards, supported by inventory re-stocking at distributorship, stable aftermarket demand and a recovery in the automotive production. With the opening up of economy, business activities have picked up, which is also reflected in the IIP trend. Moreover, BS-VI transition has facilitated higher realisation/content per vehicle, which also supported performance in Q2 FY2021.

Revenue growth in the bearing industry is essentially a reflection of the underlying investment cycle (which is also linked to the overall GDP growth) as well as demand dynamics in the domestic automotive industry. Incremental investments towards capacity creation and hence towards new (heavy) machinery drive demand for industrial bearings. Similarly, demand momentum in the automotive and the tractor segments is the key driver for bearings demand in the automotive industry. Generally, wide application across various industries as well as a healthy aftermarket demand provides support to the bearing industry which is also reflected in 10.1% CAGR revenue growth during Fiscal 2013 to Fiscal 2019. Nevertheless, simultaneous meltdown in demand across automotive as well as the overall industrial demand during the last 12-18 months resulted in a moderation in revenue growth for the bearings manufacturer.

Over the last 3-4 years, sub-optimal capacity utilisation by most corporates resulted in deferment of capex plans, and consequently the demand for bearings was primarily driven by the automotive as well as the aftermarket segments. With recovery in domestic automotive industry as well as likely pickup in investment activity under PLI scheme will result in healthy revenue growth for the sector. ICRA expects overall revenue to grow by 9%-11% CAGR for industry during Fiscal 2021 to Fiscal 2025 period.

Aggregate Revenue Trend (Annual)

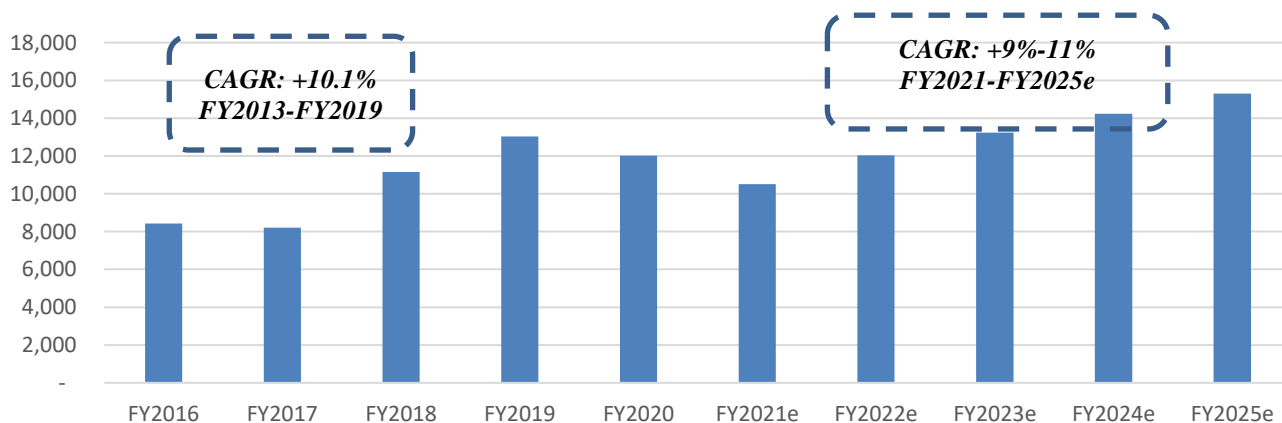

Source: ICRA Report

Currently, about 40% of the domestic bearing requirement is catered through imports as volume in India for certain SKUs are economically viable for bearing manufacturers to set up dedicated lines. With an improved off-take, bearings will get increasingly localised, which will help bearing component suppliers in the medium to long term. Hence, the demand for domestic bearing components (rollers, rings) is expected to grow at a faster rate (~10-12% CAGR) than the underlying bearing industry. Moreover, increasing complexity of bearings will further add to realisation for bearing component suppliers. While the operating margin in Fiscal 2021 will be impacted owing to weak Q1, the overall operating margin of the industry is likely to remain rangebound at around 13-15% in the medium term.

#### Aggregate Operating Margin Trend (Annual)

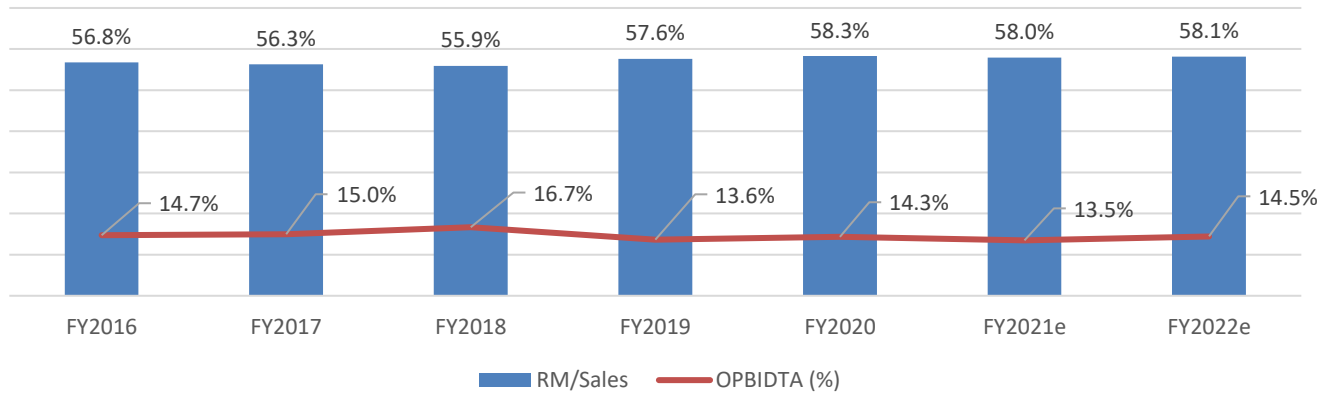

Source: ICRA Report

#### INSIGHT ON THE AUTOMOTIVE INDUSTRY

The global light vehicle (including passenger vehicle and light commercial vehicles) unit sales registered a 4.5% -5% decline in CY2019, and the volumes are likely to shrink further by over 15% in CY2020 due to the Covid-19 related impact on economy and consumer sentiments. The decline will be the sharpest in the European markets, especially in Spain and Italy, which were worst impacted by the pandemic.

#### Growth outlook for key automotive markets

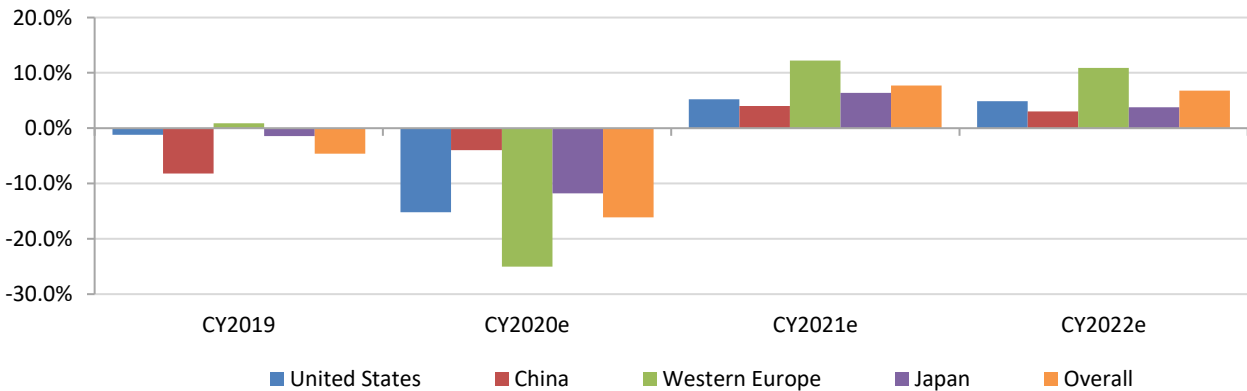

Source: ICRA Report

Source: ICRA research; Note: data pertains to light vehicle market

## Both US and European CVs will witness handsome recovery in CY2021

- The US Class 8 truck volume will witness the steepest decline in the last decade, but the overall volume will still be higher than the volume witnessed in CY2009 post the financial crisis. The recent order inflow is encouraging, which indicates a sharp recovery in CY2021.

*Order inflow indicates sharp recovery in CY2021*

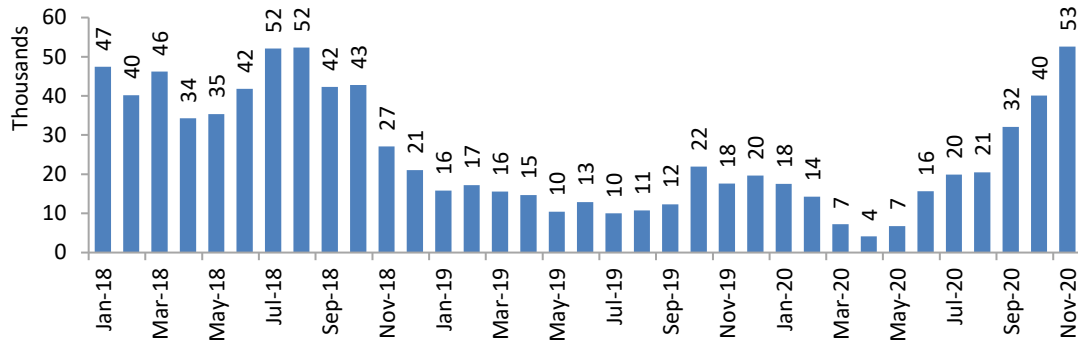

Source: ICRA Report

- The European CV demand will also witness a handsome recovery in CY2021, supported by an improvement in economic activity as well as the low base effect of CY2020.

## India Automotive Market – Most Automotive Subsegments will register double digit growth in Fiscal 2022e

The domestic OE demand was already reeling under demand pressure prior to the Covid-19 because of a slowdown in the economic activity, tighter financing cost, transition impact of various regulations (safety/emission/axle-load norms) and weak consumer sentiments. The Covid-19 aggravated the situation, with sharp decline in volume during Q1 FY2021 though the industry witnessed handsome recovery during Q2 FY2021 and Q3 FY2021 which is likely to continue in coming quarters as well. ICRA expects all major automotive sub-segments to witness strong double digit growth in Fiscal 2022, albeit on low base of Fiscal 2021.

Chart 9: Domestic Automotive Demand (Long Term Trend)

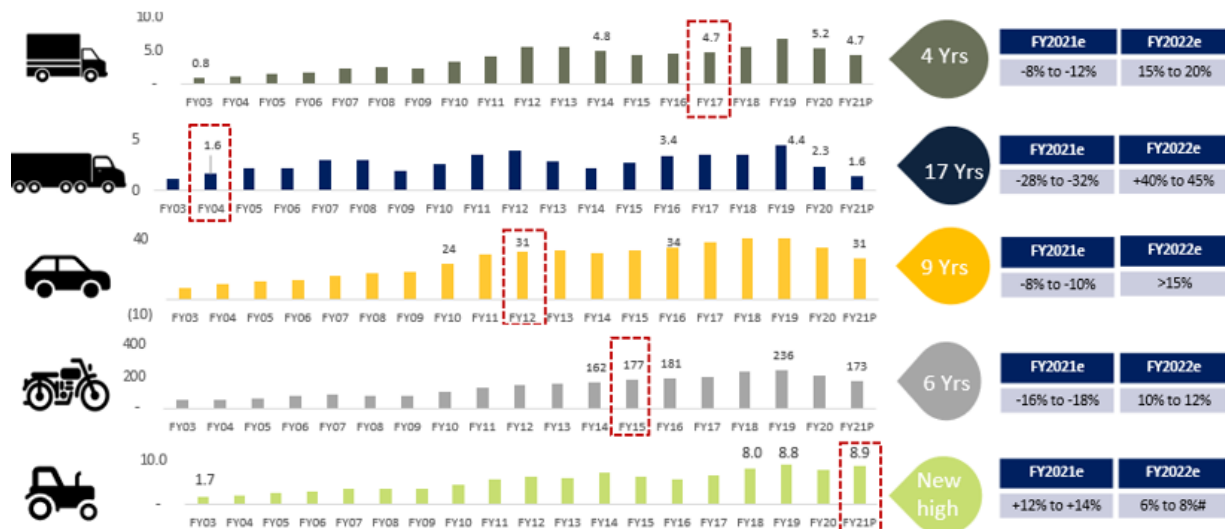

Source: ICRA Report

## India Automotive Market – Outlook for various segments

**Commercial vehicles** – The domestic Commercial Vehicle industry is expected to grow in Fiscal 2022, supported by the low base, improvement in economic activity and financing environment. Infrastructure activity, one of the key growth levers for the heavier CVs, has seen increased execution in recent months, and is expected to be further augmented by the significant capital outlay of ₹ 5.54 lakh crore announced in the recent Union Budget.. The much-awaited scrappage policy, which is expected to be announced soon, would also provide some impetus to volumes, with vehicles older than 15 years required to undergo a mandatory fitness test. Overall, ICRA expects the domestic CV Industry volumes to report double-digit growth of 24-27% in the upcoming fiscal, after two years of sharp contraction.

**Passenger vehicles** – Demand recovery post lockdown relaxation is much better than expectations with industry registering 17.0% and 14.4% growth during Q2FY2021 and Q3FY2021, respectively. ICRA expects over 15% growth in PV sales during Fiscal 2022. The growth will also look better due to low base effect of Fiscal 2021, especially Q1 Fiscal 2021. Within PV segment, UV segment will continue to outperform which is also in line with global trend. In the medium term, ICRA expects UV segment to account for over 40% of total PV sales in the Indian market.

**Two wheelers** – Over the past few years, strong growth in domestic 2W demand was largely driven by outperformance in scooter segment whereas motorcycle demand, especially in commuter segment remained sheepish. The trend however reversed in recent quarters with motorcycle segment witnessing healthy demand. This can be attributed to greater rural demand, which is expected to remain buoyant due to higher disposable income with farmers resulting from healthy Government procurement of the kharif crop. Increased preference for personal mobility in urban markets, to maintain social distancing, is also expected to support retail demand.

**Tractors** – Aided by healthy rabi cash flows across the regions and progress of the monsoon (in line with the forecasts), there has been a sequential improvement in tractor sales ever since. After a strong surge in the wholesale volumes during June-September 2020, the growth moderated to an extent in October 2020 (~8% growth on a YoY basis), partially because of a higher base. Even as wholesale growth moderated to an extent, the tractor industry continued to record a robust growth in retail volumes (~57% on a YoY basis). OEMs continue to be focused on maintaining healthy production levels and are optimistic of healthy sales for the rest of the year.

### Indian Auto Component Industry – Overview

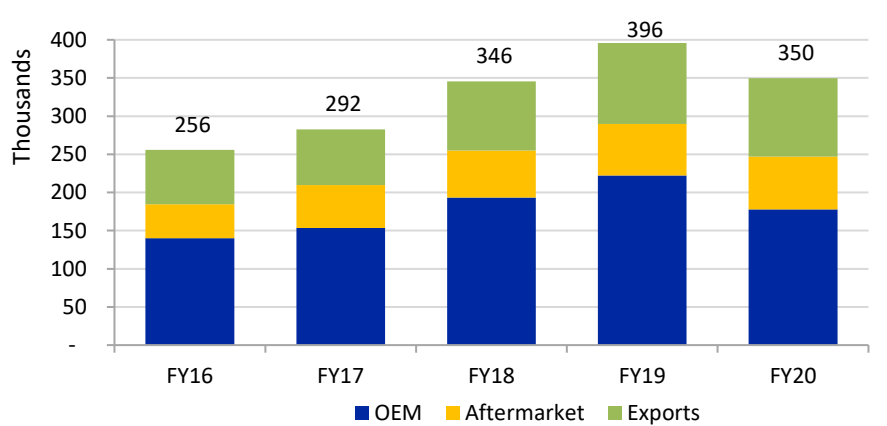

Source: ICRA Report

Supported by a healthy revenue export growth, a stable aftermarket growth and improving content per vehicle, the domestic auto component industry witnessed a healthy CAGR of 9.7% during Fiscal 2011-2019. However, a slowdown in domestic automotive demand as well as the lockdown impact during March 2020 resulted in a 11.7% decline in the auto component industry revenue in Fiscal 2020.

As per ACMA, the Indian auto-component industry size is estimated at ₹ 3,49,637 crore in Fiscal 2020.

In terms of product segmentation, engine and engine component account for the bulk of the auto component industry

in terms of revenue followed by transmission and steering components, suspension and braking system and body and chassis parts. Generally, technological entry barriers are highest in engine and transmission system, and minimal in press metal components and sheet metal parts. Nevertheless, even in sheet metal parts, OEMs generally outsource interior blanks & parts whereas skin panels are generally manufactured by OEMs themselves.

**India continues to be net importer of auto components, although the gap is steadily reducing**

*Trend in Export and Import of Auto components (in USD billion)*

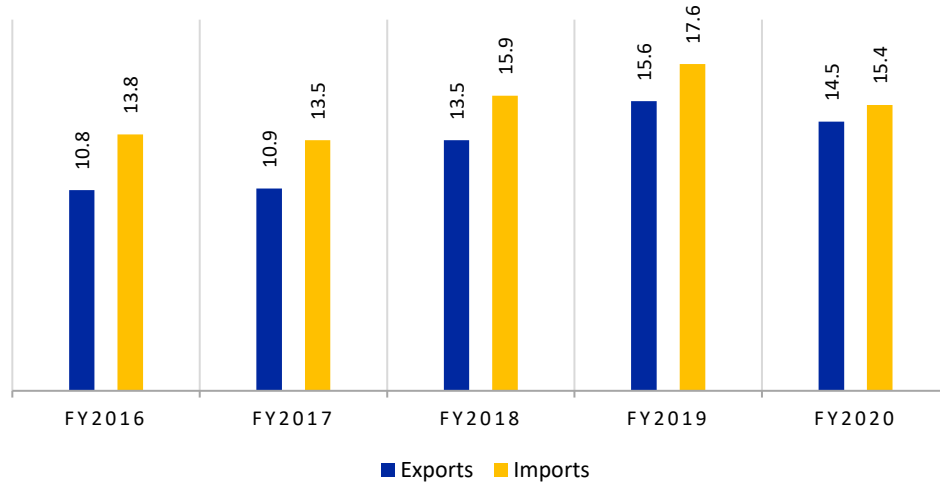

Source: ICRA Report

**Auto component Industry expected to grow at a CAGR of 10%-12% during Fiscal 2021- Fiscal 2025**

ICRA expects export revenues to grow at a healthy pace, supported by the Government’s ‘Make in India’ initiative, increasing exports by a few domestic OEMs and a healthy growth in the US automotive market. Over the medium to long term, increasing efforts by the OEMs on localisation of raw materials and increasing component value/sophistication per vehicle platform are positives for the industry. Further, revenue growth is expected to accelerate from Fiscal 2022, with robust growth expectation for the 2W, PV and CV industry. With increasing import substitution, thrust of ‘Make in India’ (to boost exports) and an overall improvement in demand, we expect the industry to witness a CAGR of 10%-12% during Fiscal 2021- Fiscal 2025, with an upward bias.

**ICRA Revenue Growth Estimates for Auto Component Industry**

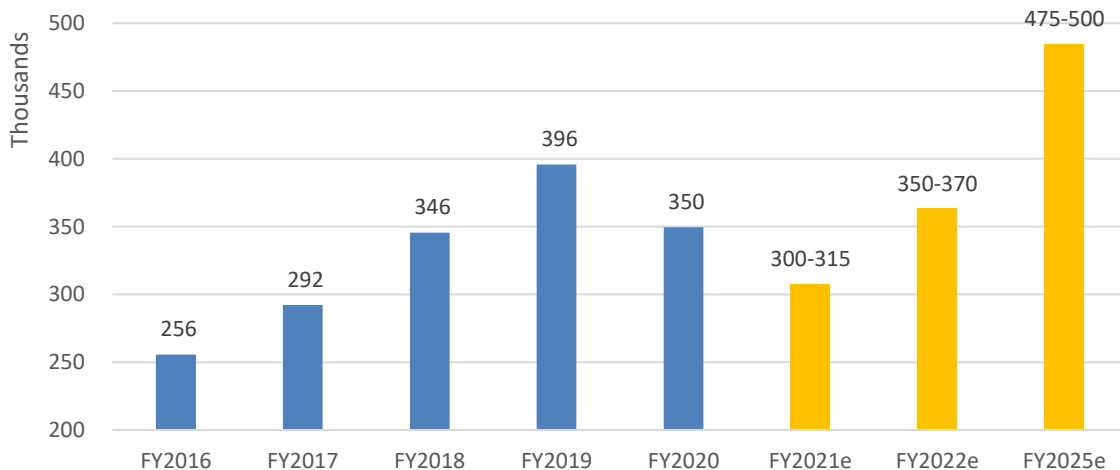

Source: ICRA Report



Over the medium to long term, growth in the auto component industry will be higher than the underlying automotive industry growth, given the increasing localisation by OEMs, higher component content per vehicle and rising exports from India. We maintain our medium-term margin outlook of ~13%-14% compared to the sub-12% level witnessed prior to Fiscal 2012 owing to a richer product mix and rising revenues from the profitable aftermarket segment.

### Indian Forging Industry

The Indian forging industry is among the key contributors of the manufacturing sector and one of the key growth drivers for the auto component exports. Being a labour-intensive process, Indian forging companies have cost advantages over its peers in the developed market. Over the years, Indian forging companies have gained technical knowhow in making critical components as well as improved share of machined content, which has helped margin expansion for some of the larger players.

As per the Association of Indian Forging Industry (AIFI), the country's forging industry had an installed capacity of 4.7 million MTPA capacity and a turnover of ₹ 34,000 crore in Fiscal 2020 (compared to ₹ 45,000 crore in Fiscal 2019). The automotive sector accounts for 60% of the forging production whereas the rest is catered to by the non-automotive segments like oil & gas, locomotive, defence and other applications.

Based on their installed capacity, the forging units can be classified as very large (capacity above 75,000 MT), large (capacity above 30,000 to 75,000 MT), medium (capacity above 12,500 to 30,000 MT), small (capacity above 5,000 to 12,500 MT) and very small (capacity up to 5,000 MT). As per AIFI, about 83% of the total forging units are classified as small and very small, while about 8% can be classified as very large and large units. The medium sized units constitute the balance 9%.

#### *Installed capacities of major forging companies in India*

Company Name	Installed Capacity (MTPA)
Bharat Forge Limited	406,150
Amtek Group	300,000+
Mahindra CIE Automotive Limited*	170,000+
Ramkrishna Forgings Limited	170,000
Rolex Rings Limited	144,750
MM Forgings Limited	100,000
Echjay Industries Private Limited	70,000
Happy Forge Limited	60,000
Sadhu Forging Limited	40,000
Super Autoforge Private Limited	30,000

**Source:** ICRA Report, company websites and investor presentation

\*including 120,000 MTPA capacity of Bill Forge Private Limited; List excludes forging capacity setup by customers for internal consumption

The industry's performance in Fiscal 2020 and YTD Fiscal 2021 was impacted by a slowdown in the automotive demand, which is also reflected in a sharp decline in profitability and liquidity position of listed forging entities. Sequentially, the situation is likely to improve for forgings suppliers with a pick-up in domestic as well as exports automotive demand. Over the medium to long term, the Government's thrust on increasing localisation content for the defence platform augurs well for the industry.

## OUR BUSINESS

*This section should be read in conjunction with the sections titled “Risk Factors”, “Management’s Discussion and Analysis of Financial Condition and Results of Operations” and “Financial Statements” on pages 22, 224 and 161, respectively. In this section, unless the context requires otherwise, any reference to the terms “we”, “us” and “our” refers to our Company. Unless otherwise stated or the context otherwise requires, all financial and other data regarding our Company’s business and operations presented in this section is derived from the Restated Financial Statements.*

*Certain information in this section is also derived from the report titled “Indian Bearings Industry – Industry revenue to witness a smart recovery in FY 2022” prepared by ICRA Limited, an independent consultant, pursuant to engagement with our Company (“ICRA Report”). Reliance on such information for making an investment decision in the Offer is subject to inherent risks. See “Risk Factors – Statistical and industry data in this Prospectus may be inaccurate, incomplete or unreliable. Certain sections of this Prospectus disclose information from industry reports commissioned by us and any reliance on such information for making an investment decision in the Offer is subject to inherent risks” on page 41 for further information. For the text of the disclaimer clause of the Report, see section titled “Certain Conventions, Use of Financial Information and Market Data and Currency of Presentation” on page 11.*

### Overview

We are one of the top five forging companies in India in terms of installed capacity (*Source: ICRA Report*) and a manufacturer and global supplier of hot rolled forged and machined bearing rings, and automotive components for segments of vehicles including two-wheelers, passenger vehicles, commercial vehicles, off-highway vehicles, electric vehicles), industrial machinery, wind turbines and railways, amongst other segments. We supply domestically and internationally to large marquee customers including some of the leading bearing manufacturing companies, tier-I suppliers to global auto companies and some auto OEMs. As per ICRA Report, SKF India Limited, Schaeffler India Limited Timken India Limited, NEI and NRB collectively account for 81% of the market share of Indian bearing industry. We are one of the key manufacturers of bearing rings in India (*Source: ICRA Report*) and cater to most of the leading bearing companies in India.

We started our manufacturing operations in 1988 with our first manufacturing plant set up in Rajkot. As on date of this RHP, we have three manufacturing units in Rajkot. Our manufacturing infrastructure includes high-speed hot formers from Sakamura (such as Sakamura model HBP-160, Sakamura Model HBP – 120SS and Sakamura Model: HFW-1000-4 Hot Former) and Hatebur (such as Hatebur Hotmatic – HM75XL Hot Former and Hatebur-Hotmatic@ HM 35 Machine) and vertical forging lines from Manyo (Manyo 600 tons Auto Forging Press), Mistubishi, SMS Meer (such as SMS MEER Ring Rolling line), Enomoto (such as Enomoto Model 1000ZESH and Servomoto Driven Screw Press 16000kN), Eumoco and conventional forging lines integrated with induction heating furnaces. A large part of our existing machining lines consist of spindles from DMG, FUJI, ACE, TSUGAMI, Hyundai, Mazak, Muratec and domestic CNC Turning centres as well. As on date of this RHP, we have 22 forging lines with a combined installed capacity of 1,44,750 MTPA, machining facilities consisting of 528 spindles with a combined installed capacity of 69 million parts per annum and other machinery including heat treatment furnaces, cold rolling machines and other infrastructure.

Our product portfolio includes a wide range of bearing rings, parts of gear box and automotive components, among others. Our manufacturing capabilities are complemented by our tool design, engineering and product development capabilities. Till date, we have offered a diverse range of hot forged and machined alloy steel bearing rings weighing from 0.01 kilograms to over 163 kilograms, and with inner diameter of 25 millimeters to outer diameter of 900 millimeters. This makes our products suitable for a wide range of end-user industries such as automotive, railways, industrial infrastructure, renewable energy, among others.

Our customers typically order in large volumes, and we cater to their orders by using our flexible manufacturing infrastructure, skills and processes to achieve operational efficiency and quality. For Fiscal 2021, we supplied bearing rings and automotive components to over 60 customers in 17 countries, primarily located in India, United States of America and in European countries such as Germany, France, Italy, and Czech Republic, and Thailand. We have been able to maintain long standing relations with our customers and 70% of our 10 largest customers for Fiscal 2021 have been with us for over a decade.

In the past, we have received awards from our customers in relation to our products, such as ‘Supplier Quality Excellence Award’ from General Motors in 2018 and 2019 and ‘Excellence in New Product Development’ from Timken in 2018. We have also received various certifications, demonstrating our dedication and commitment to quality and service excellence. Further, our Company is in the process of renewing its IATF 16949 (International Standard for Automotive Quality Management Systems) and ISO 9001 (International Standard for Quality Management Systems) certifications which pertains to quality management systems and such renewal has been recommended by TUV NORD - Germany. Our Company has recently also received ‘Q1 Preferred Quality Status’ award in May 2021 from Ford.

We intend to de-risk our business’ dependence on changes in power tariffs and reduce our carbon footprint through investment in renewable energy. As on date, the Company operates windmills with installed capacity of 8.75 MW. We are in the process of expanding capacity of our solar projects by an installed capacity of 16 MW and have already placed purchase orders for equipment with installed capacity of 7.35 MW. We believe that the proposed expansion will help us in reducing our carbon footprint and expanding our profit margins.

Our revenue from operations for Fiscal 2021, 2020 and 2019 ₹ 6,163.32 million, ₹ 6,659.94 million, and ₹ 9,043.23 million respectively and EBITDA margin were 18.12%, 19.36%, and 22.83%, respectively for the corresponding period. For Fiscal 2021, 2020 and 2019, our revenue from operations from outside India as a percentage of revenue from operations were 56.12%, 53.82%, and 56.27%, respectively. Further, our revenue from sale of products can be attributable to the following sources:

		(₹ in million)		
S. No	Source of revenue	Fiscal		
		2021	2020	2019
1.	Bearing rings	3,309.65	3,498.15	5,345.34
2.	Auto components	2,373.65	2,660.78	2,944.13

## Strengths

We believe the following competitive strengths differentiate us from other industry participants.

### *We have a comprehensive product portfolio*

We have a comprehensive portfolio of products in the markets in which we operate. Till date, we have offered a diverse range of hot forged and machined alloy steel bearing rings weighing from 0.01 kilograms to over 163 kilograms, and with inner diameter of 25 millimeters to outer diameter of 900 millimeters. This makes our products suitable for a wide range of end-user industries such as automotive, railways, industrial infrastructure, renewable energy, among others. We also offer auto components such as wheel hubs, shafts and spindles, gears, etc. Our strength in our product portfolio is shown by the fact that we supply domestically and internationally in each of our product segments.

We believe that our product portfolio helps us in offering a wide range of products to our customers, enhances our ability to attract new customers, improve our share of business amongst existing customers and helps de-risk the business through limited dependence on any single product category. We believe that our product portfolio, has helped us, to become one of the leading forging manufacturers and suppliers of bearing rings and automotive components.

### *Manufacturing capabilities which offer scale, flexibility and locational advantage.*

We are one of the top five forging companies in India in terms of installed capacity (*Source: ICRA Report*). We started manufacturing of forging and forged products in 1988 have grown organically by setting up our second and our third manufacturing plant. As on date of this RHP, we have three manufacturing units that are all in Rajkot with an annual achievable capacity of 144,750 MTPA in forging and 69 million parts per annum in machining. We are one of the key manufacturers of bearing rings in India (*Source: ICRA Report*).

We believe that our investment in infrastructure permits us the flexibility to manufacture high volume parts in a cost-effective manner. For instance, our high-speed hot formers are best suited for high volume precision components while our vertical forging lines are ideally suited for medium as well as lower volume production. We believe that this helps

us address a wide range of end user industries and also helps us in servicing our customers across a broader product horizon.

We believe that the location of our manufacturing facilities at Rajkot helps us in accessing the various automotive clusters in North India, West India and South India as well as cater to the export markets through close proximity to the ports of Kandla, Mundra and Pipavav. We believe that we have also been benefited by the presence of smaller machining units in Rajkot which we opportunistically use for pre-machining and the presence of trained manpower which helps us in hiring for our manufacturing operations.

As on date of this RHP, our manufacturing infrastructure includes high-speed hot formers from Sakamura and Hatebur and vertical forging lines from Manyo, Mistubishi, SMS Meer, Enomoto, Eumoco and conventional forging lines integrated with induction heating furnaces. A large part of our existing machining lines consist of spindles from DMG, FUJI, ACE, TSUGAMI, Hyundai, Mazak, Muratec and domestic CNC Turning centres as well. As on date of this RHP, we have 22 forging lines with a combined installed capacity of 1,44,750 MTPA, machining facilities consisting of 528 spindles with a combined installed capacity of 69 million parts per annum and other machinery including heat treatment furnaces, cold rolling machines and other infrastructure. While we out-source some pre-machining operations to take advantage of lower costs offered by vendors, our infrastructure enables us to complete most of our manufacturing processes in-house which allows us to respond quickly and efficiently to any customer requirements or change in product specifications without the need to depend on any external vendors. This also helps us in closely monitoring product quality, production costs and delivery schedules.

Further, our investments in wind and solar energy helps us to mitigate risks posed by changes in cost of power and fuel and helps us in reducing our carbon footprint. We are in process of setting up a 16 MW ground mounted solar power facility at Taluka Muli (Gujarat) which should further de-risk our business vis-à-vis the cost of power and fuel. For Fiscal 2021, the power generated by our windmills and existing solar power facilities was approximately 10.1 million units as compared to the overall power units consumed by us of approximately 57.1 million units.

As on date of this RHP, our Company has unutilized land area of 32,071.44 square metres at Rajkot which can be utilized for any further expansion. In addition, our Company also owns 691,312 square metres of land in Taluka Gondal (Gujarat). In addition to the above, our Company also owns certain other parcels of land, including for the purposes of setting up a solar plant at Taluka Muli (Gujarat).

#### ***Long standing customer relationships and geographically diversified revenue base***

For Fiscal 2021, we supplied bearing rings and automotive components to over 60 customers in 17 countries, primarily located in India, United States of America and in European countries such as Germany, France, Italy, and Czech Republic, and Thailand. Notably, we supply domestically and internationally to some of the leading manufacturers of bearings, Tier-I and Tier-II auto-component suppliers and certain auto OEMs. We have been able to maintain long standing relations with our customers and 70% of our 10 largest customers for Fiscal 2021 have been with us for over a decade. While our customers are not required to specify the end use of our products to us, we believe that our products find end use across automobile sector (including two-wheelers, passenger vehicles, commercial vehicles, off-highway vehicles, electric vehicles), industrial machinery, wind turbines and railways, amongst other segments.

We have received multiple awards from our customers including such as ‘Supplier Quality Excellence Award’ from General Motors in 2018 and 2019 and ‘Excellence in New Product Development’ from Timken in 2018. We believe that these awards act as an endorsement of our operational and managerial capabilities and help us solicit new business from potential customers in the same industry.

#### ***Experienced Promoters and management team with strong domain expertise***

We are led by an experienced management team that we believe has the expertise and vision to manage and grow our business. Mr. Manesh Dayashanker Madeka, Chairman and Managing Director, has over 40 years of experience in the industry and has been engaged with our Company since its inception. Our production and planning related business is led by Mr. Bhautik Dayashanker Madeka, whole time Director and our marketing functions and the development of new customers and products related business is led by Mr. Mihir Rupeshkumar Madeka, both of whom have over 18 years of experience in the industry. In addition to our Promoters, members of our senior management team have

an average experience of over 24 years with most of such team members having been in our Company for more than a decade. We believe that the knowledge and experience of our Promoters, along with senior and middle-management, and our team of sales and marketing employees provide us with a competitive advantage as we seek to expand in our existing markets and enter new geographic markets.

Our senior management team contributes to the overall strategic planning and business development of our Company and is also instrumental in the growth in our revenues and operations. We believe that our experienced Promoters, senior management team and technically skilled employee base have contributed to the growth of our operations and the development of in-house processes and competencies.

### ***Strong financial performance over the past three years***

Our Company has been able to significantly improve its financial profile with debt-equity ratio improving from 1.79 times as at March 31, 2019 to 0.70 times as of March 31, 2021 which is also reflected in the credit rating CARE BB, Outlook Stable. We have been able to achieve this through net cash flow from operating activities which for Fiscal 2021, 2020, and 2019 were ₹ 592.14 million, ₹ 1,837.77 million, and ₹ 1,938.05 million respectively.

During Fiscal 2021, 2020, and 2019, our Company has spent ₹ 387.29 million, ₹ 160.94 million, and ₹ 367.41 million respectively towards purchase of property, plant and equipment and intangible assets (including capital advances) and capital work in progress. These investments have been made towards expanding our forging and machining capacity, heat treatment facilities, and investments into equipment for generation of solar energy.

### **Strategies**

We will continue to seek opportunities to realize sustainable growth of our business. To achieve this, we plan to focus on the following strategies:

#### ***Increasing our share of business amongst existing customers***

We believe that our industry is characterized by long validation process from prospective customers. Over the years we have developed longstanding, extensive relationships with our customers and believe that we are amongst the preferred suppliers or partners to some of the OEMs and Tier 1 suppliers. We intend to continue focussing on increasing our share of business from our existing customers by broadening the portfolio of products we offer, higher engagement with our existing customers, investment in our manufacturing infrastructure, and to continue to engage with such customers during new product development.

We intend to leverage our long-standing relationships, knowledge of requirements and preferences of our customers, to develop and supply more complex, higher margin products. Further, we shall strive to consolidate our relationship by continuing to provide quality products at competitive prices and focus on developing our products in line with the changing customer requirements.

#### ***Expand our customer base***

Historically, our ability to enter into new customer relationships has been critical to our growth. Certain of our customers are part of large groups with operations across geographies and legal entities. While many of such legal entities take decisions on a standalone basis with respect to vendors, we believe that our pre-approval for certain other entities across the same group including adherence to quality standards and track-record should enable us to expand into such units where we do not have a supply relationship as on date.

We also intend to continue to leverage our products and our long-term relationships and credentials with our existing customers and referrals from such customers to further develop and strengthen our customer base. We believe that there are certain geographies including Europe and India where we are under-penetrated on automotive components and will strive to improve our market share in such geographies. For instance, our Company has recently entered into

a multiyear long-term agreement with a leading Tier-I supplier (for supply of components to its plant at Europe) with an estimated annual value of approximately 10 million Euros.

#### ***Continuing focus on improving operational efficiency***

We aim to continue to improve profitability by constant cost optimization, improving product mix by enhancing contribution of higher-value added machined products and increasing capacity utilization. We also constantly aim to identify opportunities to implement product improvements and dedicated research and development resources to optimize production processes. For instance, we have implemented automation solutions in certain of our machining centres to reduce cycle times and reduce manpower requirements.

We continuously evaluate the cost-benefit of outsourcing non-critical operations so that we can focus our efforts on delivering the best quality products within our core areas. For instance, we outsource certain pre-machining operations which helps optimize utilization of our current machining capacity.

Further, we believe our large size and scale also enables us to produce greater volumes of products from our facilities and spread our fixed costs more widely to reduce our production costs on a per unit basis, allowing us to reduce our unit sales price and increase our competitiveness.

#### ***Further enhance our manufacturing infrastructure and product portfolio***

We believe that, given our manufacturing capacity and capabilities, we would be able to successfully manufacture and sell a larger variety of forged and machined bearing rings and automotive components, at competitive prices. We also intend to enhance our capabilities in machining and post machining processes so that we can increase the share of value-added and high-margin components. We are in the process of expanding our machining capacities and heat treatment facilities.

Further, we continue to evaluate changes in technology, market trends, customer preferences and will seek to make investments to cater to such change in market landscape. In the long run, we also intend to enter into new product lines and target new consumer segments. For instance, we are evaluating making investments into cold forging which may help us in expanding the product basket.

#### ***Reduce our power costs and reduce our carbon footprint***

Power and fuel expenses contributes one of the largest single expense for the Company and accounted for 8.45%, 8.14%, and 7.91% of the corresponding total revenue from operations for Fiscal 2021, 2020, and 2019, respectively. Currently, we depend on state electricity board for most of our power requirements and are subject to changes in power tariffs by state electricity board.

We intend to de-risk our business' dependence on changes in power tariffs and reduce our carbon footprint through investment in renewable energy. As on date, the Company operates windmills with installed capacity of 8.75 MW. We are in the process of expanding capacity of our solar projects by an installed capacity of 16 MW and have already placed purchase orders for equipment with installed capacity of 7.35 MW. We believe that the proposed expansion will also help us in expanding our profit margins.

#### ***Further improve our financial risk profile***

We are scheduled to exit the CDR scheme in March 2022 which should offer us improved flexibility in managing our borrowings and taking other business related decisions. For details of various restrictions imposed on us through the CDR Package, please refer to “*History and Certain Corporate Matters - Defaults or rescheduling/restructuring of borrowings*” on page 133.

For Fiscals 2021, 2020, and 2019, our net cash flow from operating activities was ₹ 592.14 million, ₹ 1,837.77 million, and ₹ 1,938.05 million respectively. We intend to use the net proceeds from the IPO and internal accruals to further

improve our financial profile. We believe that our healthy financial profile permits us to explore new opportunities and invest in expanding our capacities.

**Global Footprint**

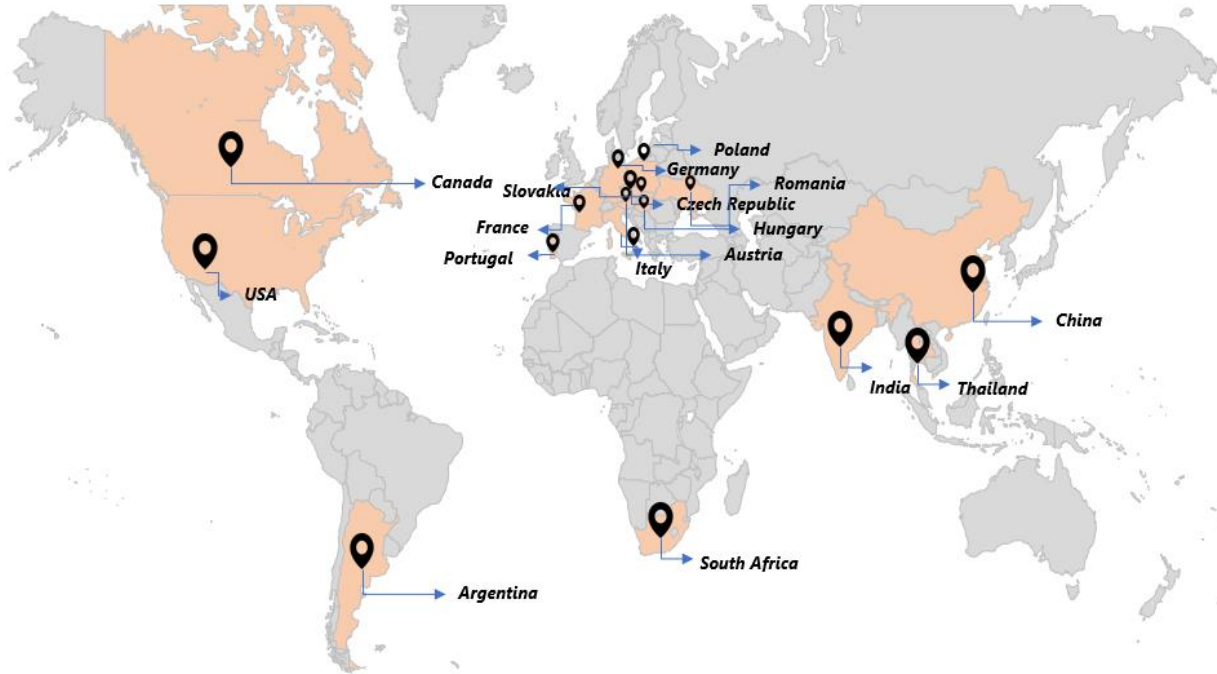

**Our operations**

**Product description**

The product description for some of the products forming part of our product portfolio is as follows:

*Bearing Rings* – Bearing Rings forms a critical part of bearings and provide a surface on which the rolling element of bearings ride. The larger ring that goes into a bore is called the outer ring, and the small ring that the shaft rides in is called the inner ring. The design and machining of the bearing rings is dependent on the expected end-use, load requirements, shape of rolling elements and other considerations. Bearing ring design, raw material specifications, machining requirements, precision sought, processing requirements and other parameters are decided by our customers, intimated to us through detailed drawing and other specifications and we are required to follow such parameters. Till date, we have offered a diverse range of hot forged and machined alloy steel bearing rings weighing from 0.01 kilograms to over 163 kilograms, and with inner diameter of 25 millimeters to outer diameter of 900 millimeters.

*Automotive components* – We manufacture a wide range of automotive components including wheel hubs, shafts and spindles, gears, etc. These components are manufactured as per our customer specifications and comprise of parts of gear box, among others.

**Our Manufacturing Facilities**

The following table depicts the various processes undertaken at our manufacturing facilities:

Unit details	Process undertaken
Unit I, Rajkot	1. Forging 2. Heat treatment

<b>Unit details</b>	<b>Process undertaken</b>
Unit II, Rajkot	3. Shot blasting 1. Forging 2. Heat treatment 3. Shot blasting 4. Cold rolling 5. Machining 6. Quality control and testing 7. Packing and dispatch
Unit III, Rajkot	1. Tool and die making 2. Shot blasting 3. Machining 4. Quality control and testing 5. Finished good warehouse 6. Packing and dispatch

### Production process

#### Engineering and designing

The new product development team reviews the inputs like drawing, customer requirements, regulatory requirements and other information associated with the product and process. The new product development team consults the marketing team for clarifications, deviations or feasibility, if any. On the basis of the inputs from marketing team, a cost sheet is prepared which is internally reviewed by the senior management team and submitted to customer. If the order is received the new product development team makes a file with estimation details, drawings, requirements and specification. The new product development team also creates a monitoring protocol of the product with respect to cost, quality, delivery and reliability to monitor the project status in coordination with cross functional team. The team prepares part drawing from customer drawing and ensures that critical characteristics, safety characteristics are addressed in part drawing. The project team prepares all tooling drawings and releases such drawings, process flow chart, control plan, and other details to concerned departments. Our team also does the production simulation to finalize the design and arrange for all required tools, software, programs, dies and raw materials for trail run. We conduct trail run as per sample size demanded by customer or decided by us and if the samples are in conformity with the requirements of the customer than the same is submitted to customer for their approval. Once it is approved then we conduct first article inspection or production part approval process run.

#### Tooling and die-making

Tooling and die making process includes tool design, inspection of incoming die material, tool and die manufacturing and testing. Tool making is done through CNC machine programming with relevant 2D drawing, 3D model and other machines. Post which, inspection of die is carried out and each die and tool is identified with unique identification number and are stored in the identified location. Dies and tools with die history card are handed over to production department as per the plan for production, planning and control.

#### Forging

Upon receipt of the raw material in a bar form as per technical parameters, a unique identification marker is allotted to each lot to ensure that there is no mixing of materials during handling. Once the lot is accepted by quality department, it is stored in a designated place and is issued to forging production lines as per production planning schedule.

Forging unit i.e. vertical forging press or high-speed hot formers is selected based on design input for a particular item to forge and the quantities to be produced. For instance, our high-speed hot formers are best suited for high volume precision components while our vertical forging lines are ideally suited for medium as well as lower volume production. For most of our forging lines, the bars are fed into the forging line in a continuous process wherein the bars are heated through electric induction heating, cut to size and forged into the requisite shape as per die profile through the hot forming units. Forging is checked for its conformity to the requirement as per control plan and drawing print.



After forging, the material is heat treated as per customer requirement like spheroidize-annealing, iso-annealing, normalising, hardening and tempering. The heat-treated product is verified for its conformity for hardness, micro structure as per sampling plan. Heat treated forging is then shot blasted to remove scale from the forging making it ready for machining.

Our Company has in the past produced hot forged and machined alloy steel bearing rings weighing from 0.01 kilograms to over 163 kilograms, and with inner diameter of 25 millimeters to outer diameter of 900 millimeters. Further, our forging lines have the following production capacity.

(in MTs.)

Sr. No.	Line	No. of Lines	2018-19			2019-20			2020-21		
			Achievable Capacity	Utilized Capacity	% of total utilization	Achievable Capacity	Utilized Capacity	% of total utilization	Achievable Capacity	Utilized Capacity	% of total utilization
1	Conventional	6	11,250	7,287	64.77%	11,250	4,638	41.23%	11,250	4,726	42.01%
2	Manyo	6	25,000	15,137	60.55%	25,000	10,940	43.76%	25,000	8,478	33.91%
3	Mitsubishi	2	8,750	4,617	52.77%	8,750	3,559	40.67%	8,750	3,313	37.86%
4	Sakamura 160 Hot Former High Speed	1	17,500	7,981	45.61%	17,500	3,920	22.40%	17,500	5,693	32.53%
5	Sakamura 120 Hot Former High Speed	1	12,500	8,216	65.73%	12,500	4,974	39.79%	12,500	6,112	48.90%
6	Hatebur-HM75 Hot Former High Speed	1	18,750	8,892	47.42%	18,750	5,596	29.85%	18,750	6,101	32.54%
7	SMS-MEER	1	9,000	2,343	26.03%	9,000	3,316	36.84%	9,000	2,868	31.87%
8	Hatebur-HM35 Hot Former High Speed	1	12,500	6,530	52.24%	12,500	4,693	37.54%	12,500	4,460	35.68%
9	Sakamura HFW-1000	1	18,750	6,009	38.46%	18,750	2,898	15.46%	18,750	4,928	26.28%

Sr. No.	Line	No. of Lines	2018-19			2019-20			2020-21		
			Achievable Capacity	Utilized Capacity	% of total utilization	Achievable Capacity	Utilized Capacity	% of total utilization	Achievable Capacity	Utilized Capacity	% of total utilization
10	Enomoto Press	1				1,563	100	6.40%	6,250	1,562	24.99%
11	Eumoco	1							2,250	220	9.78%
	<b>Total</b>	<b>22</b>	<b>1,34,000</b>	<b>67,013</b>	<b>50.01%</b>	<b>1,40,250</b>	<b>44,633</b>	<b>32.92%</b>	<b>1,44,750</b>	<b>48,461</b>	<b>33.48%</b>

## Heat Treatment

We undertake heat treatment under the following categories:

### *Normalizing*

Normalizing is a technique used in forging to provide uniformity in grain size throughout an alloy metal which helps improve machinability of the components.

### *Spheroidize-annealing*

Spheroidize annealing is a type of annealing process involving controlled heating and cooling to produce a microstructure consisting of spherical (spheroidal) carbides in a ferrite matrix. Spheroidize-annealing is most often used to improve machinability and to produce a uniform microstructure.

### *Iso-annealing*

Iso-annealing is a rather generalized term that consists of heating a metal to beyond the upper critical temperature and then cooling very slowly and at a rate that will produce a refined microstructure. The rate of cooling for annealing is typically slow. Iso-annealing is most often used to soften a metal to improve machinability and to produce a uniform microstructure.

### *Hardening and tempering*

Tempering is used to develop the required combination of hardness, strength, and toughness or to relieve the brittleness of fully hardened steels. The combination of quenching and tempering in forging is important to make tough parts.

### *Case carburising*

This is a heat treatment process that produces a surface which is resistant to wear, while maintaining toughness and strength of the core. This treatment is applied to low carbon steel parts after machining, as well as high alloy steel bearings, gears, and other components.

### *Induction hardening*

Induction hardening is a process used for the surface hardening of machined parts. The parts to be heat treated are placed inside a water-polymer cooled copper coil and then heated above their transformation temperature by applying an alternating current to the coil.

## Cold Rolling

Cold rolling is a metal forming process in which the forged and annealed components are passed through one or more pairs of rolls to reduce the thickness, increase diameter, to make the thickness uniform, to impart desired mechanical properties and improve yield in manufacturing process. The amount of strain introduced determines the hardness and other material properties of the finished product.

## Machining

### *Pre Machining*

In this process, forged parts are pre-machined on conventional lathe and manually operated CNC turning centres.

This helps improve productivity of our machining centres and helps optimize our costs. We use third party vendors to provide pre-machining services as required by us.

### *CNC Turning*

CNC turning is a machining process used to make cylindrical parts, where the cutting tool moves in a linear fashion while the work piece rotates. Commonly performed with a lathe, turning reduces the diameter of the part, typically to a specified dimension, and produces a smooth part finish. A turning centre is a lathe with a computer numerical control. CNC turning centers can also perform a variety of operations including grooving, facing, threading, drilling, boring.

### *Vertical Machining Centres (“VMC”)*

VMC relies on rotary cutters to remove metal from a work piece. VMC employs a spindle with a vertical orientation. With a vertically oriented spindle, tools stick straight down from the tool holder, and often cut across the top of a work piece. VMC units can perform a variety of operations including milling, facing, threading, drilling, boring. As on date of this RHP, our machining capabilities are as below:

<b>S. No.</b>	<b>Machine manufacturer</b>	<b>Number of machines</b>
1.	Brother Industries Ltd	5
2.	ACE Micromatic Group	1
3.	Trident Machinery Co. Ltd	3
4.	Jyoti CNC Automation Ltd	1
5.	HAAS Automation	1

### *Quality control and testing*

The quality of our products and customer satisfaction are of significant importance to our business and we believe in adhering to the prescribed standards of quality for our products. We ensure that our products undergo rigorous quality checks throughout the entire production chain to ensure that optimum standard requirements expected by our customers are continuously met. We exercise stringent prevention-based quality control checks consisting of incoming, in-process and outgoing quality controls and have a team of approximately 423 employees in quality control department. Over a period of time, we have developed robust testing and quality assurance procedures which are imbibed in our employees from the plant level to senior management through a quality system manual, which is updated from time to time to keep pace with changes in standards, regulations, technological advancements and any particular requirements of the customer. Our quality system manual sets out detailed processes for product audit and quality rating, which are carried out on a periodical basis. The quality check parameters are laid down to ensure adherence to defined process and product specifications.

Our customers expect us to undertake extensive product approvals and/or certification process. Further, our Company is in the process of renewing its IATF 16949 and ISO 9001 certifications which pertains to quality management systems and such renewal has been recommended by TUV NORD - Germany. Many of our customers also perform their own quality checks to ensure that our products meet their demands and comply with the requirements. Our quality control programs at most of our production sites involve subjecting the manufacturing processes and quality management systems to periodic reviews and observation for various periods of time.

### **Sales and marketing**

Our sales and marketing network is a team comprising of professionals who work under the supervision of our Chairman and Managing Director. We supply our components directly to the OEMs, Tier-I and Tier-II suppliers, bearing companies and other customers. We leverage our relationships with our existing customers to procure repeat orders from them as well as invitations to supply components for their new product programs. Based on our credentials and recognitions awarded to us by our valued existing customers, we approach new customers for business. Our management has flexibility to accept customers’ specific requirements while negotiating and discussing development of new products. As on June 30, 2021, our sales and marketing team consists of 44 employees.

### **Raw materials**

The principal raw material that we use in the manufacturing of our products comprises of carbon steel, alloy steel and stainless steel. We source our raw materials from sources which have been pre-approved by our customers which

includes imports as well as domestic steel companies. Further, in a significant part of our contracts with customers, we enter into arrangement to pass-on the changes in raw material prices to our customers.

### Utilities

We source most of our electricity requirements for our manufacturing facilities from state electricity board. We also self-cater to part of our needs through solar electricity generators, which together have an installed capacity of 1.58 MW. Further, the company operates wind mills with a combined installed capacity of 8.75 MW and such electricity generated through wind mills is supplied to the state electricity board at a pre-agreed price.

### Shipments

Our products are shipped to our customers both domestically as well as to our international customers including those in United States of America and in European countries such as Germany, France, Italy, and Czech Republic, and Thailand. While in a few cases, our customers directly pick up the goods from our facilities, in most instances, we are responsible to ensure timely delivery of components to our customers. The mode of transportation for a particular shipment is dependent on the urgency, size and value of the order. Our domestic shipments use different modes of transportation including road transportation to supply our customers within their required deadlines. We manage the transportation requirements for such domestic or inbound freight through third party service providers. Where a shipment is outbound overseas, we use different modes of transportation including road and sea transportation. We also utilize third party freight forwarders who contract with the relevant ocean carriers on our behalf, and engage with service providers to provide support on our transportation requirements. These third party service providers ensure our transportation rates are competitive and that our transportation carriers are performing as required.

We also work with certain third party service providers for warehousing of our products at locations which are closer to the plants of our customers. Such service providers provide us with multiple services including warehousing, material handling and transportation of our products.

### Human resources

As of June 30, 2021, our business had approximately 1,815 permanent employees and 654 workers on contract basis. Approximately 481 of our employees have professional educational backgrounds such as engineering, chartered accountancy and business administration, among others. The breakdown of our employees in our business by function is summarized in the following table:

<b>Function</b>	<b>Number of employees, as of June 30, 2021</b>
Production	1,056
Quality	423
Finance	15
Human Resources	24
Sales and Marketing	44
Procurement	21
Others	232
<b>Total</b>	<b>1,815</b>

We also engage contractors to provide us contract labour from time to time. As on date of this RHP, we have engaged 18 such contractors.

We are committed to maintaining high standards of workplace health and safety and we regard the safeguarding of such interests as one of our most fundamental responsibilities as an employer. Our Company has also obtained ISO 45001 certifications which pertains to occupational health and safety of our operations. We see safety as both a right and a responsibility for all employees and we aim to become a zero-accident organisation. Any mishaps or accidents at our facilities or any emission or leakage from our factory could lead to personal injury, property damage, production loss, adverse publicity and legal claims. It is therefore important that we maintain the occupational health and safety certification in relation to our management of the safety of our people and property. Accordingly, we maintain a health, safety and environment policy.

In addition to the safety of our employees, we invest significant resources in training for skill-enhancement of our employees. We intend to continue to focus on attracting and retaining high quality talent. In particular, we plan to continue to further build our presence and consolidate our position as an employer of choice in India.

### **Intellectual property**

Our Company does not own any intellectual property as of the date of filing of this RHP.

### **Corporate social responsibility**

Our commitment to corporate social responsibility is demonstrated in how we conduct our business by providing a safe workplace for our employees, minimising any impact to the environment, being a positive corporate citizen in the communities in which we operate and prioritising ethical business practices at all our locations. Each of these principles influence our strategy planning, decision making process and daily operations. Our Company obtained ISO 18001 certification which pertains to environmental management system.

Our external corporate social responsibility programmes include supporting programs geared towards promoting healthcare, education, environment sustainability and animal welfare. Our CSR expenses for Fiscals 2021, 2020 and 2019 were ₹ 16.80 million, ₹ 8.59 million and ₹ 7.16 million respectively out of which the actual amounts spent by the Company were ₹ 1.70 million, ₹ 8.59 million and ₹ 7.16 million, respectively, which amounted to a shortfall of 89.88%, 52.20% and 48.58% of the gross amount required to be spent by the Company during the year on corporate social responsibility related activities remained unutilized.

### **Insurance**

Our operations are subject to various risks inherent in the manufacturing industry as well as theft, natural disasters, spread of communicable diseases, acts of terrorism and other unforeseen events. We maintain insurance cover for our properties, and our policies cover, among others, protection from fire, special perils, burglary, machinery breakdown, public liability, product liability, product recall and financial loss. We also maintain a variety of employee insurance policies such as workmen compensation policy, and group care policy. We also maintain insurance for our directors' and officers' liability as well as marine insurance policy in relation to movement of our products.

Our insurance coverage is in accordance with industry customs, including the terms and scope of the coverage provided by such insurance. Notwithstanding the above, our policies are nonetheless subject to standard limitations. For example, in the case of business interruption, limitations apply with respect to the length of the interruption covered and the maximum amount that can be claimed. Therefore, insurance might not necessarily cover all losses incurred by us and we cannot provide any assurance that we will not incur losses or suffer claims beyond the limits of, or outside the relevant coverage of, our insurance policies. See "*Risk Factors – Our insurance coverage may not be sufficient or may not adequately protect us against all material hazards, which may adversely affect our business, results of operations, cash flows and financial condition.*" on page 32 for further information.

### **Competition**

The industry we operate in is competitive and we face competition both domestically and internationally. The key factors of competition are manufacturing infrastructure, quality, cost, delivery capabilities, customer relationship, certifications and management. For details of our competitors, please see "*Industry Overview*" beginning on page 95.

### **Properties**

Our registered office is located at B/h. Glowtech Steel Private Limited, Gondal Road, Kotharia, Rajkot, Gujarat 360 004] and our corporate office is located at Near Kotharia Railway Crossing, opposite Hotel Krishna Park, Gondal Road, Kotharia, Rajkot, Gujarat 360 004. The land on which our registered and corporate office is located is owned by our Company. Further, our Company runs its operations out of three manufacturing facilities which are owned by our Company, details of which are listed below:

<b>S. No</b>	<b>Address</b>	<b>Owned or leased</b>
1.	Unit I, B/h. Glowtech Steels, Gondal Road, Kotharia, Rajkot-360 004	Owned
2.	Unit II, Near Kotharia Railway Crossing, opposite Hotel Krishna Park, Gondal Road, Kotharia, Rajkot, Gujarat 360 004	Owned
3.	Unit III, Near Kotharia Railway Crossing, opposite Hotel Krishna Park, Gondal Road, Kotharia, Rajkot, Gujarat 360 004	Owned

These parcels are pledged in favour of CDR Group Lenders. For further details, please see “History and Certain Corporate Matters - Defaults or rescheduling/restructuring of borrowings” on page 133. In addition to the above, our Company also owns certain other parcels of land, including for the purposes of setting up a solar plant at Taluka Muli (Gujarat), and for the operation of windmills at Taluka Vanku (Gujarat). Further, our windmills are also situated at Bhogat and Lamba sites (Gujarat), which are on premises that have respectively been leased and sub-leased by us from third parties through lease or leave and license or tenancy arrangements. Our Company has unutilized land area of 32,071.44 square metres at Rajkot which can be utilized for any further expansion.



## KEY REGULATIONS AND POLICIES

*The following is an overview of certain sector-specific Indian laws and regulations which are relevant to the operations of our Company. The information detailed in this chapter has been obtained from publications available in public domain. The description of laws and regulations set out below is not exhaustive but indicative and is only intended to provide general information to investors and is neither designed nor intended to be a substitute for professional legal advice. The statements below are based on the current provisions of Indian law, and the judicial, regulatory and administrative interpretations thereof, which are subject to change or modification by subsequent legislative and regulatory actions, administrative or judicial decisions.*

### KEY REGULATIONS IN INDIA

#### *Key Industry Regulations*

Our Company deals in the manufacturing of automotive components and bearing rings. For the purpose of the business undertaken by our Company, our Company is regulated by various general and sector-specific laws and regulations in India and is accordingly required to obtain certain licenses and approvals under the prevailing laws and regulations as applicable. The industry is regulated in India by the following regulations and policies:

#### *Regulation of the automotive components manufacturing industry*

##### *The National Auto Policy*

The National Auto Policy, 2002, as amended ("**National Auto Policy**") was introduced by the Department of Heavy Industries, Ministry of Heavy Industries and Public Enterprises, GoI in March 2002, with the aim, among others, (i) to promote the automotive industry as a global source for auto components, (ii) to enable open trade at minimal risk to the Indian economy and local industry, (iii) to modernise the industry and (iv) to develop domestic safety and environmental standards at par with international standards. In February 2018, the Department of Heavy Industries, Ministry of Heavy Industries and Public Enterprises, GoI released a Draft National Auto Policy, 2018 that seeks to address the key issues that are hindering the different parts of the automotive value chain and are impacting the industry as a whole. It is intended to support and supplement the framework laid down in the Automotive Mission Plan 2016-2026.

##### *Automotive Mission Plan, 2016-2026*

The Ministry of Heavy Industries and Public Enterprises, GoI released the Automotive Mission Plan 2016-26 ("**AMP**") in September 2015. The objective of the AMP, among others, is for the automotive industry to aid the "Make in India" and "Skill India" programmes of the GoI, to provide consumers with more choice and access to options for mobility with focus on environmental protection and affordability through both public and personal transport options, and to increase the net exports of the Indian automotive industry. It is aimed at multiple stakeholders in India and overseas, with an intent to convey the needs of the Indian automotive industry comprising of the automotive vehicle manufacturers, the auto-component manufacturers and tractor manufacturers who operate in India.

#### *Regulation of the manufacturing sector*

##### **The Factories Act, 1948 ("Factories Act")**

The primary central legislation governing the manufacturing sector is the Factories Act. It applies to industries in which 10 or more workers are employed on any day of the preceding 12 months in any manufacturing process carried out with the aid of power, or 20 or more than 20 workers are employed in the manufacturing process being carried out without the aid of power. Each state government has enacted rules in respect of the prior submission of plans and their approval for the establishment, registration and licensing of factories. The Factories Act requires that the occupier of a factory, i.e., the person who has ultimate control over the affairs of the factory and in the case of a company, any one of the directors, must ensure the health, safety and welfare of all workers especially in respect of safety and proper maintenance of the factory, such that it does not pose health risks, the safe use, handling, storage and transport of factory articles and substances, provision of adequate instruction, training and supervision to ensure workers' health

and safety, cleanliness and safe working conditions. The Factories Act also provides for fines to be paid and imprisonment of the manager of the factory in case of any contravention of the provisions of the Factories Act.

### **Duty Drawback Scheme**

The duty drawback scheme is an option available to exporters. Under this scheme, exporters of goods are allowed a refund of money to compensate them for refund of indirect taxes paid on the inputs used in the products exported by them. The admissible duty drawback amount is paid to exporters by depositing it into their nominated bank account. Section 75 of the Customs Act, 1962 empowers the Central Government to grant such duty drawback. The Customs and Central Excise Duties Drawback Rules, 2017 were made effective from October 1, 2017. With this, the earlier Customs, Central Excise Duties and Service Tax Drawback Rules, 1995 ceased to operate.

### **RoDTEP Scheme**

The Scheme for Remission of Duties and Taxes on Exported Products (“**RoDTEP Scheme**”), as approved by the Cabinet Committee on Economic Affairs on March 13, 2020, would act as the successor to the Merchandise Exports from India Scheme. Certain taxes/duties/levies which are outside GST, and are not refunded for exports, such as, VAT on fuel used in transportation, Mandi tax, duty on electricity used during manufacturing etc. would be covered for reimbursement under the RoDTEP Scheme. The rates under the RoDTEP Scheme are yet to be notified.

## **ENVIRONMENTAL LEGISLATIONS**

### **Environment Protection Act, 1986 (“Environment Act”)**

The Environment Act is an umbrella legislation designed to provide a framework for the Central Government to coordinate activities of various state and central authorities established under previous environmental laws. The Environment Act states that no person carrying on any industry, operation or process shall discharge or emit or permit to be discharged or emitted any environment pollutants in excess of prescribed standards. Further, it empowers the Central Government to make rules for various purposes, including prescribing: (i) the standards of quality of air, water or soil for various areas and purposes; (ii) the maximum allowable limits of concentration of various environmental pollutants (including noise) for different areas; (iii) the procedures and safeguards for the prevention of accidents which may cause environmental pollution and remedial measures for such accidents.

### **Environment (Protection) Rules, 1986 (“Environment Rules”)**

The Environment Rules were notified by the Central Government, in exercise of its powers under the Environment Act. Pursuant to the Environment Rules, every person who carries on an industry, operation or process requiring consent under Water (Prevention and Control of Pollution) Act, 1974 or Air (Prevention and Control of Pollution) Act, 1981, shall submit to the concerned Pollution Control Board (“**PCB**”) an environmental statement for that financial year in the prescribed form.

### **Air (Prevention and Control of Pollution) Act, 1981 (“Air Act”)**

The Air Act mandates that any individual, industry or institution responsible for emitting smoke or gases by way of use as fuel or chemical reactions, obtains consent from the PCB prior to commencing any activity. The consent may be conditional on certain specifications like installation of pollution control equipment.

### **Water (Prevention and Control of Pollution) Act, 1974 (“Water Act”)**

Under the provisions of the Water Act, any individual, industry or institution discharging industrial or domestic wastewater or establishing any treatment or disposal system or the using of any new or altered outlet for the discharge of sewage is required to obtain the consent of the applicable state PCB, which is empowered to establish standards and conditions that are required to be complied with. The consent to operate is granted for a specific period after which the conditions stipulated at the time of granting consent are reviewed by the state PCB. Even before the expiry of the consent period, the state PCB is authorized to carry out random checks on any industry to verify if the standards prescribed are being complied with by the industry. In the event of non-compliance, the state PCB after serving notice to the concerned industry may withdraw water supply to the industry or cause magistrates to pass injunctions to restrain

such polluters.

### **Hazardous Wastes (Management, Handling and Transboundary Movement) Rules, 2016 (“Hazardous Wastes Rules”)**

The Hazardous Wastes Rules impose an obligation on every occupier of an establishment generating hazardous waste to deploy safe and environmentally sound practices of management of hazardous wastes in such establishment. The hazardous wastes generated in the establishment of an occupier are required to be sent or sold to an authorised actual user or to be disposed of in an authorised disposal facility. Every person engaged, *inter alia*, in the generation, processing, treatment, packaging, storage and destruction of hazardous waste is required to obtain an authorization from the relevant state PCB for activities including generating, handling, collecting, receiving, recycling, disposing, storing and treating the hazardous waste.

## **LABOUR LAWS AND OTHER LAWS**

### **Labour Laws**

Depending on the nature of work and number of workers employed at any workplace, various labour related legislations may apply to us. Further, certain other laws and regulations that may be applicable to our Company in India including but not limited to the following:

- The Employees’ Provident Funds and Miscellaneous Provisions Act, 1952;
- The Industrial Disputes Act, 1947;
- The Employees’ State Insurance Act, 1948;
- The Public Liability Insurance Act, 1991;
- The Maternity Benefit Act, 1961;
- The Contract Labour (Regulation and Abolition) Act, 1970;
- The Sexual Harassment of Women at Workplace (Prevention, Prohibition and Redressal) Act, 2013;
- The Equal Remuneration Act, 1976
- The Employee’s Compensation Act, 1923;
- The Minimum Wages Act, 1948;
- The Payment of Wages Act, 1936;
- The Payment of Gratuity Act, 1972;
- The Payment of Bonus Act, 1965;
- The Industrial Employment (Standing Orders) Act, 1946;
- Foreign Exchange Management Act, 1999 and Foreign Trade (Development & Regulation) Act, 1992;

In order to rationalize and reform labour laws in India, the Government of India in the process of implementing: (i) The Industrial Relations Code, 2020 received the assent of the President of India on September 28, 2020 and it proposes to subsume three existing legislations, namely, the Industrial Disputes Act, 1947, the Trade Unions Act, 1926 and the Industrial Employment (Standing Orders) Act, 1946; (ii) The Code on Wages, 2019 received the assent of the President of India on August 8, 2019 and proposes to subsume four existing laws namely, the Payment of Wages Act, 1936, the Minimum Wages Act, 1948, the Payment of Bonus Act, 1965 and the Equal Remuneration Act, 1976; (iii) The Occupational Safety, Health and Working Conditions Code, 2020 received the assent of the President of India on September 28, 2020 and proposes to subsume certain existing legislations, including the Factories Act, 1948, the Contract Labour (Regulation and Abolition) Act, 1970, the Inter-State Migrant Workmen (Regulation of Employment and Conditions of Service) Act, 1979 and the Building and Other Construction Workers (Regulation of Employment and Conditions of Service) Act, 1996; (iv) The Code on Social Security, 2020 received the assent of the President of India on September 28, 2020 and it proposes to subsume certain existing legislations including the Employee’s Compensation Act, 1923, the Employees’ State Insurance Act, 1948, the Employees’ Provident Funds and Miscellaneous Provisions Act, 1952, the Maternity Benefit Act, 1961, the Payment of Gratuity Act, 1972, the Building and Other Construction Workers’ Welfare Cess Act, 1996 and the Unorganised Workers’ Social Security Act, 2008.

## Securities Laws

The listing of securities on recognized stock exchanges in India is regulated by applicable Indian laws including the Companies Act, 2013, as amended (“**Companies Act**”) SCRA, SCRR, the SEBI Act, various regulations issued by SEBI including the Securities and Exchange Board of India (Listing Obligations and Disclosure Requirements) Regulations, 2015, as amended (the “**Listing Regulations**”) and the listing agreements executed between listed companies and stock exchanges. A listed entity or any other person who contravenes the Listing Regulations shall, in addition to liability in terms of securities laws, be liable for action by the stock exchanges, including imposition of fines, suspension of trading, etc. A recognized stock exchange is empowered to suspend trading of or dealing in a listed security for breach of certain of the company's obligations under such Listing Regulations subject to the company receiving prior notice of such intent of the stock exchange. The Securities Appellate Tribunal, after giving the stock exchange an opportunity to be heard, has the power to vary or set aside the decision of the stock exchange in this regard. Accordingly, once listed, the following material securities laws will be applicable to our Company, in addition to other applicable securities rules and regulations:

### *Minimum Level of Public Shareholding*

In terms of the SCRR and the Listing Regulations, all listed companies are required to ensure that their minimum level of public shareholding remains at or above 25%. In this regard, SEBI has provided several mechanisms to comply with this requirement. Further, where the public shareholding in a listed company falls below 25% at any time, such company is required to bring the public shareholding to 25% within a maximum period of 12 months from the date of such fall in the manner specified by the SEBI.

### *Insider Trading Regulations*

The Securities and Exchange Board of India (Prohibition of Insider Trading) Regulations, 2015, as amended (the “**Insider Trading Regulations**”) have been notified by SEBI to amongst other things, prohibit and penalize insider trading in India and prohibit dealing in the securities of a listed company when in possession of unpublished price sensitive information (“**UPSI**”).

The Insider Trading Regulations also impose certain restrictions on the communication of UPSI relating to a company or securities listed or proposed to be listed. In terms of the Insider Trading Regulations, (i) no insider shall communicate, provide or allow access to any UPSI relating to such companies and securities to any person including other insiders; and (ii) no person shall procure or cause the communication by any insider of UPSI relating to such companies and securities, except in furtherance of legitimate purposes, performance of duties or discharge of legal obligations. However, UPSI may be communicated, provided or allowed access to or procured, under certain circumstances specified in the Insider Trading Regulations.

The Insider Trading Regulations define the term “unpublished price sensitive information” to mean any information, relating to a company or its securities, directly or indirectly, that is not generally available which upon becoming generally available, is likely to materially affect the price of its securities and ordinarily includes but not restricted to information relating to the following: (a) financial results; (b) dividends; (c) change in capital structure; (d) mergers, de-mergers, acquisitions, de-listings, disposals and expansion of business and such other transactions; and (e) changes in key managerial personnel. Further, in terms of the Insider Trading Regulations, “generally available information” is defined as information that is accessible to the public on a non-discriminatory basis. An “insider” means any person who is i) a connected person; or ii) in possession of or having access to unpublished price sensitive information. The term “connected person” means any person who is or has during the six months prior to the concerned act been associated with a company, directly or indirectly, in any capacity, including by reason of frequent communication with its officers or by being in any contractual, fiduciary or employment relationship or by being a director, officer or an employee of the company or holding any position, including a professional or business relationship between himself and the company, whether temporary or permanent, that allows such person, directly or indirectly, to have access to unpublished price sensitive information or is reasonably expected to allow such access.

The Insider Trading Regulations make it compulsory for listed companies and certain other entities (including fiduciaries and intermediaries) that are required to handle UPSI in the course of business operations to establish (i) an internal code of practices and procedures for fair disclosure of UPSI; (ii) an internal code to regulate, monitor and report trading by designated persons and immediate relatives of designated persons; and (iii) a policy for procedures

to be adopted by a company in case of any leak of UPSI. There are also initial and continuing shareholding disclosure obligations under the Insider Trading Regulations.

### ***Takeover Regulations***

Disclosure and mandatory bid obligations for listed Indian companies under Indian law are governed by the specific regulations in relation to substantial acquisition of shares and takeover. After listing on the stock exchanges, the provisions of the Securities and Exchange Board of India (Substantial Acquisition of Shares and Takeovers) Regulations, 2011 (the “**Takeover Regulations**”) will apply to our Company, which provide specific regulations in relation to substantial acquisition of shares and takeovers. Once the equity shares of a company are listed on a stock exchange in India, the provisions of the Takeover Regulations will apply to any acquisition of the company’s shares/voting rights/control. The Takeover Regulations prescribes certain thresholds or trigger points in the shareholding that a person or entity (along with persons acting in concert with such person or entity) has in the listed Indian company, which give rise to certain obligations on the part of the acquirer. Acquisition of shares or voting rights up to a certain threshold mandate specific disclosure requirements, while acquisitions (direct or indirect, along with persons acting in concert with such acquirer) crossing particular thresholds may result in the acquirer having to make an open offer for the shares of the target company.

### **Others**

In addition to the above, our Company is also required to comply with the provisions of the Companies Act and rules framed thereunder and other applicable statutes imposed by the Centre or the State Government. Various central and state tax laws are applicable to our Company. In addition to the above, the Indian Contract Act, 1872, the Specific Relief Act, 1963, the Sale of Goods Act, 1930 shall be applicable to our Company.

## HISTORY AND CERTAIN CORPORATE MATTERS

### Brief history of our Company

Our Company started its business under the partnership firm by the name of 'Rolex Industries' by two of our Promoters, Rupesh Dayashankar Madeka and Manesh Dayashankar Madeka in 1977-1978. The partnership deed was executed at Rajkot on April 26, 1988 and Jiten Dayashankar Madeka was admitted as partner in Rolex Industries. Further, on October 10, 1989, Ashok Dayashankar Madeka and Pinakin Dayashankar Madeka were admitted as partners in Rolex Industries and on December 31, 2002, Bhautik Dayashankar Madeka, Paresh Dayashankar Madeka, Mihir Rupeshkumar Madeka, Hemal Paresh Madeka and Sanjay Bhagwanji Bole were admitted as partners in Rolex Industries.

The partnership firm was, thereafter, converted into a joint stock company under the Companies Act, 1956, in the name of 'Rolex Rings Private Limited', and a certificate of incorporation dated February 13, 2003, was issued by the RoC. The name of our Company was further changed to Rolex Rings Limited upon conversion to a public limited company pursuant to the special resolution dated February 19, 2021 passed by the Shareholders of our Company and a fresh certificate of incorporation was issued by the RoC on March 10, 2021.

### Changes in the registered office

There has been no change in the registered office of our Company since the date of its incorporation. However, in order to fix the spelling error in the address of the registered office of our Company as appearing on the website of the Ministry of Corporate Affairs, our Board passed a circular resolution dated June 15, 2017 to correct the spelling error in address of the registered office of our Company and, thereafter, filed e-Form INC-22 with the RoC.

The details of the correction in the address of the registered office of our Company are as follows:

Effective Date	Details of Change
June 15, 2017	The address of the registered office of our Company was modified from B/h. Glowtech Steel Private Limited, Gondla Road, Kotharia, Rajkot – 360004, Gujarat to B/h. Glowtech Steel Private Limited, Gondal Road, Kotharia, Rajkot – 360004, Gujarat.

### Our main objects

The main objects of our Company as contained in our MoA are:

- To carry out business as manufacturers, exporters, dealers, agents, hirers, repairers, cleaners, of forgings, forged products, castings, metal forming, treatment of forgings and castings, machining and metal working of forgings and castings and in lines allied to the same.*
- To carry on the business of electricity generation by installing wind mills, hydro-electric generators, thermal power stations, gas turbine, diesel generating sets and any other mode of generation of electricity for captive consumption or for sale to other parties.*

The main object clause and matters which are necessary for furtherance to the main objects contained in the MoA enable our Company to undertake its existing activities.

### Amendments to our MoA

Set out below are the amendments to our MoA in the last ten years:

Date of Shareholders' resolution	Nature of amendment
September 28, 2013	Clause V of the MoA was amended to reflect the reclassification and sub-division of the authorized share capital of our Company from ₹ 350,000,000 comprising of 25,025,000 Equity

Date of Shareholders' resolution	Nature of amendment
	shares of ₹ 10 each and 2,850 CCPS of ₹ 35,000 each to ₹ 350,000,000 comprising of 25,025,000 Equity Shares of ₹ 10 each and 9,975,000 NCRPS of ₹ 10 each.
December 1, 2014	Clause V of the MoA was amended to reflect an increase in the authorised share capital of our Company from ₹ 350,000,000 comprising of 25,025,000 Equity Shares of ₹ 10 each and ₹ 9,975,000 NCRPS of ₹ 10 each to ₹ 410,000,000 divided into 25,025,000 Equity Shares of ₹ 10 each and 15,975,000 NCRPS of ₹ 10 each.
February 20, 2018	Clause V of the MoA was amended to reflect an increase in the authorized share capital of our Company from ₹ 410,000,000 divided into 25,025,000 Equity Shares of ₹ 10 each and 15,975,000 NCRPS of ₹ 10 each to ₹ 510,000,000 divided into 35,025,000 Equity Shares of ₹ 10 each and 15,975,000 NCRPS of ₹ 10 each.
February 19, 2021	<p>Clause I of the MoA was amended to reflect the change in name of our Company from Rolex Rings Private Limited to Rolex Rings Limited.</p> <p>Clause III [B] was amended to transfer all the incidental &amp; ancillary objects and other objects under a single head i.e. "Matters which are necessary for furtherance of the objects specified in clause III[A]" and modification of objects in line with the business and with provisions of the Companies Act, 2013.</p> <p>Clause V of the MoA was amended to reflect an increase in the authorized share capital of our Company from ₹ 510,000,000 divided into 35,025,000 Equity Shares of ₹ 10 each and 15,975,000 NCRPS of ₹ 10 each to ₹ 560,000,000 divided into 35,025,000 Equity Shares of ₹ 10 each and 15,975,000 NCRPS of ₹ 10 each and 5,000,000 OCRPS of ₹ 10 each.</p>

### Total number of Shareholders of our Company

As on the date of this Prospectus, our Company has 12 Shareholders.

For further details, see "Capital Structure" on page 64.

### Key awards, accreditations, and recognition

The table below sets forth some of the awards and accreditations received by our Company:

Calendar Year	Awards and Accreditations
2021	Q1 Preferred Quality Status - Ford
2019	Supplier Quality Excellence Award – General Motors
2018	Excellence in New Product Development – Timken
2018	Supplier Quality Excellence Award – General Motors
2016	Excellence in Technology Advancement by Timken powered by VRIDDHI
2014	Certificate of Supplier Quality for fulfilling the quality assurance compliance by Hyundai Motors India Ltd.
2014	GM Supplier Quality Excellence Award
2011	Excellence in Technology – Timken
2011	Excellence in Cost and Productivity – Timken

### Major events and milestones

The table below sets forth some of the major events in the history of our Company:

Calendar Year	Details
1977	Commencement of business in the name of Rolex Industries
1978	Formation of partnership firm in the name of Rolex Industries
1988	Started manufacturing of forging and forged products
1989	Obtained Importer-Exporter code for export of business
1991	Commissioning of Unit 1

Calendar Year	Details
2003	Purchase of Sakamura model HBP-160
2003	Conversion of partnership firm into Company
2007	Purchased 6 Manyo 600 tons Auto Forging Press
2007	Investment by Rivendell PE LLC
2007	Purchase of (a) Hatebur Hotmatic – HM75XL Hot Former, (b) Sakamura Model HBP – 120SS
2007	Availed registration of central excise for Unit 2
2010	Purchase of SMS MEER Ring Rolling line
2011	Purchase of Hatebur-Hotmatic@ HM 35 Machine
2014	Setting up of Unit 3
2017	Purchase of Sakamura Model: HFW-1000-4 Hot Former
2018	Purchase of Servomoto Driven Screw Press 16000kN from Enomoto Machine Co. Limited
2019	Crossed ₹9,000 million in revenue in Fiscal 2019.

### Time/cost overrun

We have not experienced any instances of time/cost overrun in our business operations.

### Defaults or rescheduling/restructuring of borrowings

Except as disclosed below, there have been no instances of defaults or rescheduling/restructuring of borrowings with financial institutions or banks:

1. Our Company approached its lenders to restructure the debts and accordingly we have been referred to the Corporate Debt Restructuring forum for the restructuring of our debt (“**CDR**”). The CDR forum approved the restructuring of debt on January 9, 2013 and we were advised to implement the CDR package within a maximum period of 120 days (“**CDR Package**”). To give effect to the CDR Package, our Company entered into a master restructuring agreement (“**MRA**”) dated March 28, 2013 with Corporation Bank, Oriental Bank of Commerce, Union Bank of India, Bank of Baroda, Bank of India, Indian Overseas Bank (collectively, “**Consortium Lenders**”) wherein the Consortium Lenders have restructured the debt. The restructured term debt amounted to ₹ 4,870.20 million out of which ₹ 1,358.90 million to be repaid by March 31, 2020 and balance ₹ 3,511.30 million to be repaid by March 31, 2022. As on March 31, 2021, the percentage of the restructured term debt still due is 6.89% and amounted to ₹ 335.74 million. Further, the Consortium Lenders assessed fund based working capital limit to ₹ 1,490.90 million and ₹ 1,805.70 million for the FY 2013 and 2014 respectively and assessed non-fund based working capital limit to ₹ 822.00 million & ₹ 939.10 million for the FY 2013 and 2014 respectively (“**Facilities**”). On November 22, 2013 a supplemental master restructuring agreement (together with MRA the “**Restructuring Agreements**”) was entered into amongst our Company, Consortium Lenders and IDBI Bank Limited (“**Non-Consortium Lender**” and together with Consortium Lenders, “**CDR Group Lenders**”). Further, in terms of the Restructuring Agreements, the Facilities are secured by the hypothecation of the entire fixed and current assets of our Company, pledge on the shareholding of our Promoters and certain members of our Promoter Group including requirement of creation of pledge on any new securities issued to Promoters and certain members of our Promoter Group, personal guarantees issued by our Promoters and certain members of our Promoter Group, and corporate guarantees issued by members of our Promoter Group, namely, Rolex Properties Private Limited and Madeka Properties Private Limited.

Apart from the above, the Restructuring Agreements confers certain rights on the CDR Group Lenders, including, right to appoint nominee directors to our Board, acquiring security over any immoveable properties acquired by the Company, right to be notified regarding any proposed change in the nature and scope of the business of the Company or modification/ cancellation of any of the agreements with machinery suppliers etc., right to appoint any entity engaged in the technical management or consultancy business to inspect and examine the working of the Company and its manufacturing facilities, and right of recompense. Further, without the prior consent of the CDR Group Lenders, the Company cannot undertake any new projects, issue loans, debentures, pay commissions, create any subsidiaries, or joint ventures or pay any dividends. In the event our Company defaults on the payment obligations under the Restructuring Agreements, the CDR Group Lenders have *inter-alia* the (i) right to enter upon and take possession of our assets, transfer the assets of our Company by way of lease or leave and license, (ii) right to convert the whole of the outstanding amount of



the borrowings or 20% of rupee equivalent of the defaulted amount into fully paid up Equity Shares of our Company, (iii) right to review the management set-up of our Company and require our Company to restructure as considered suitable by the CDR Group Lenders, (iv) right to modify or terminate any existing selling/ purchasing arrangements, and (v) remove the whole time directors of our Company and appoint nominee directors who can exercise such powers and duties as approved by the CDR Group Lenders.

Pursuant to the Restructuring Agreements, our Promoters and members of the Promoter Group have entered into a supplemental pledge agreement dated March 28, 2013 with Consortium Lenders, pursuant to which our Promoters and members of our Promoter Group have pledged 13,066,667 Equity Shares in favour of the Consortium Lenders. Further, through a pledge agreement dated September 24, 2018, between our Promoters and certain members of the Promoter Group and the Consortium Lenders, 13,605,863 NCRPS held by our Promoters and certain members of our Promoter Group had pledged in favour of the Consortium Lenders. Pursuant to the Waiver Letters, the Consortium Lenders have removed pledge on certain number of Equity Shares to ensure compliance with minimum promoter contributions as per SEBI ICDR Regulations.

2. In addition to the above, our Company has made delayed payments with respect to our borrowings for certain periods including up to Fiscal 2019.

### **Launch of key products or services, entry in new geographies or exit from existing markets, capacity/ facility creation or location of plants**

For details of launch of key products or services, entry in new geographies or exit from existing markets, capacity/facility creation, location of our manufacturing facilities, see “*Our Business*” on page 111.

#### *Significant strategic or financial partnerships*

Our Company does not have any significant strategic or financial partners.

### **Details regarding material acquisitions or divestments of business/undertakings, mergers, amalgamations or any revaluation of assets, in the last ten years**

Our Company has not undertaken any material acquisitions or divestments of any business or undertaking, and has not undertaken any merger, amalgamation or any revaluation of assets, in the last ten years.

### **Material Subsisting Agreements**

#### **A. Investment Agreement**

**Investment Agreement dated September, 2007 entered into amongst our Company, our Promoters, members of our Promoter Group namely, Ashok Dayashankar Madeka, Paresh Dayashankar Madeka, Mihir Rupeshkumar Madeka, Hemal Paresh Madeka, Sanjay Bhagwanji Bole and Bharat Jiten Madeka and Rivendell PE LLC (formerly NSR-PE Mauritius LLC) (“Investor”) (“Investment Agreement”)**

In terms of the Investment Agreement, our Company agreed to allot Investor 2,850 CCPS for an aggregate consideration of ₹ 1,510,072,500. Further, the CCPS were to be automatically converted into fully paid-up Equity Shares no later than July 31, 2010. For details of the conversion, see “*Capital Structure Notes to Capital Structure Share Capital History History of Equity Share Capital of our Company*” on page 64.

The Investment Agreement confers certain rights on Investor including right to nominate two directors to our Board. Further, appointment/any change of the independent directors is subject to approval of Investor. Additionally, in terms of the Investment Agreement, the Investor has the option to further subscribe to new Equity Shares, in the event its shareholding falls or is contemplated to fall below 26.88 per cent of the fully diluted share capital of our Company.

## **B. Shareholders' Agreement**

### **Shareholders' Agreement dated September, 2007 entered into between our Company, our Promoters, certain members of our Promoter Group and Investor ("SHA")**

The SHA was executed on September 2007, by and among our Company, the Investor, our Promoters, and members of the Promoter Group, namely, Ashok Dayashankar Madeka, Paresch Dayashankar Madeka, Mihir Rupeshkumar Madeka, Hemal Paresch Madeka, Sanjay Bhagwanji Bole and Bharat Jiten Madeka (collectively, "**Parties**") to, *inter alia*, record the inter-se rights and obligations of the parties. In terms of the SHA, the number of directors on the Board shall be seven including two nominee directors appointed by the Investor. The SHA also identifies certain matters as reserved, each of which may be ratified at a Board or Shareholders' meeting only if the consent of the Investor has been obtained in writing, as long as the Investor holds five per cent or more of the total number of shares of our Company. These matters, *inter alia*, include (i) any change in the chairman/ managing director of our Company; (ii) appointment or change of the statutory auditors of our Company, (iii) any related party transaction, (iv) appointment or remuneration of the senior management team of our Company, (v) decisions in relation to the initial public offer of the Company, (vi) determination of dividend policy and any alteration thereof and the declaration and distribution of any dividends to the Shareholders; (vi.) any amendments, modification or waiver of any provision of the MoA or Articles of Association; and (vii.) any transfer or issuance of Equity Shares or equity linked securities or convertible bonds of our Company either as a public offering or as a private sale.

Apart from the above, in accordance with the terms of the SHA, *inter alia*, the Investor has (i.) right to access and inspect all information provided to any member of the Board, books of accounts and other business records; (ii.) a right of first refusal in relation to transfers proposed to be effected by our Promoters and members of the Promoter Group or their affiliates; and (iii.) a tag along right to in relation to transfer of shares held by our Promoters or their affiliates.

In order to facilitate the Offer and to take into account certain other developments, the Parties have entered into the amendment agreement dated March 12, 2021 ("**Amendment Agreement**"), to replace and amend certain terms of the Shareholders' Agreement. In accordance with the provisions of the Amendment Agreement, the SHA shall be terminated with effect from the date of listing of the Equity Shares and accordingly all the rights available to the Shareholders, except as mentioned below, shall cease to exist upon listing of the Equity Shares.

In terms of the Articles of Association, the Investor, post the completion of the Offer, shall have the right to nominate a director to our Board till the time the Investor holds directly or indirectly an aggregate interest (including any beneficial interest) in the shares which is equivalent to, or referenced to, 5% (five per cent) or more of the issued share capital of the Company. This right and right to appoint an observer will be subject to approval of the Shareholders by way of a special resolution in a general meeting post listing of the Equity Shares. For further details, see section "Main Provisions of Articles of Association" on page 299.

## **C. Other subsisting material agreements other than in the ordinary course of business carried of our Company**

Except as disclosed on page 133 of "*History and Certain Corporate Matters - Defaults or rescheduling/restructuring of borrowings*", we are not currently party to any subsisting material contract other than in the ordinary course of business carried on by our Company.

### **Holding company, subsidiary or joint venture**

As on the date of this Prospectus, our Company does not have any holding company, subsidiary, or joint venture.

### **Agreements with Key Managerial Personnel, Director, Promoter or any other employee**

There are no agreements entered into by a Key Managerial Personnel or Director or Promoter or any other employee of our Company, either by themselves or on behalf of any other person, with any Shareholder or any other third party with regard to compensation or profit sharing in connection with dealings in the securities of our Company.

## OUR MANAGEMENT

### Our Board

Our Company currently has eight Directors on its Board, including four independent directors, out of which one is a woman director. For details on the strength of our Board, as permitted and required under the Articles of Association, see “Main Provisions of Articles of Association” on page 299.

The following table sets forth details regarding our Board as of the date of this Prospectus:

Name, Designation, Address, Occupation, Period of Directorship, Term, Date of Birth and DIN	Age (years)	Other Directorships
<p><b>Manesh Dayashankar Madeka</b></p> <p><i>Designation:</i> Chairman and Managing Director</p> <p><i>Address:</i> Maya, Parnakuti Society Street Number 5, Plot number 61, Nana Mava Road, Rajkot, Gujarat, 360 001</p> <p><i>Occupation:</i> Business</p> <p><i>Period and Term of Directorship:</i> Appointed as a director with effect from March 12, 2021 for a period 5 years</p> <p><i>Date of Birth:</i> May 27, 1958</p> <p><i>DIN:</i> 01629788</p>	63	Nil
<p><b>Bhautik Dayashankar Madeka</b></p> <p><i>Designation:</i> Whole Time Director</p> <p><i>Address:</i> 27, Trisha Bunglow, Near Chandan Super Market, Amin Marg, Rajkot, Gujarat, 360001</p> <p><i>Occupation:</i> Business</p> <p><i>Period and Term of Directorship:</i> Appointed as a director with effect from March 12, 2021 for a period 5 years</p> <p><i>Date of Birth:</i> January 1, 1965</p> <p><i>DIN:</i> 01761543</p>	56	Nil
<p><b>Mihir Rupeshkumar Madeka</b></p> <p><i>Designation:</i> Whole Time Director</p> <p><i>Address:</i> Daya Parnakuti Society, Street No. 3, Plot No. 11, Nana Mava Road, Rajkot, Gujarat, 360001</p> <p><i>Occupation:</i> Business</p> <p><i>Period and Term of Directorship:</i> Appointed as a director with effect from March 12, 2021 for a period 5 years</p> <p><i>Date of Birth:</i> July 19, 1977</p> <p><i>DIN:</i> 01778561</p>	44	Nil

Name, Designation, Address, Occupation, Period of Directorship, Term, Date of Birth and DIN	Age (years)	Other Directorships
<p><b>Vivek Sett</b></p> <p><i>Designation:</i> Nominee Director</p> <p><i>Address:</i> 1001 Marathon Heights, P. B. Marg, Worli, Delisle Road, Mumbai, Maharashtra, 400 013</p> <p><i>Occupation:</i> Business</p> <p><i>Period and Term of Directorship:</i> Appointed with effect from September 22, 2007</p> <p><i>Date of Birth:</i> January 9, 1955</p> <p><i>DIN:</i> 00031084</p>	66	<ol style="list-style-type: none"> <li>1. Nectar Life Sciences Limited</li> <li>2. GMS Edible Oils Private Limited</li> <li>3. Vasudev Adigas Fastfood Private Limited</li> <li>4. Destimoney India Services Private Limited</li> <li>5. Ascend Telecom Infrastructure Private Limited</li> <li>6. New Silk Route Advisors Private Limited</li> <li>7. Destimoney Financial Services Private Limited</li> <li>8. Demello Telepower Private Limited</li> </ol>
<p><b>Pravinchandra Ratilal Dholakia</b></p> <p><i>Designation:</i> Independent Director</p> <p><i>Address:</i> Pooja Adarsh Society 3/5, Race Course Ring Road, Behind I.O.C Bhavan, Rajkot, Gujarat 360001</p> <p><i>Occupation:</i> Business</p> <p><i>Period and Term of Directorship:</i> Appointed as a director with effect from March 12, 2021 for a period 5 years</p> <p><i>Date of Birth:</i> July 16, 1945</p> <p><i>DIN:</i> 00844014</p>	76	Nil
<p><b>Dipesh Dhirajlal Kundaliya</b></p> <p><i>Designation:</i> Independent Director</p> <p><i>Address:</i> Amijyot, 9/14 Sardar Nagar, Sardar Nagar Main Road, Near Jain Upasara, Rajkot, Gujarat 360001</p> <p><i>Occupation:</i> Service</p> <p><i>Period and Term of Directorship:</i> Appointed as a director with effect from March 12, 2021 for a period 5 years</p> <p><i>Date of Birth:</i> July 26, 1978</p> <p><i>DIN:</i> 08035547</p>	43	Nil
<p><b>Jignasa Pravinchandra Mehta</b></p> <p><i>Designation:</i> Independent Director</p> <p><i>Address:</i> M-193, Gujarat Housing Board, behind Jankalyan Community Hall, Amin Marg, Rajkot, Gujarat 360001</p> <p><i>Occupation:</i> Business</p>	47	Nil

Name, Designation, Address, Occupation, Period of Directorship, Term, Date of Birth and DIN	Age (years)	Other Directorships
<p><i>Period and Term of Directorship:</i> Appointed as a director with effect from March 12, 2021 for a period 5 years</p> <p><i>Date of Birth:</i> November 29, 1973</p> <p><i>DIN:</i> 08035567</p>		
<p><b>Ashit Ravishankar Vankani</b></p> <p><i>Designation:</i> Independent Director</p> <p><i>Address:</i> Suraj Apartment-02, Flat No – 51/A, Shroff Road, Rajkot, Gujarat 360001</p> <p><i>Occupation:</i> Business</p> <p><i>Period and Term of Directorship:</i> Appointed as a director with effect from March 12, 2021 for a period 5 years</p> <p><i>Date of Birth:</i> April 3, 1957</p> <p><i>DIN:</i> 08988523</p>	64	Nil

#### Brief profiles of our Directors

**Manesh Dayashankar Madeka** is our Chairman and Managing Director. He together with Rupesh Dayashankar Madeka started the business under the partnership firm by the name of Rolex Industries in 1978. He has over 40 years of work experience in marketing, production and finance.

**Bhautik Dayashankar Madeka** is our Whole Time Director. He holds a bachelor's degree in commerce from Ranchi University, Ranchi. He has over 18 years of work experience in production, planning and control. He joined our Company on December 31, 2002 when it was still a partnership firm.

**Mihir Rupeshkumar Madeka** is our Whole Time Director. He holds a bachelor's degree in engineering from Nagpur University. He has over 18 years of work experience in marketing functions and in the development of new customers and products. He joined our Company on December 31, 2002 when it was still a partnership firm.

**Vivek Sett** is our Nominee Director. He has been admitted as an associate of The Institute of Chartered Accountants of India. He was previously associated with Ispat Industries as its director (commercial) and Tata Realty & Infrastructure, Tata Teleservices Limited and Hughes Telecom (India) Limited as their chief financial officer. He is currently a Partner at New Silk Route Advisors.

**Pravinchandra Ratilal Dholakia** is our Independent Director. He is a fellow of the Institute of Chartered Accountants of India. He has been qualified as a practicing chartered accountant since 1974. He is currently a senior partner at P.R Dholakia & Co., Chartered Accountants.

**Dipesh Dhirajlal Kundaliya** is our Independent Director. He holds a master's degree in engineering (mechanical) from Saurashtra University and a doctor of philosophy in engineering from Shri Jagdishprasad Jhabarmal Tibrewala University, Jhunjhunu. He is a qualified Certified Energy Manager and a Certified Energy Auditor of the National Productivity Council. He is a member of The Institution of Engineers (India) and has been awarded use of the title Chartered Engineer (India) for the mechanical engineering division. He is also a member of the Indian Society for Technical Education and a fellow of the Institution of Valuers, India.

**Jignasa Pravinchandra Mehta** is our Independent Director. She holds a bachelor's degree in engineering (mechanical), a master's degree in engineering (machine design) and a doctorate of philosophy in mechanical engineering from Sardar Patel University, Gujarat. She has completed a short-term training program on MATLAB Fundamentals and Applications for Mechanical Engineers by V.V.P. Engineering College Rajkot. She is a professor and the head of the department of mechanical engineering at V.V.P Engineering College, Rajkot.

**Ashit Ravishankar Vankani** is our Independent Director. He holds a diploma in electrical engineering and mechanical engineering from the Government Polytechnic, Rajkot. He is currently associated with National Wire Products in the capacity of a partner since 1975.

#### **Family relationship between Directors**

Manesh Dayashankar Madeka and Bhautik Dayashankar Madeka are brothers. Mihir Rupeshkumar Madeka is the nephew of Manesh Dayashankar Madeka and Bhautik Dayashankar Madeka.

#### **Arrangements and understanding with major shareholders, customers, suppliers or others**

Except for Vivek Sett who was appointed as the nominee director for Rivendell PE LLC, none of our Directors have been appointed/ selected as a director or a member of senior management pursuant to any arrangement or understanding with our major shareholders, customers, suppliers or others.

#### **Term of Appointment of our Directors**

##### **1. Remuneration details of our executive Directors**

##### **Manesh Dayashankar Madeka**

Pursuant to a resolution of our Board dated March 12, 2021, Manesh Dayashankar Madeka is entitled to the following remuneration:

<b>Particulars</b>	<b>Remuneration</b>
Tenure	5 years
Basic pay	₹ 8,00,000/- per month as basic;-
Bonus	As may be determined by the Nomination and Remuneration Committee or Board of Directors of the Company
Gratuity	As per the rules of the Company, subject to completion of service of 5 years at the rate of half a month's salary for each year of completed service with effect from March 12, 2021;
Provident fund	Company's contribution to provident fund, to the extent that it is not taxable under the Income Tax Act, 1961
Benefits, perquisites, allowances	Provision of a Car with driver for official purposes and such driver's remuneration/expenses as fixed/approved by the Board shall be reimbursed to him, if he is not provided with Company's driver.
	Free use of Company's mobile phone and telephone at his residence
	Reimbursement of medical expenses incurred by him and his family, subject to a ceiling of one month's salary in a year, or three months' salary over a period of 3 years;
	Actual leave travel expenses, as per the rules of the Company, excluding hotel and food charges, once in a year to any place in India to himself and his family.

During Fiscal 2021, our Company paid Manesh Dayashankar Madeka a remuneration of ₹ 9.60 million\*.

*\*The remuneration does not include gratuity, since the same is calculated for all the employees of the Company as a whole.*

##### **Bhautik Dayashankar Madeka**

Pursuant to a resolution of the board dated March 12, 2021, Bhautik Dayashankar Madeka is entitled to the following remuneration:

<b>Particulars</b>	<b>Remuneration</b>
Tenure	5 years
Basic pay	₹ 7,80,000/- per month as basic;
Bonus	As may be determined by the Nomination and Remuneration Committee or Board of Directors of the Company
Gratuity	As per the rules of the Company, subject to completion of service of 5 years at the rate of half a month's salary for each year of completed service with effect from March 12, 2021;
Provident fund	Company's contribution to provident fund, to the extent that it is not taxable under the Income Tax Act, 1961
Benefits, perquisites, allowances	Provision of a Car with driver for official purposes and such driver's remuneration/expenses as fixed/approved by the Board shall be reimbursed to him, if he is not provided with Company's driver. Free use of Company's mobile phone and telephone at his residence Reimbursement of medical expenses incurred by him and his family, subject to a ceiling of one month's salary in a year, or three months' salary over a period of 3 years; Actual leave travel expenses, as per the rules of the Company, excluding hotel and food charges, once in a year to any place in India to himself and his family.

During Fiscal 2021, our Company paid Bhautik Dayashankar Madeka a remuneration of ₹ 9.36 million\*.

\*The remuneration does not include gratuity, since the same is calculated for all the employees of the Company as a whole.

#### **Mihir Rupeshkumar Madeka**

Pursuant to a resolution of the board dated March 12, 2021, Mihir Rupeshkumar Madeka is entitled to the following remuneration:

<b>Particulars</b>	<b>Remuneration</b>
Tenure	5 years
Basic pay	₹ 7,00,000/- per month as basic;
Bonus	As may be determined by the Nomination and Remuneration Committee or Board of Directors of the Company
Gratuity	As per the rules of the Company, subject to completion of service of 5 years at the rate of half a month's salary for each year of completed service with effect from March 12, 2021;
Provident fund	Company's contribution to provident fund, to the extent that it is not taxable under the Income Tax Act, 1961
Benefits, perquisites, allowances	Provision of a Car with driver for official purposes and such driver's remuneration/expenses as fixed/approved by the Board shall be reimbursed to him, if he is not provided with Company's driver. Free use of Company's mobile phone and telephone at his residence Reimbursement of medical expenses incurred by him and his family, subject to a ceiling of one month's salary in a year, or three months' salary over a period of 3 years; Actual leave travel expenses, as per the rules of the Company, excluding hotel and food charges, once in a year to any place in India to himself and his family.

During Fiscal 2021, our Company paid Mihir Rupeshkumar Madeka a remuneration of ₹ 8.40 million\*.

\*The remuneration does not include gratuity, since the same is calculated for all the employees of the Company as a whole.

## 2. **Remuneration details of our Non-Executive and Independent Directors**

### **Non-Executive Non- Independent Directors**

Our Nominee Director is not entitled to receive any sitting fees.

### **Independent Directors**

Pursuant to the resolution of our Board dated March 12, 2021, our Independent Directors are entitled to receive a sitting fees of ₹ 5,000 for attending each meeting of our Board or its committee thereof.

Details of the sitting fees paid to our Independent Directors, during Fiscal 2021 are set forth below:

<b>Name of Director</b>	<b>Sitting fees paid (In ₹ million)</b>
Pravinchandra Ratilal Dholakia	Nil
Dipesh Dhirajlal Kundaliya	Nil
Jignasa Pravinchandra Mehta	Nil
Ashit Ravishankar Vankani	Nil

### **Bonus or profit sharing plan for the Directors**

Except for Manesh Dayashankar Madeka, Bhautik Dayashankar Madeka and Mihir Rupeshkumar Madeka who are entitled to a bonus as part of the terms of remuneration payable to them, our Company does not have any other bonus or profit-sharing plan for our Directors.

### **Shareholding of our Directors**

Our Articles do not require the Directors to hold any qualification shares.

Except for Manesh Dayashankar Madeka, Bhautik Dayashankar Madeka and Mihir Rupeshkumar Madeka, none of our directors hold any Equity Shares and NCRPS as on the date of this Prospectus.

### **Service contracts with Directors**

There are no service contracts entered into with any of our Directors which provide for any benefit upon termination of employment.

### **Interest of our Directors**

Our Independent Directors are interested to the extent of sitting fees payable to them for attending meetings of the Board or a committee thereof and reimbursement of expenses, if any, payable to them and our executive directors are interested to the extent of remuneration, bonus and reimbursement of expenses, if any, payable to them.

Our Directors may be interested to the extent that they hold Equity Shares and NCRPS in the Company, For further details, see “*Capital Structure*” beginning on page 64.

Our Directors may also be deemed to be interested in Equity Shares that may, pursuant to this Offer, be held by them or held by the entities with which they are associated as partners, or that may be subscribed by or allotted to their relatives, or to the companies, firms, trusts, in which they are interested as directors, members, partners, trustees, proprietors and promoters and to the extent of any dividend payable to them and other distributions in respect of these Equity Shares.

### **Interest in promotion or formation of our Company**

Except for Manesh Dayashankar Madeka and Bhautik Dayashankar Madeka, who are our promoters, none of our Directors have an interest in the promotion or formation of our Company.



### ***Interest in property***

Our Directors have no interest in any property acquired or proposed to be acquired by or of our Company.

### ***Business interest***

Except as stated in “*Our Management - Interest of our Directors*” and “*Related Party Transactions*” on page 141 and on page 159, our Directors do not have any other interest in our business or our Company.

Except as stated in “*Related Party Transactions*” beginning on page 159 and as disclosed in this section, our Directors do not have any other interest in our Company or in any transaction by our Company.

### **Confirmations**

None of our Directors have been identified as Wilful Defaulters.

Our Directors are not, and have not, during the five years preceding the date of this Prospectus, been on the board of any listed company whose shares have been or were suspended from being traded on the BSE or NSE during their term of directorship in such company.

None of our Directors have been or are directors on the board of listed companies which have been or were delisted from any stock exchange(s) during their term of directorship in such company.

No consideration, either in cash or shares or in any other form have been paid or agreed to be paid to any of our Directors or to the firms, trusts or companies in which they have an interest in, by any person, either to induce him to become or to help him qualify as a Director, or otherwise for services rendered by him or by the firm, trust or company in which he is interested, in connection with the promotion or formation of our Company.

### **Changes in our Board during the last three years**

The changes in our Board during the three years immediately preceding the date of this Prospectus are as follows:

<b>Name of Director</b>	<b>Date of change</b>	<b>Reasons</b>
Manesh Dayashankar Madeka	March 12, 2021	Re-appointed as Chairman and Managing Director
Bhautik Dayashankar Madeka	March 12, 2021	Re-appointed as Whole Time Director
Mihir Rupeshkumar Madeka	March 12, 2021	Re-appointed as Whole Time Director
Pravinchandra Ratilal Dholakia	March 12, 2021	Appointment as Independent Director
Dipesh Dhirajlal Kundaliya	March 12, 2021	Appointment as Independent Director
Jignasa Pravinchandra Mehta	March 12, 2021	Appointment as Independent Director
Ashit Ravishankar Vankani	March 12, 2021	Appointment as Independent Director

### **Borrowing Powers**

Subject to the provisions of the Companies Act, our Articles of Association authorise our Board, at its discretion, to generally secure the payment of any sum or sums of money for the purposes of our Company. Pursuant to a resolution passed by the Board on March 12, 2021 and Shareholders at the annual general meeting held on March 12, 2021, our Board has been authorised to borrow any sum or sums of monies in excess of our Company’s aggregate paid-up capital and free reserves (apart from temporary loans obtained from our Company’s bankers in the ordinary course of business), provided that the total amount which may be so borrowed and outstanding shall not exceed a sum of ₹ 8,500 million at any point of time.

## Corporate Governance

In addition to the Companies Act, 2013, the corporate governance provisions of the SEBI Listing Regulations will also be applicable to our Company immediately upon the listing of the Equity Shares on the Stock Exchanges.

Our Company currently has eight Directors, of which three are executive Directors, and five are non-executive directors. Of the non-executive directors, four are Independent Directors, one of whom is a Woman Director. Our Company is in compliance with corporate governance norms prescribed under the SEBI Listing Regulations and the Companies Act, 2013, particularly, in relation to the composition of our Board of Directors and the constitution of our Board level committees.

Our Company undertakes to continue to comply with the corporate governance norms under the SEBI Listing Regulations, and the Companies Act, 2013.

### *Board-level committees*

In terms of the SEBI Listing Regulations, and the provisions of the Companies Act, 2013, our Company has constituted the following Board-level committees:

- (i) Audit Committee;
- (ii) Nomination and Remuneration Committee;
- (iii) Stakeholders' Relationship Committee;
- (iv) Corporate Social Responsibility Committee.

### *Audit Committee*

The Audit Committee currently consists of:

Name	Position in the committee	Designation
Pravinchandra Ratilal Dholakia	Chairman	Independent Director
Jignasa Pravinchandra Mehta	Member	Independent Director
Dipesh Dhirajlal Kundaliya	Member	Independent Director
Ashit Ravishankar Vankani	Member	Independent Director
Vivek Sett	Member	Nominee Director
Manesh Dayashankar Madeka	Member	Chairman and Managing Director

Our Audit Committee was last re-constituted by a resolution of our Board dated March 12, 2021, in compliance with the Companies Act, 2013 and SEBI Listing Regulations. The terms of reference of the Audit Committee include the following:

### *Powers of the Audit Committee*

1. To investigate any activity within its terms of reference;
2. To seek information from any employee;
3. To obtain outside legal or other professional advice; and;
4. To secure attendance of outsiders with relevant expertise, if it considers necessary

### *Functions of the Audit Committee*

- a. Overseeing the Company's financial reporting process and disclosure of its financial information to ensure that the financial statement is correct, sufficient and credible;
- b. Recommending to the Board, the appointment, re-appointment, and replacement, remuneration, and terms of appointment of the statutory auditor and the fixation of audit fee;

- c. Reviewing and monitoring the auditor's independence and performance and the effectiveness of audit process;
- d. Approving payments to the statutory auditors for any other services rendered by statutory auditors;
- e. Reviewing, the financial statements with respect to its unlisted subsidiaries, in particular investments made by such subsidiaries;
- f. Reviewing with the management, the annual financial statements and auditor's report thereon before submission to the Board for approval, with particular reference to:
  - i. Matters required to be stated in the Director's responsibility statement to be included in the Board's report in terms of section 134(3)(c) of the Companies Act, 2013;
  - ii. Changes, if any, in accounting policies and practices and reasons for the same;
  - iii. Major accounting entries involving estimates based on the exercise of judgment by management;
  - iv. Significant adjustments made in the financial statements arising out of audit findings;
  - v. Compliance with listing and other legal requirements relating to financial statements;
  - vi. Disclosure of any related party transactions; and
  - vii. Qualifications and modified opinions in the draft audit report.
- g. Reviewing with the management, the quarterly, half-yearly and annual financial statements before submission to the Board for approval;
- h. Scrutiny of inter-corporate loans and investments;
- i. Review of utilization of loans availed or investments by the holding company in the subsidiary exceeding ₹ 100 crore or 10% of the asset size of the subsidiary, whichever is lower;
- j. Valuation of undertakings or assets of the Company, wherever it is necessary;
- k. Evaluation of internal financial controls and risk management systems;
- l. Approval or any subsequent modification of transactions of the Company with related parties;
- m. Reviewing with the management, the statement of uses/application of funds raised through an issue (public issue, rights issue, preferential issue, etc.), the statement of funds utilized for purposes other than those stated in the offer document/prospectus/notice and the report submitted by the monitoring agency monitoring the utilization of proceeds of a public or rights issue, and making appropriate recommendations to the Board to take up steps in this matter;
- n. Approving or subsequently modifying transactions of the Company with related parties;
- o. Evaluating undertakings or assets of the Company, wherever necessary;
- p. Establishing and overseeing a vigil mechanism for directors and employees to report their genuine concerns or grievances;
- q. Reviewing, with the management, the performance of statutory and internal auditors and adequacy of the internal control systems;

- r. Reviewing the adequacy of internal audit function, if any, including the structure of the internal audit department, staffing and seniority of the official heading the department, reporting structure coverage and frequency of internal audit;
- s. Discussion with internal auditors on any significant findings and follow up thereon;
- t. Reviewing the findings of any internal investigations by the internal auditors into matters where there is suspected fraud or irregularity or a failure of internal control systems of a material nature and reporting the matter to the Board;
- u. Discussion with statutory auditors before the audit commences, about the nature and scope of audit as well as post-audit discussion to ascertain any area of concern;
- v. Looking into the reasons for substantial defaults in the payment to the depositors, debenture holders, shareholders (in case of non-payment of declared dividends) and creditors;
- w. Approval of appointment of the chief financial officer after assessing the qualifications, experience and background, etc. of the candidate;
- x. Recommending to the Board of Directors the appointment and removal of the external auditor, fixation of audit fees and approval for payment for any other services;
- y. Reviewing the functioning of the whistle blower mechanism, in case the same is existing;
- z. Carrying out any other functions as provided under the Companies Act, the Listing Regulations and other applicable laws; and
- aa. To formulate, review and make recommendations to the Board to amend the Audit Committee charter from time to time.

Besides the above, the role of the Audit Committee includes mandatory review of the following information:

- a. Management Discussion and Analysis of financial condition and results of operations;
- b. Statement of significant related party transactions (as defined by the audit committee), submitted by Management;
- c. Management letters/letters of internal control weaknesses issued by the statutory auditors, if any;
- d. Internal audit reports relating to internal control weaknesses; and
- e. The appointment, removal and terms of remuneration of the Chief Internal Auditor.
- f. Statement of deviations:
  - i. quarterly statement of deviation(s) including report of monitoring agency, if applicable, submitted to stock exchange(s) in terms of Regulation 32(1) of the Listing Regulations; and
  - ii. annual statement of funds utilized for purposes other than those stated in the offer document/prospectus/notice in terms of Regulation 32(7) of the Listing Regulations.

#### ***Nomination and Remuneration Committee***

The Nomination and Remuneration Committee currently consists of:

<b>Name</b>	<b>Position in the committee</b>	<b>Designation</b>
Dipesh Dhirajlal Kundaliya	Chairman	Independent Director
Ashit Ravishankar Vankani	Member	Independent Director
Jignasa Pravinchandra Mehta	Member	Independent Director

The Nomination and Remuneration Committee was constituted by a resolution of our Board dated March 12, 2021, in compliance with Section 178 of the Companies Act, 2013. The terms of reference of the Nomination and Remuneration Committee include the following:

- a. Formulating the criteria for determining qualifications, positive attributes and independence of a director and recommend to the Board of directors a policy, relating to the remuneration of the directors, key managerial personnel and other employees. The Nomination and Remuneration Committee, while formulating the above policy, should ensure that:
  - i. the level and composition of remuneration be reasonable and sufficient to attract, retain and motivate directors of the quality required to run our Company successfully;
  - ii. relationship of remuneration to performance is clear and meets appropriate performance benchmarks; and
  - iii. remuneration to directors, key managerial personnel and senior management involves a balance between fixed and incentive pay reflecting short and long term performance objectives appropriate to the working of the Company and its goals;
- b. Formulating criteria for evaluation of performance of independent directors and the Board of Directors;
- c. Devising a policy on diversity of Board of Directors;
- d. Identifying persons who are qualified to become directors and who may be appointed in senior management in accordance with the criteria laid down, and recommend to the Board of directors their appointment and removal and shall specify the manner for effective evaluation of performance of the Board, its committees and individual directors to be carried out either by the Board, by the Nomination and Remuneration Committee or by an independent external agency and review its implementation and compliance. The Company shall disclose the remuneration policy and the evaluation criteria in its annual report;
- e. Extending or continuing the term of appointment of the independent director, on the basis of the report of performance evaluation of independent directors;
- f. Recommending to the board, all remuneration, in whatever form, payable to senior management;
- g. Framing suitable policies and systems to ensure that there is no violation, as amended from time to time, of any securities laws or any other applicable laws in India or overseas, including:
  - i. The Securities and Exchange Board of India (Prohibition of Insider Trading) Regulations, 2015, as amended; and
  - ii. The Securities and Exchange Board of India (Prohibition of Fraudulent and Unfair Trade Practices relating to the Securities Market) Regulations, 2003, as amended;
- h. Carrying out any other function as is mandated by the Board from time to time and / or enforced/mandated by any statutory notification, amendment or modification, as may be applicable; and
- i. Performing such other functions as may be necessary or appropriate for the performance of its duties and/or specified/provided under the Companies Act or the SEBI Listing Regulations, or by any other regulatory authority.

### ***Stakeholders' Relationship Committee***

The Stakeholders' Relationship Committee currently comprises:

<b>Name</b>	<b>Position in the committee</b>	<b>Designation</b>
Manesh Dayashankar Madeka	Chairman	Chairman and Managing Director
Mihir Dayashankar Madeka	Member	Whole-Time Director
Dipesh Dayashankar Kundaliya	Member	Independent Director

Our Stakeholders' Relationship Committee was constituted by a resolution of our Board dated March 12, 2021, in compliance with Section 178 of the Companies Act, 2013, and the SEBI Listing Regulation. The terms of reference of the Stakeholders' Relationship Committee include the following:

- a. Considering and looking into various aspects of interest of shareholders, debenture holders and other security holders;
- b. Resolving the grievances of the security holders of the Company including complaints related to transfer/transmission of shares, non-receipt of annual report, non-receipt of declared dividends, issue of new/duplicate certificates, general meetings, etc.;
- c. Review of measures taken for effective exercise of voting rights by shareholders;
- d. Review of adherence to the service standards adopted by the Company in respect of various services being rendered by the Registrar & Share Transfer Agent; and
- e. Review of the various measures and initiatives taken by the Company for reducing the quantum of unclaimed dividends and ensuring timely receipt of dividend warrants/annual reports/statutory notices by the shareholders of the Company.
- f. Performing such other activities as may be delegated by the Board or specified/ provided under the Companies Act, 2013 or by the SEBI Listing Regulations or statutorily prescribed under any other law or by any other regulatory authority.

### ***Corporate Social Responsibility Committee ("CSR Committee")***

The CSR Committee currently comprises of:

<b>Name</b>	<b>Position in the committee</b>	<b>Designation</b>
Manesh Dayashankar Madeka	Chairman	Chairman and Managing Director
Bhautik Dayashankar Madeka	Member	Whole Time Director
Mihir Rupeshkumar Madeka	Member	Whole Time Director
Hiren Dilipbhai Doshi	Member	Chief Financial Officer

The CSR Committee was last re-constituted by a resolution of our Board dated March 12, 2021 in compliance with Section 135 of the Companies Act, 2013. The terms of reference of the CSR Committee include the following:

- a. To formulate and recommend to the board, a Corporate Social Responsibility Policy which shall indicate the activities to be undertaken by the company as specified in Schedule VII of the Companies Act, 2013 and make any revisions therein as and when decided by the Board;
- b. To review and recommend the amount of expenditure to be incurred on the activities referred to in (a);
- c. To monitor the Corporate Social Responsibility Policy of the company and its implementation from time to time;
- d. To do such other acts, deeds and things as may be required to comply with the applicable laws and to perform such other activities as may be delegated by the Board or specified/ provided under the Companies Act, 2013 or by the SEBI Listing Regulations or statutorily prescribed under any other law or by any other regulatory authority.

## Management Organisation Structure

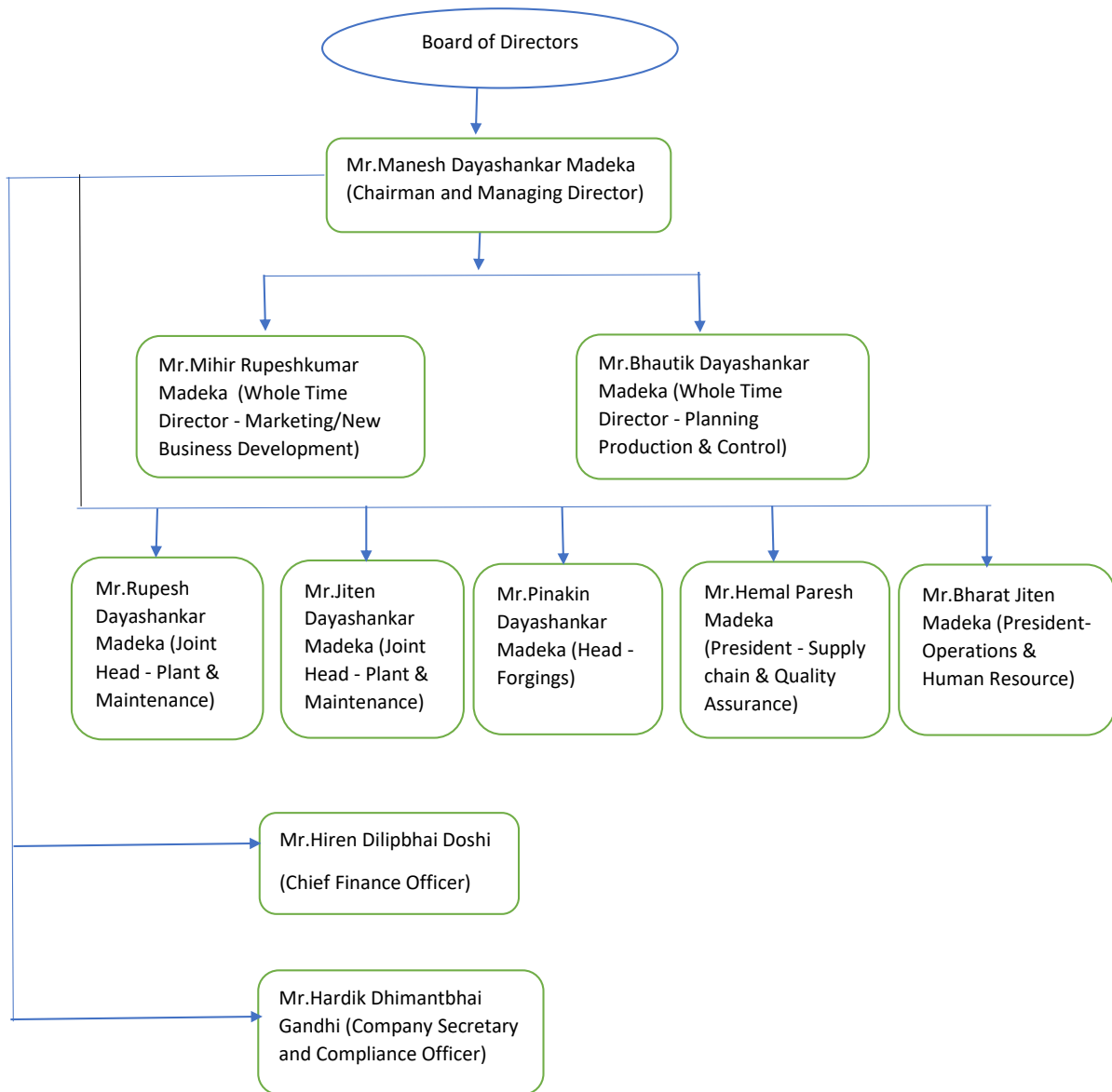

## Key Management Personnel

In addition to Manesh Dayashankar Madeka, our Managing Director and Chairman, Bhautik Dayashankar Madeka and Mihir Rupeshkumar Madeka, our Whole Time Directors, whose details are provided in “*Brief profiles of our Directors*” on page 138, the details of our other Key Management Personnel as defined in Section 2(51) of the Companies Act, 2013, as on the date of this Prospectus, are as set forth below.

### Brief profiles of our Key Management Personnel

**Bharat Jiten Madeka** is the President - Operations & Human Resources of our Company. He has a diploma in engineering (mechanical) from N.M. Gopani Polytechnic Institute, Ranpur. He joined our Company in the year 2007 and has had over 13 years of experience in tool designing and forging lines. Our Company paid him a remuneration of ₹ 8.40 million\* in Fiscal 2021\*.

*\*The remuneration does not include gratuity, since the same is calculated for all the employees of the Company as a whole.*

**Hemal Paresh Madeka** is the President – Supply chain & Quality Assurance of our Company. He holds a bachelor’s degree in engineering (mechanical) from Nagpur University. He joined our Company while it was still a partnership firm on December 31, 2002 and has over 18 years of experience with our Company. He is responsible for the supply chain and quality assurance function of our Company. Our Company paid him a remuneration of ₹ 6.60 million\* in Fiscal 2021\*.

*\*The remuneration does not include gratuity, since the same is calculated for all the employees of the Company as a whole.*

**Hiren Dilipbhai Doshi** is the Chief Financial Officer of our Company. He joined our Company as Vice President – Finance with effect from February 1, 2009 and was designated as the Chief Financial Officer with effect from March 12, 2021. He is a certified chartered accountant of the Institute of Chartered Accountants of India. He has been responsible for the finance function of our Company. Prior to joining our Company, he worked with Atul Auto Limited for over 11 years. Our Company paid him a remuneration of ₹ 3.49 million\* in Fiscal 2021\*.

*\*The remuneration does not include gratuity, since the same is calculated for all the employees of the Company as a whole.*

**Jiten Dayanshankar Madeka** is the Joint head of Plant & Maintenance of our Company. He joined our Company while it was still a partnership firm in 1978. He has over 42 years of work experience with our Company in tool development and optimum utilisation for of operational equipment efficiency. Our Company paid him a remuneration of ₹ 7.20 million\* in Fiscal 2021\*.

*\*The remuneration does not include gratuity, since the same is calculated for all the employees of the Company as a whole.*

**Pinakin Dayashankar Madeka** is the Head of Forgings of our Company. He joined our Company while it was still a partnership firm in 1989. He has over 31 years of work experience with our Company. He is responsible for the forging functions of our Company. Our Company paid him a remuneration of ₹ 7.20 million\* in Fiscal 2021\*.

*\*The remuneration does not include gratuity, since the same is calculated for all the employees of the Company as a whole.*

**Rupesh Dayashankar Madeka** is the Joint head of Plant & Maintenance of our Company. He together with Manesh Dayashankar Madeka started the business under the partnership firm by the name of Rolex Industries in 1978 and has over 42 years of work experience. He is responsible for the plant and maintenance function of our Company. Our Company paid him a remuneration of ₹ 7.20 million\* in Fiscal 2021\*.

*\*The remuneration does not include gratuity, since the same is calculated for all the employees of the Company as a whole.*

**Hardik Dhimantbhai Gandhi** is our Company Secretary and Compliance Officer. He joined our Company as Company Secretary with effect from June 12, 2015 and was designated as a compliance officer with effect from March 12, 2021. He is an associate member of the Institute of the Company Secretaries of India. Prior to joining our Company, he was associated with MJP Associates as a trainee. He has over 5 years of experience in legal and secretarial compliance. He is responsible for the secretarial and compliance functions of our Company. Our Company paid him a remuneration of ₹ 0.17 million\* in Fiscal 2021\*.

*\*The remuneration does not include gratuity, since the same is calculated for all the employees of the Company as a whole.*



## Relationship between Key Management Personnel and Directors

Manesh Dayashankar Madeka, Bhautik Dayashankar Madeka, Jiten Dayanshankar Madeka, Pinakin Dayashankar Madeka and Rupesh Dayashankar Madeka are brothers and Hemal Paresh Madeka is their nephew. Mihir Rupeshkumar Madeka is the son of Rupesh Dayashankar Madeka and is the nephew of Manesh Dayashankar Madeka, Bhautik Dayashankar Madeka, Jiten Dayanshankar Madeka and Pinakin Dayashankar Madeka. Bharat Jiten Madeka is the son of Jiten Dayanshankar Madeka and is nephew of Manesh Dayashankar Madeka, Bhautik Dayashankar Madeka Pinakin Dayashankar Madeka and Rupesh Dayashankar Madeka

## Bonus or profit-sharing plan for the Key Management Personnel

Except as provided for the Directors above, none of our Key Management Personnel are party to any bonus or profit-sharing plan of our Company, other than performance-linked bonus, as may be decided by the Nomination and Remuneration Committee.

## Status of Key Managerial Personnel

All the Key Managerial Personnel are permanent employees of our Company.

## Shareholding of Key Management Personnel

Other than as provided under “*Capital Structure – Share holding of our Directors and Key Managerial Personnel*”, none of our Key Management Personnel hold any Equity Shares or NCRPS as on the date of this Prospectus.

## Service Contracts with Key Management Personnel

None of our Key Management Personnel have entered into any service contracts with our Company, pursuant to which they are entitled to benefits upon termination of employment.

## Interest of Key Management Personnel

Our Key Managerial Personnel may be interested to the extent that they hold Equity Shares and NCRPS in the Company. Please see “*Capital Structure*” on page 64.

None of our Key Management Personnel have any interest in our Company except to the extent of remuneration received from our Company and as disclosed in this section.

The attrition of our Key Management Personnel is not high compared to the industry in which we operate.

## Arrangements and understanding with major shareholders, customers, suppliers or others

None of our Key Management Personnel have been appointed or selected as a Key Managerial Personnel pursuant to any arrangement or understanding with our major shareholders, customers, suppliers or others.

## Contingent and deferred compensation payable to Directors and Key Management Personnel

There is no contingent or deferred compensation payable to our Directors or Key Management Personnel, which does not form a part of their remuneration.

## Changes in Key Management Personnel during the last three years

Changes in our Key Management Personnel during the three years immediately preceding the date of this Prospectus are set forth below.

Name	Date of change	Reasons for Change
Bharat Jiten Madeka	March 12, 2021	Designated as Key Managerial Personnel
Hemal Paresh Madeka	March 12, 2021	Designated as Key Managerial Personnel
Hiren Dilipbhai Doshi	March 12, 2021	Designated as Chief Financial Officer
Jiten Dayanshankar Madeka	March 12, 2021	Designated as Key Managerial Personnel

<b>Name</b>	<b>Date of change</b>	<b>Reasons for Change</b>
Pinakin Dayashankar Madeka	March 12, 2021	Designated as Key Managerial Personnel
Rupesh Dayashankar Madeka	March 12, 2021	Designated as Key Managerial Personnel
Hardik Dhimantbhai Gandhi	March 12, 2021	Designated as Compliance Officer

### **Employees' Stock Option Plan**

As on the date of this Prospectus, our Company does not have any active employee stock option plan.

### **Payment or Benefit to Key Managerial Personnel**

Except as stated in this section, no non-salary amount or benefit has been paid or given to any of our Company's officers, including our Key Managerial Personnel or Directors, within the two preceding years, or is intended to be paid or given.

## OUR PROMOTER AND PROMOTER GROUP

### Our Promoters

The Promoters of our Company are Rupesh Dayashankar Madeka, Jiten Dayashankar Madeka, Manesh Dayashankar Madeka, Pinakin Dayashankar Madeka, and Bhautik Dayashankar Madeka. As on the date of this Prospectus, our Promoters hold an aggregate of 12,987,407 Equity Shares and 10,711,856 NCRPS, comprising 48.80% of the pre-Offer issued, subscribed and paid-up Equity Share capital, and 78.73% of the issued, subscribed and paid-up NCRPS, respectively, of our Company.

For details of the build-up of our Promoters' shareholding in our Company, see "Capital Structure" on page 64.

The details of our Promoters are as follows:

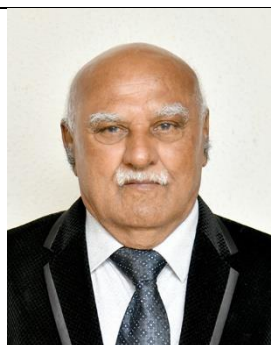

Rupesh Dayashankar Madeka, born on February 23, 1946, aged 75 years, is a citizen of India. He resides at Daya Paran Kutir Society, Street No 3, Block Number 11, Nana Mava Road, Rajkot, Gujarat. His driving license number is GJ03 19990000554. His PAN is AASPM8189J and his aadhar card number is 231537722324. He is a director in Rolex Industries Private Limited, Rolex Properties Private Limited and Madeka Properties Private Limited. For further details, see "Our Management" on page 136.



Jiten Dayashankar Madeka, born on June 1, 1950, aged 71 years, is a citizen of India. He resides at Vasant Street No 5BL No-69/A, Parnkutir Society Nana Mava Road Rajkot, Gujarat. His driving license number is GJ03 19950117511. His PAN is AASPM8192P and his Aadhar card number is 9826 1539 6167. For further details, see "Our Management" on page 136.



Manesh Dayashanker Madeka, born on May 27, 1958, aged 63 years, is a citizen of India. He resides at Maya, Parnakuti Society Street Number 5, Plot number 61, Nana Mava Road, Rajkot, Gujarat. His driving license number is GJ03 00141392021. His PAN is AASPM8191Q and his aadhar card number is 533894601273. For further details, see "Our Management" on page 136.



Pinakin Dayashankar Madeka, born on June 21, 1962, aged 59 years, is a citizen of India. He resides at Maya Parnakuti Society, Street No 5, Nana Mava Road, Rajkot, Gujarat. His driving license number is GJ03 19960113588. His PAN is AASPM8190R and his aadhar card number is 975196605966. He is a director in Rolex Industries Private Limited, Rolex Properties Private Limited and Madeka Properties Private Limited. For further details, see “Our Management” on page 136.



Bhautik Dayashankar Madeka, born on January 1, 1965, aged 56 years, is a citizen of India. He resides at 27, Trisha Bungalow, Chandan Super Market, Amin Marg, Rajkot, Gujarat. His driving license number is GJ03 19970094902. His PAN is ABIPM7370C and his aadhar card number is 388245408656. For further details, see “Our Management” on page 136.

Our Company confirms that the PAN, bank account number and passport number of the promoters, has been submitted to the Stock Exchanges at the time of filing of the Draft Red Herring Prospectus.

#### ***Other ventures of our Promoters***

Except as disclosed in “Our Promoter Group” and “Our Management” on pages 154 and 136, our Promoters are not involved with any other venture.

#### ***Experience of our Promoters in the business of our Company***

For details in relation to experience of our Promoters in the business of our Company, see “Our Management” beginning on page 136.

#### ***Changes in management and control of our Company***

There has been no change in control of our Company in the five years immediately preceding the date of this Prospectus.

#### ***Interests of Promoters and Related Party Transactions***

Our Promoters are interested in our Company to the extent (i) that they have promoted our Company, (ii) their directorship in our Company, if any, (iii) to the extent of their shareholding and the shareholding of their relatives, (iv) the dividend payable thereon and corporate benefits which may be made by our Company, (v) other distributions in respect of the Equity Shares held by them and (vi) to the extent of appointment of their relatives in the place of our profit in our Company. Our Promoters are also interested in our Company to the extent of being the Key Management Personnel of our Company and the remuneration and reimbursement of expenses payable to them in such capacities. For details on shareholding of our Promoters in our Company, see “Capital Structure” on page 64. For further details of interest of our Promoters in our Company, see “Related Party transactions” beginning on page 159.

Our Company has not entered into any contract, agreements or arrangements during the two years immediately preceding the date of this Prospectus and does not propose to enter into any such contract in which our Promoters are directly or indirectly interested and no payment has been made to them in respect of the contracts, agreements or arrangements which are proposed to be made with.

Our Promoters are not interested in any property acquired by our Company in the preceding three years from the date of filing this Prospectus with SEBI, or proposed to be acquired by our Company as on the date of this Prospectus or in any transaction by our Company for acquisition of land, construction of building or supply of machinery.

Our Promoters are not interested as a member of a firm or company, and no sum has been paid, or agreed to be paid to them or to such firm or company, in cash or shares or otherwise by any person either to induce him to become, or to qualify him as a director or otherwise, for services rendered by them or by such firm or company, in connection with the promotion or formation of our Company.

***Payment or Benefits to Promoter or Promoter Group***

Except as stated above, and otherwise as disclosed in the section “*Related Party Transactions*” on page 159 and “*Our Management*” on page 136, there has been no payment or benefit given or paid to our Promoter or Promoter Group during the two years prior to the filing of this Prospectus nor there is any intention to pay or give any benefit to our Promoter or Promoter Group as on the date of this Prospectus.

***Companies with which our Promoters have disassociated in the last three years***

Our Promoters have not disassociated themselves from any company during the last three years preceding the date of this Prospectus.

***Material guarantees given by our Promoters***

Except the Equity Shares and NCRPS held by our Promoters which are subject to pledge in accordance with the provisions of the CDR Package (except such number of Equity Shares which are required for the purpose of minimum promoter contribution in accordance with SEBI ICDR Regulations), there are no material guarantees given by our Promoters to third parties, with respect to the Equity Shares or Preference Shares of our Company.

**Other confirmations**

None of our Promoters have been declared as a fugitive economic offender under the provisions of section 12 of the Fugitive Economic Offenders Act, 2018.

Our Promoters and members of our Promoter Group have not been declared as Wilful Defaulters.

Our Promoters and members of our Promoter Group have not been debarred from accessing the capital market for any reasons by SEBI or any other authorities.

Our Promoters are not promoter or director of any other Company which is debarred from accessing capital markets.

**Our Promoter Group**

**A. Natural persons who are part of the Promoter Group**

The natural persons who are part of the Promoter Group (due to their relationship with our Promoters), other than our Promoters, are as follows:

<b>Name of the Promoter*</b>	<b>Name of the relative</b>	<b>Relationship</b>
<b>Rupesh Dayashankar Madeka</b>	Bharti Rupeshkumar Madeka	Spouse
	Ashok Dayashankar Madeka	Brother
	Paresh Dayashankar Madeka	Brother
	Dharmistha Bole	Sister
	Dina Chanchani	Sister
	Kashmira Navinchandra Bhatt	Sister
	Anila Vora	Sister

<b>Name of the Promoter*</b>	<b>Name of the relative</b>	<b>Relationship</b>
	Mihir Rupeshkumar Madeka	Son
<b>Jiten Dayashankar Madeka</b>	Veena Jitenkumar Madeka	Spouse
	Bharat Jiten Madeka	Son
	Pragati Jiten Madeka	Daughter
	Sanjay Nakani	Brother of the spouse
	Atul Nakani	Brother of the spouse
	Kalindi Mahendra Samrani	Sister of the spouse
	Minuben Prashantbhai Patel	Sister of the spouse
	Kirtiben Bhaveshbhai Mehta	Sister of the spouse
	Ashok Dayashankar Madeka	Brother
	Paresh Dayashankar Madeka	Brother
	Dharmistha Bole	Sister
	Dina Chanchani	Sister
	Kashmira Navinchandra Bhatt	Sister
	Anila Vora	Sister
<b>Manesh Dayashankar Madeka</b>	Rekhaben Madeka	Spouse
	Ami Jagani	Daughter
	Harshi Manesh Madeka	Daughter
	Ashok Dayashankar Madeka	Brother
	Paresh Dayashankar Madeka	Brother
	Dharmistha Bole	Sister
	Dina Chanchani	Sister
	Kashmira Navinchandra Bhatt	Sister
	Anila Vora	Sister
<b>Pinakin Dayashankar Madeka</b>	Namitaben Pinakin Madeka	Spouse
	Kartik Pinakinbhai Madeka	Son
	Dharti Pinakin Madeka	Daughter
	Riddhi Pinakin Madeka	Daughter
	Dinmani Kishanlal Chanchani	Mother of the spouse
	Rajesh K Chanchani	Brother of the spouse
	Ashok Dayashankar Madeka	Brother
	Paresh Dayashankar Madeka	Brother
	Dharmistha Bole	Sister
	Dina Chanchani	Sister
	Kashmira Navinchandra Bhatt	Sister
	Anila Vora	Sister
<b>Bhautik Dayashankar Madeka</b>	Vidhan B Madeka	Son
	Vidhatri Bhoutik Madeka	Daughter
	Shital Vinay Kajaria	Sister of the spouse
	Ashok Dayashankar Madeka	Brother
	Paresh Dayashankar Madeka	Brother

<b>Name of the Promoter*</b>	<b>Name of the relative</b>	<b>Relationship</b>
	Dharmistha Bole	Sister
	Dina Chanchani	Sister
	Kashmira Navinchandra Bhatt	Sister
	Anila Vora	Sister

*\* Individual forming part of Promoters have not been included in the list of Promoter Group.*

In addition to the above, the following is the list of persons constituting the Promoter Group of the Company in terms of Regulation 2(1)(pp)(v) of the SEBI ICDR Regulations:

1. Sanjay Bhagwanji Bole; and
2. Hemal Paresh Madeka.

**B. Entities forming part of the Promoter Group**

The entities forming part of our Promoter Group are as follows:

1. Fillenpac Industries Private Limited
2. Funfizz Foods
3. Madeka Properties Private Limited
4. Rapid Cut
5. Rolex Industries Private Limited
6. Rolex Properties Private Limited

## OUR GROUP COMPANIES

In terms of the SEBI ICDR Regulations, for the purpose of identification of “group companies”, our Company has considered:

- companies with which there were related party transactions, during the period for which financial information is disclosed in this Prospectus, as covered under IND-AS 24; and
- other companies that are considered material by our Board.

Pursuant to the materiality policy approved by our Board on March 12, 2021 (“**Materiality Policy**”) for the purpose of disclosure as a group company in this Prospectus, a company shall be considered material if subsequent to the date of the Restated Financial Statements of the Company disclosed in this Prospectus, would require disclosure in the financial statements of the Company for subsequent periods as entities covered under IND-AS 24 in addition to the company covered under applicable accounting standards in the latest Restated Financial Statements of the Company included in this Prospectus.

As on the date of this Prospectus, we have one Group Company, the details of which are set forth below.

### (i) **Fillenpac Industries Private Limited (“Fillenpac”)**

Fillenpac Industries Private Limited (“**Fillenpac**”) was incorporated as a private limited company under the Companies Act, 1956 on May 7, 2007. The registered office is situated at Number A 322 7<sup>th</sup> Main Road Peenya, 2<sup>nd</sup> Stage Peenya - Industrial Area, Bengaluru, Karnataka 560058.

#### **Nature of Business**

Fillenpac is currently engaged in business of manufacturing of plastic preforms.

#### *Financial Information*

Set forth below is certain financial information of Fillenpac derived from its audited financial statements for the last three Fiscal Years.

<b>Particulars</b>	<i>(in ₹ million, except per share data)</i>		
	<b>Fiscal 2020</b>	<b>Fiscal 2019</b>	<b>Fiscal 2018</b>
Equity Capital	0.21	0.21	0.21
Reserves and surplus (excluding revaluation reserve)	98.73	105.48	121.20
Total Income	105.10	100.34	89.24
Profit/(Loss) after Tax	(6.76)	(15.71)	(5.87)
Basic EPS	(317.51)	(738.16)	(275.57)
Diluted EPS	(317.51)	(738.16)	(275.57)
Net asset value per share*	4,647.61	4,965.11	5,703.27

\*Book value per share is treated as net asset value per share

**Significant notes of auditors:** Fillenpac has received ₹13,000,000 from M/s. Vesper Pharmaceuticals in connection with an immovable property (“**Property**”) that it agreed to transfer in the name of Mr Suresh Sharma, proprietor of M/s. Vesper Pharmaceuticals. The Property was transferred by Karnataka Industrial Development Board to Fillenpac for ₹ 25,800,000. Fillenpac had paid ₹ 12,900,000 at the time of application for allotment of Property. Later, it paid ₹ 12,908,000 to Karnataka Industrial Development Board from the amount received from M/s. Vesper Pharmaceuticals. M/s. Vesper Pharmaceuticals will pay remaining amount Rs 12,800,000 to Fillenpac at the time of transfer of land in their name. To the said extent, Fillenpac has not complied with provisions of section 73 of the Companies Act, 2013.

#### **Loss making Group Company**

Fillenpac has incurred loss in all the last three fiscal years.

#### **Interest of Group Company in our Company**



(a) ***Business interests***

Fillenpac has no interest in the promotion or any business interest or other interests in our Company.

(b) ***In the properties acquired by our Company in the past three years preceding the filing of this Prospectus with SEBI or proposed to be acquired***

Fillenpac has no interest in the properties acquired by our Company in the three years preceding the filing of this Prospectus with SEBI or proposed to be acquired.

(c) ***In transactions for acquisition of land, construction of building and supply of machinery***

Fillenpac has no interest in any transactions for the acquisition of land, construction of building or supply of machinery.

**Common Pursuits amongst the Group Company with our Company**

There are no common pursuits between Fillenpac and our Company.

**Related Business Transactions with our Group Company and significance on the financial performance of our Company**

For details of related party transactions between our Company and our Group Company till they were related parties under the applicable accounting standard, see “*Related Party Transactions*” on page 159.

**Defunct Group Company**

Fillenpac is not defunct and no application has been made to the relevant registrar of companies for striking off its name during the five years preceding the date of filing of this Prospectus with SEBI.

**Sick Group Company/ Winding up/Insolvency proceedings**

Fillenpac does not fall under the definition of sick industrial companies under the erstwhile Sick Industrial Companies (Special Provisions) Act, 1995, and has not been referred to the Board of Industrial and Financial Reconstruction or the National Company Law Tribunal, and is not under the corporate insolvency resolution process in terms of the Insolvency and Bankruptcy Code, 2016.

**Other confirmations**

The equity shares of our Group Company are not listed on any stock exchange. Further, our Group Company has not failed to list on any stock exchange in India or abroad.

Fillenpac has made no public or rights issue (as defined under the SEBI ICDR Regulations) in the preceding three years.

## **RELATED PARTY TRANSACTIONS**

For details of the related party transactions during Fiscals 2021, 2020 and 2019, as per the requirements under Ind AS 24 see “*Financial Statements – Annexure VII - Notes to Restated Ind AS Summary Statements*” on page 183.

## DIVIDEND POLICY

As on the date of this Prospectus, our Company does not have a formal dividend policy. The declaration and payment of dividends, if any, will be recommended by our Board and approved by our Shareholders, at their discretion, in accordance with provisions of our Articles of Association and applicable law, including the Companies Act (together with applicable rules issued thereunder). Any future determination as to the declaration and payment of dividends will be at the discretion of our Board and will depend on factors that our Board deems relevant, including among others, our contractual obligations, applicable legal restrictions, results of operations, financial condition, revenues, profits, financial condition, capital requirements and business prospects.

In addition, our ability to pay dividends may be impacted by a number of other factors, including restrictive covenants under the loan or financing documents, our Company is currently a party to or may enter into from time to time.

Our Company has not declared any dividend on the Equity Shares or the NCRPS for Fiscal 2019, Fiscal 2020 or Fiscal 2021. Further, our Company has not declared any dividend on the Equity Shares and the NCRPS from October 1, 2020 till the date of this Prospectus. Further, our Company had issued OCRPS on March 3, 2021 which were converted into Equity Shares on July 16, 2021. The OCRPS were not entitled to any dividend during the currency of tenure.

Our Company shall pay dividends, if declared, to the Shareholders in accordance with the provisions of the Companies Act, the Articles of Association and provisions of the SEBI Listing Regulations and other applicable laws. Our Company may pay dividend by cheque, electronic clearance service, as will be approved by our Board in the future. Our Company may also, from time to time, pay interim dividends.

The past trend in relation to our payment of dividends is not necessarily indicative of our dividend trend or dividend policy, if any, in the future, and there is no guarantee that any dividends will be declared or paid in the future. For details, see *“Risk Factors –Our ability to pay dividends in the future will depend on our earnings, financial condition, working capital requirements, capital expenditures and restrictive covenants of our financing arrangements.”* on page 39.

**SECTION V – FINANCIAL INFORMATION**

**FINANCIAL STATEMENTS**

*[This page has been intentionally left blank]*

**Independent Auditors' Examination Report on the Restated Ind AS Summary Statements of Assets and Liabilities as at March 31, 2021, 2020 and 2019 and Restated Ind AS Summary Statement of Profits and Losses (including Other Comprehensive Income), Restated Ind AS Summary Statement of Cash Flows and Restated Ind AS Summary Statement of Changes in Equity for the year ended March 31, 2021, 2020 and 2019, Summary Statement of Significant Accounting Policies and other explanatory information of Rolex Rings Limited (collectively, the "Restated Ind AS Summary Statements").**

To  
**The Board of Directors**  
**Rolex Rings Limited**  
**Gondal Road, Village-Kotharia,**  
**Dist. Rajkot - 360 004, Gujarat**

Dear Sirs:

1. We have examined the attached Restated Ind AS Summary Statements of Rolex Rings Limited (Formerly known as Rolex Rings Private Limited) (the "Company") annexed to this report and prepared by the Company for the purpose of inclusion in the Red Herring Prospectus ("RHP") and the Prospectus in connection with its proposed Initial Public Offer ("IPO"). The Restated Ind AS Summary Statements, which have been approved by the Board of Directors of the Company at their meeting held on July 18, 2021 have been prepared in accordance with the requirements of:
  - a) Section 26 of Part I of Chapter III of the Companies Act 2013 (the "Act");
  - b) The Securities and Exchange Board of India (Issue of Capital and Disclosure Requirements) Regulations, 2018, as amended ("ICDR Regulations"); and
  - c) The Guidance Note on Reports in Company Prospectuses (Revised 2019) (as amended) issued by the Institute of Chartered Accountants of India ("ICAI"), (the "Guidance Note").

**Management's Responsibility for the Restated Ind AS Summary Statements**

2. The preparation of the Restated Ind AS Summary Statements, which are to be included in the RHP and the Prospectus is the responsibility of the Management of the Company. The Restated Ind AS Summary Statements have been prepared by the Management of the Company on the basis of preparation, as stated in paragraph 2(i) of Annexure V to the Restated Ind AS Summary Statements. The Management's responsibility includes designing, implementing and maintaining adequate internal control relevant to the preparation and presentation of the Restated Ind AS Summary Statements. The Management is also responsible for identifying and ensuring that the Company complies with the Act, ICDR Regulations and the Guidance Note.

**Auditors' Responsibilities**

3. We have examined such Restated Ind AS Summary Statements taking into consideration:
  - a) the terms of reference and terms of our engagement agreed with you vide our engagement letter dated February 04, 2021, requesting us to carry out the assignment, in connection with the proposed IPO of the Company;
  - b) the Guidance Note. The Guidance Note also requires that we comply with ethical requirements of the Code of Ethics Issued by ICAI.
  - c) concepts of test checks and materiality to obtain reasonable assurance based on the verification of evidence supporting the Restated Ind AS Summary Statements; and
  - d) The requirements of Section 26 of the Act and the ICDR Regulations.Our work was performed solely to assist you in meeting your responsibilities in relation to your compliance with the Act and the ICDR Regulations in connection with the IPO.
4. The Company proposes to make an IPO which comprises of offer for sale by certain existing shareholders and fresh issue of its equity shares of Rs. 10 each at such premium arrived at by the book building process (referred to as the 'Issue'), as may be decided by the Company's Board of Directors.

## Restated Ind AS Summary Statements

5. These Restated Ind AS Summary Statements have been compiled by the management of the Company from:
  - a) Audited Ind AS financial statements of the Company as at and for the year ended March 31, 2021 prepared in accordance with the Indian Accounting Standard (referred to as “Ind AS”) as prescribed under Section 133 of the Act read with Companies (Indian Accounting Standards) Rules 2015, as amended and other accounting principles generally accepted in India, which have been approved by the Board of Directors at their meeting held on July 18, 2021.
  - b) Audited financial statements of the Company as at and for the year ended March 31, 2020, which were prepared in accordance with accounting principles generally accepted in India (“Indian GAAP”) at the relevant time as prescribed under Section 133 of the Act read with Companies (Accounts) Rules 2014 (as amended), which have been approved by the Board of Directors at their meeting held on November 12, 2020. The management of the Company has adjusted financial information included in such Indian GAAP financial statements for the year ended March 31, 2020, using recognition and measurement principles of Ind AS and has included such adjusted financial information as comparative financial information in the financial statements for the year ended March 31, 2021 as referred to in para 5(a) above;
  - c) Audited financial statements of the Company as at and for the year ended March 31, 2019, which were prepared in accordance with Indian GAAP at the relevant time which have been approved by the Board of Directors at their meeting held on September 30, 2019. The Restated Ind AS Summary Statements also includes Proforma Ind AS Summary Statements for the year ended March 31, 2019 which have been prepared by the management from the audited financial statements of the Company as at and for the year ended March 31, 2019; have been adjusted by the management as described in Note 38 of Annexure VII to the Restated Ind AS Summary Statements to make them compliant with recognition and measurement under Ind AS.
6. For the purpose of our examination, we have relied on auditors’ reports issued by us, dated July 18, 2021, November 12, 2020 and September 30, 2019 on the financial statements of the Company for and as at and for each of the years ended March 31, 2021, March 31, 2020 and March 31, 2019 respectively, as referred in Paragraph 5 above.
7. Based on our examination and according to the information and explanations given to us, we report that Restated Ind AS Summary Statements of the Company:
  - i. have been prepared after incorporating adjustments for the changes in accounting policies, and regrouping / reclassifications retrospectively in the financial years ended March 31, 2020 and 2019 to reflect the same accounting treatment as per the accounting policies and grouping/classifications followed as at and for the year ended March 31, 2021;
  - ii. have been prepared after incorporating proforma adjustments to the audited Indian GAAP financial statements as at and for the year ended March 31, 2019 as described in Note 38 of Annexure VII to the Restated Ind AS Summary Statements;
  - iii. does not contain any qualifications requiring adjustments. Qualifications in the Companies (Auditor’s Report) Order, 2016 issued by the Central Government of India in terms of sub section (11) of section 143 of the Act, which do not require any corrective adjustments in the Restated Ind AS Summary Statements have been disclosed in Annexure VI -C to the Restated Ind AS Summary Statements; and
  - iv. have been prepared in accordance with the Act, ICDR Regulations and the Guidance Note.
8. We have not audited any financial statements of the Company as of any date or for any period subsequent to March 31, 2021. Accordingly, we express no opinion on the financial position, results of operations, cash flows and statement of changes in equity of the Company as of any date or for any period subsequent to March 31, 2021.

9. This report should not in any way be construed as a reissuance or re-dating of any of the previous audit reports issued by us, nor should this report be construed as a new opinion on any of the financial statements referred to herein.
10. The Restated Ind AS Summary Statements do not reflect the effects of events that occurred subsequent to the audited financial statements mentioned in paragraph 5 above.
11. We have no responsibility to update our report for events and circumstances occurring after the date of the report.
12. Our report is intended solely for use of the Board of Directors for inclusion in the RHP and Prospectus to be filed with Securities and Exchange Board of India, National Stock Exchange of India Limited, BSE Limited and Registrar of Companies, in connection with the proposed IPO. Our report should not be used, referred to, or distributed for any other purpose. Accordingly, we do not accept or assume any liability or any duty of care for any other purpose or to any other person to whom this report is shown or into whose hands it may come.

Yours Truly,

For S R B C & CO LLP  
Chartered Accountants  
ICAI Firm Registration No: 324982E/E300003

per Sukrut S Mehta  
Partner  
Membership number: 101974  
UDIN: 21101974AAAADI8655  
Place of Signature: Ahmedabad  
Date: July 18, 2021

Annexure I  
Restated Ind AS Summary Statement of Assets and Liabilities

Particulars	Annexure VII Note	As at March 31, 2021	As at March 31, 2020	As at March 31, 2019 (Proforma)
<b>Assets</b>				
<b>Non-current assets</b>				
Property, plant and equipment	3.1	3,713.93	3,730.30	3,808.40
Capital work in progress	3.1	11.52	-	9.52
Right-of-use assets	3.2	0.50	0.66	0.82
Intangible assets	3.3	9.48	11.70	14.14
<b>Financial assets</b>				
a) Loans	4	-	25.00	33.30
b) Other financial assets	5	139.63	33.70	125.00
Income tax assets (net)		19.66	19.50	19.66
Other non-current assets	9	288.23	111.29	131.41
		<u>4,182.95</u>	<u>3,932.15</u>	<u>4,142.25</u>
<b>Current assets</b>				
Inventories	6	1,710.73	1,305.71	1,602.01
<b>Financial assets</b>				
a) Loans	4	0.76	30.87	1.23
b) Trade receivables	7	1,708.01	1,276.72	1,814.96
c) Cash and cash equivalents	8.1	46.12	12.45	1.38
d) Bank balances other than Cash and cash equivalents	8.2	58.05	151.91	45.25
e) Other financial assets	5	67.96	59.99	102.00
Other current assets	9	194.66	91.93	113.49
		<u>3,786.29</u>	<u>2,929.58</u>	<u>3,680.32</u>
<b>Total assets</b>		<u><u>7,969.24</u></u>	<u><u>6,861.73</u></u>	<u><u>7,822.57</u></u>
<b>Equity and liabilities</b>				
<b>Equity</b>				
Equity share capital	10.1	239.81	239.81	239.81
Other equity	11	3,327.52	2,441.24	1,913.63
Total equity		<u>3,567.33</u>	<u>2,681.05</u>	<u>2,153.44</u>
<b>Liabilities</b>				
<b>Non-current liabilities</b>				
<b>Financial liabilities</b>				
a) Borrowings	12.1	323.45	442.43	913.40
b) Lease liabilities	34	0.67	0.94	1.18
Income tax liabilities (net)		179.31	179.31	170.53
Deferred tax liabilities (net)	17	324.06	569.45	506.17
Provisions	16	31.09	30.89	23.40
		<u>858.58</u>	<u>1,223.02</u>	<u>1,614.68</u>
<b>Current liabilities</b>				
<b>Financial Liabilities</b>				
a) Borrowings	12.2	1,835.72	1,939.26	2,343.25
b) Lease liabilities	34	0.39	0.39	0.39
c) Trade payables				
- total outstanding dues of micro and small enterprises	13	19.20	14.76	25.43
- total outstanding dues of creditors other than micro and small enterprises	13	1,157.15	723.71	887.56
d) Other financial liabilities	14	433.97	261.22	671.18
Other liabilities	15	14.75	8.43	13.23
Provisions	16	7.27	7.19	6.52
Income tax liabilities (net)		74.88	2.70	106.89
		<u>3,543.33</u>	<u>2,957.66</u>	<u>4,054.45</u>
<b>Total liabilities</b>		<u><u>4,401.91</u></u>	<u><u>4,180.68</u></u>	<u><u>5,669.13</u></u>
<b>Total equity and liabilities</b>		<u><u>7,969.24</u></u>	<u><u>6,861.73</u></u>	<u><u>7,822.57</u></u>

The above Statement should be read with the Annexure V - Significant accounting policies and explanatory notes to Restated Ind AS Summary Statements, Annexure VI - Statement of Restatement Adjustments to Audited Financial Statements and Annexure VII - Notes to Restated Ind AS Summary Statements.

As per our report of even date

For S R B C & CO LLP  
Chartered Accountants  
ICAI Firm Registration No: 324982E/E300003

For and on behalf of the Board of Directors of  
Rolex Rings Limited (formerly known as Rolex Rings Private Limited)  
CIN: U28910GJ2003PLC041991

per Sukrut Mehta  
Partner  
Membership number: 101974

Manesh Madeka      Bhautik Madeka      CS Hardik Gandhi      Hiren Doshi  
Managing Director      Director      Company Secretary      Chief financial officer  
DIN: 01629788      DIN: 01761543

Place: Ahmedabad  
Date: July 18, 2021

Place: Rajkot      Place: Rajkot      Place: Rajkot      Place: Rajkot  
Date: July 18, 2021      Date: July 18, 2021      Date: July 18, 2021      Date: July 18, 2021



Annexure II  
Restated Ind AS Summary Statement of Profit and Loss

Particulars	Annexure VII Note	Year ended March 31, 2021	Year ended March 31, 2020	Year ended March 31, 2019 (Proforma)
<b>Income</b>				
Revenue from operations	18	6,163.32	6,659.94	9,043.23
Other income	19	34.25	93.38	69.31
<b>Total income (I)</b>		<b>6,197.57</b>	<b>6,753.32</b>	<b>9,112.54</b>
<b>Expenses</b>				
Cost of raw materials and components consumed	20	3,165.94	3,137.41	4,529.36
(Increase) / Decrease in inventories of finished goods and work-in-progress	21	(291.60)	155.92	(190.06)
Employee benefits expense	22	518.66	526.59	608.06
Finance costs	23	116.99	321.69	420.19
Depreciation and amortisation expense	24	254.09	265.24	254.40
Other expenses	25	1,681.64	1,625.64	2,084.99
<b>Total expenses (II)</b>		<b>5,445.72</b>	<b>6,032.49</b>	<b>7,706.94</b>
<b>Restated profit before tax (III) = (I - II)</b>		<b>751.85</b>	<b>720.83</b>	<b>1,405.60</b>
<b>Tax expense</b>				
Current tax expenses	17	130.42	127.17	308.90
Deferred tax charge/(credit)	17	(248.12)	64.25	506.29
<b>Total tax expense (IV)</b>		<b>(117.70)</b>	<b>191.42</b>	<b>815.19</b>
<b>Restated profit for the year (V) = (III - IV)</b>		<b>869.55</b>	<b>529.41</b>	<b>590.41</b>
<b>Other comprehensive income (OCI)</b>				
Items not to be reclassified to profit or loss in subsequent year :				
Re-measurement gains/ (losses) on defined benefit plans		7.81	(2.77)	(0.35)
Less: Income tax relating to these items		(2.73)	0.97	0.12
<b>Restated total other comprehensive income for the year, net of tax (VI)</b>		<b>5.08</b>	<b>(1.80)</b>	<b>(0.23)</b>
<b>Restated total comprehensive income for the year, net of tax (VII)=(V+VI)</b>		<b>874.63</b>	<b>527.61</b>	<b>590.18</b>
<b>Restated Earnings per equity share (face value Rs.10)</b>	26			
Computed on the basis of restated profit for the year (In Rs.)				
- Basic		36.26	22.08	24.62
- Diluted		35.96	22.08	24.62

The above Statement should be read with the Annexure V - Significant accounting policies and explanatory notes to Restated Ind AS Summary Statements, Annexure VI - Statement of Restatement Adjustments to Audited Financial Statements and Annexure VII - Notes to Restated Ind AS Summary Statements.

As per our report of even date.

For S R B C & CO LLP  
Chartered Accountants  
ICAI Firm Registration No.: 324982E/E300003

For and on behalf of the Board of Directors of  
Rolex Rings Limited (formerly known as Rolex Rings Private Limited)  
CIN: U28910GJ2003PLC041991

per Sukrut Mehta  
Partner  
Membership number: 101974

Manesh Madeka    Bhautik Madeka    CS Hardik Gandhi    Hiren Doshi  
Managing Director    Director    Company Secretary    Chief financial officer  
DIN: 01629788    DIN: 01761543

Place: Ahmedabad  
Date: July 18, 2021

Place: Rajkot    Place: Rajkot    Place: Rajkot    Place: Rajkot  
Date: July 18, 2021    Date: July 18, 2021    Date: July 18, 2021    Date: July 18, 2021

Annexure III  
Restated Ind AS Summary Statement of Cash Flows

	Year ended March 31, 2021	Year ended March 31, 2020	Year ended March 31, 2019 (Proforma)
Cash flow from operating activities			
Restated profit before tax	751.85	720.83	1,405.60
Adjustment to reconcile restated profit before tax to net cash flows			
Depreciation and amortisation expense	254.09	265.24	254.40
Provision for impairment of financial assets (net)	-	-	3.33
Gain/(loss) on sale of Property, Plant & Equipment (net)	(0.72)	0.45	(4.27)
Finance cost	116.99	321.69	420.19
Unrealised (gain)/loss on foreign exchange (net)	(29.82)	13.30	(24.91)
Interest income	(14.74)	(14.75)	(14.55)
Operating profit before working capital changes	1,077.65	1,306.76	2,039.79
Working capital adjustments			
Increase/ (decrease) in trade payables	447.96	(184.01)	(58.33)
Increase in other financial liabilities, other liabilities and provisions	22.49	1.16	8.20
(Increase)/ decrease in trade receivables	(417.85)	611.18	168.60
(Increase)/ decrease in inventories	(405.01)	296.29	6.67
(Increase)/ decrease in loans, other financial assets, and other assets	(74.70)	28.82	121.99
Cash generated from operations	650.54	2,060.20	2,286.92
Direct taxes paid (net of refunds)	(58.40)	(222.43)	(348.87)
Net cash flows from operating activities (A)	592.14	1,837.77	1,938.05
Cash flows from investing activities			
Purchase of property, plant and equipment and intangible assets (including capital advances) and Capital Work in Progress	(387.29)	(160.94)	(367.41)
Proceeds from sale of property, plant and equipment	2.43	3.80	4.57
Investment in margin money deposits	(103.06)	(106.66)	(135.94)
Redemption of margin money deposits having original maturity more than 12 months	93.86	91.03	135.96
Inter corporate deposit (given to) / received from related party	25.00	8.30	(8.30)
Interest received	5.98	22.77	7.63
Net cash flows (used in) investing activities (B)	(363.08)	(141.70)	(363.49)
Net cash flow from financing activities			
Repayment of short-term borrowings (net)	(97.24)	(480.72)	(257.68)
Repayment of long-term borrowings	(223.54)	(866.68)	(909.72)
Proceeds from long-term borrowings	208.10	-	-
Proceeds from issue of Optionally Convertible Redeemable Preference Shares	26.30	-	-
Payment of principal portion of lease liabilities	(0.39)	(0.39)	(0.39)
Interest paid	(108.62)	(337.21)	(412.33)
Net cash flows (used in) financing activities (C)	(195.39)	(1,685.00)	(1,580.12)
Net (decrease)/ increase in cash and cash equivalents (A + B + C)	33.67	11.07	(5.56)
Cash and cash equivalents at the beginning of the year	12.45	1.38	6.94
Cash and cash equivalents at the end of the year	46.12	12.45	1.38
Components of cash and cash equivalents			
Cash on hand	0.42	0.35	0.45
Balances with banks			
- on current accounts	45.70	12.10	0.93
Total cash and cash equivalents (refer note 8.1)	46.12	12.45	1.38

The above Statement should be read with the Annexure V - Significant accounting policies and explanatory notes to Restated Ind AS Summary Statements, Annexure VI - Statement of Restatement Adjustments to Audited Financial Statements and Annexure VII - Notes to Restated Ind AS Summary Statements.

Note:

1. The cash flow statement has been prepared under the indirect method as set out in Indian Accounting Standard (Ind AS) 7 on Statement of Cash Flows issued by the Institute of Chartered Accountants of India.

2. Figures in brackets represents outflow.

As per our report of even date

For S R B C & CO LLP  
Chartered Accountants  
ICAI Firm Registration No.: 324982E/E300003

For and on behalf of the Board of Directors of  
Rolex Rings Limited (formerly known as Rolex Rings Private Limited)  
CIN: U28910GJ2003PLC041991

per Sukrut Mehta  
Partner  
Membership number: 101974

Manesh Madeka      Bhautik Madeka      CS Hardik Gandhi      Hiren Doshi  
Managing Director      Director      Company Secretary      Chief financial officer  
DIN: 01629788      DIN: 01761543

Place: Ahmedabad  
Date: July 18, 2021

Place: Rajkot      Place: Rajkot      Place: Rajkot      Place: Rajkot  
Date: July 18, 2021      Date: July 18, 2021      Date: July 18, 2021      Date: July 18, 2021

Annexure IV

Restated Ind AS Summary Statement of Changes in Equity

(A) Equity Share Capital:

Equity shares of Rs. 10 each issued, subscribed and fully paid

Particulars	No. of Shares	Amount
As at April 01, 2018 (Proforma)	2,39,81,090	239.81
Issue of shares during the year	-	-
As at March 31, 2019 (Proforma)	2,39,81,090	239.81
Issue of shares during the year	-	-
As at March 31, 2020	2,39,81,090	239.81
Issue of shares during the year	-	-
As at March 31, 2021	2,39,81,090	239.81

(B) Other Equity

Particulars	Attributable to equity shareholders			Total other equity
	Reserves and surplus			
	Equity Component of Compound Financial Instruments	Securities premium	Retained earnings	
As at April 1, 2018 (Proforma)	84.53	1,626.14	(387.22)	1,323.45
Restated profit for the year (net of taxes)	-	-	590.41	590.41
Restated Other comprehensive income for the year (net of taxes)	-	-	(0.23)	(0.23)
As at March 31, 2019 (Proforma)	84.53	1,626.14	202.96	1,913.63
Restated profit for the year (net of taxes)	-	-	529.41	529.41
Restated Other comprehensive income for the year (net of taxes)	-	-	(1.80)	(1.80)
Balance as at March 31, 2020	84.53	1,626.14	730.57	2,441.24
Restated profit for the year (net of taxes)	-	-	869.55	869.55
Restated Other comprehensive income for the year (net of taxes)	-	-	5.08	5.08
On issue of Optionally Convertible Redeemable Preference Shares during the year	11.65	-	-	11.65
Balance as at March 31, 2021	96.18	1,626.14	1,605.20	3,327.52

The above Statement should be read with the Annexure V - Significant accounting policies and explanatory notes to Restated Ind AS Summary Statements, Annexure VI - Statement of Restatement Adjustments to Audited Financial Statements and Annexure VII - Notes to Restated Ind AS Summary Statements.

As per our report of even date

For S R B C & CO LLP  
Chartered Accountants  
ICAI Firm Registration Number: 324982E/E300003

For and on behalf of the Board of Directors of  
Rolex Rings Limited (formerly known as Rolex Rings Private Limited)  
CIN: U28910GJ2003PLC041991

per Sukrut Mehta  
Partner  
Membership number: 101974  
Place: Ahmedabad  
Date: July 18, 2021

Manesh Madeka Director DIN: 01629788 Place: Rajkot Date: July 18, 2021	Bhautik Madeka Director DIN: 01761543 Place: Rajkot Date: July 18, 2021	CS Hardik Gandhi Company Secretary Place: Rajkot Date: July 18, 2021	Hiren Doshi Chief financial officer Place: Rajkot Date: July 18, 2021
--	---	---	--

## 1 Corporate Information

Rolex Rings Limited (formerly known as Rolex Rings Private Limited) ('the Company') is a public company domiciled in India which was incorporated on February 13, 2003 under the provision of the Companies Act, 1956. The registered office of the Company is located at B/h. Glowtech Steel Private Limited, Gondal Road, Village-Kotharia, Rajkot. The company is engaged in manufacturing of forged & machined bearing rings and automotive components.

The Company has converted from a Private Limited Company to Public Limited Company, pursuant to a special resolution passed in the extraordinary general meeting of the shareholders of the Company held on February 19, 2021 and consequently the name of the Company has changed to Rolex Rings Limited pursuant to a fresh certificate of incorporation issued by ROC on March 10, 2021.

The Company's Restated Ind AS Summary Statements for the year ended on March 31, 2021, for year ended March 31, 2020 and March 31, 2019 (Proforma) were approved for issue in accordance with a resolution of the directors on July 18, 2021.

## 2 Significant accounting policies

### i) Basis of preparation of financial statements

The Restated Ind AS Summary Statements of the Company comprise of the Restated Ind AS Summary Statement of Assets and Liabilities as at March 31, 2021, March 31, 2020, March 31, 2019 (Proforma), the related Restated Ind AS Summary Statement of Profit and Loss (including Other Comprehensive Income), the Restated Ind AS Summary Statement of Cash Flows and the Restated Ind AS Summary Statement of Changes in Equity for the year ended March 31, 2021, March 31, 2020, and March 31, 2019 (Proforma), and the Significant Accounting Policies and explanatory notes (collectively, the 'Restated Ind AS Summary Statements' or 'Statements').

These Statements have been prepared by the Management for the purpose of preparation of the restated financial statements as required under the Securities and Exchange Board of India (Issue of Capital and Disclosure Requirements) Regulations, 2018, as amended from time to time, issued by the Securities and Exchange Board of India ('SEBI') on 11 September 2018, in pursuance of the Securities and Exchange Board of India Act, 1992 ("ICDR Regulations") for the purpose of inclusion in the Red Herring Prospectus ('RHP') in connection with its proposed initial public offering of equity shares of face value of Rs. 10 each of the Company comprising a fresh issue of equity shares and an offer for sale of equity shares held by the selling shareholders (the "Offer"), prepared by the Company in terms of the requirements of:

(a) Section 26 of Part I of Chapter III of the Companies Act, 2013 (the "Act");

(b) The Securities and Exchange Board of India (Issue of Capital and Disclosure Requirements) Regulations, 2018 as amended from time to time; and

(c) The Guidance Note on Reports in Company Prospectuses (Revised 2019) issued by the Institute of Chartered Accountants of India (ICAI) (the "Guidance Note").

The Restated Ind AS Summary Statements have been compiled from:

- Audited Ind AS financial statements of the Company as at and for the year ended March 31, 2021 prepared in accordance with the Indian Accounting Standard (referred to as "Ind AS") as prescribed under Section 133 of the Act read with Companies (Indian Accounting Standards) Rules 2015, as amended and other accounting principles generally accepted in India, which have been approved by the Board of Directors at their meeting held on July 18, 2021. The financial statements for the year ended March 31, 2021 are the first financial statements that the company has prepared in accordance with Ind AS. The date of transition is April 1, 2019. The transition to Ind AS has been carried out from the accounting standards notified under section 133 of the Act read with Companies (Accounts) Rules, 2014 (as amended), which is considered as the previous GAAP for the purpose of Ind AS 101. Refer to Note 38 to Restated Ind AS Summary Statements for the detail information on how the company transitioned to Ind AS.

- Audited financial statements of the Company as at and for year ended March 31, 2020 prepared in accordance with accounting principles generally accepted in India ("Indian GAAP") including the Companies (Accounting Standards) Rules, 2006 (as amended) specified under Section 133 of the Act read with Companies (Accounts) Rules 2014 (as amended), which have been approved by the Board of Directors at their meeting held on November 12, 2020. The Restated Ind AS Summary Statements also includes Ind AS Summary Statements for the year ended March 31, 2020 which have been prepared from the audited financial statements of the Company as at and for the year ended March 31, 2020; have been adjusted as described in Note 38 of Annexure VII to the Restated Ind AS Summary Statements to make them compliant with recognition and measurement under Ind-AS, and has included such adjusted financial information as comparative financial information in the financial statements for the year ended March 31, 2021.

- Audited financial statements of the Company as at and for the year ended March 31, 2019, which were prepared in accordance with accounting principles generally accepted in India ("Indian GAAP") including the Companies (Accounting Standards) Rules, 2006 (as amended) specified under Section 133 of the Act read with Companies (Accounts) Rules 2014 (as amended), which have been approved by the Board of Directors at their meeting held on September 30, 2019. The Restated Ind AS Summary Statements also includes proforma Ind AS Summary Statements for the year ended March 31, 2019 which have been prepared from the audited financial statements of the Company as at and for the year ended March 31, 2019; have been adjusted as described in Note 38 of Annexure VII to the Restated Ind AS Summary Statements to make them compliant with recognition and measurement under Ind-AS

The proforma summary statements of the Company as at and for the year ended March 31, 2019 (Proforma) is prepared in accordance with requirements of SEBI Circular and the Guidance Note. For the purpose of Proforma Financial Statements for the year ended March 31, 2019 (Proforma) the Company has followed the same accounting policy and accounting policy choices (both mandatory exceptions and optional exemptions availed as per Ind AS 101) as initially adopted on transition date i.e. April 01, 2019. Accordingly, suitable restatement adjustments (both re-measurements and reclassifications) in the accounting heads are made to the proforma summary statements for the year ended March 31, 2019 (Proforma) in following accounting policies and accounting policy choices (both mandatory exceptions and optional exemptions) (refer note 38 for other exemptions and exceptions) consistent with that used at the date of transition to Ind AS (i.e. April 01, 2019).

This note provides a list of the significant accounting policies adopted in the preparation of these Restated Ind AS Summary Statements. These policies have been consistently applied to all the years presented, unless otherwise stated.

ii) Basis of Measurement

The financial statements have been prepared on the going concern basis on a historical cost convention except for certain financial instruments that are measured at fair value at the end of each reporting year.

iii) Functional currency and rounding of amounts

The financial statements are presented in Indian National currency Rupee (₹) which is the functional currency of the Company, and all values are rounded to the nearest Million, except where otherwise indicated.

iv) Use of estimates and judgements

The preparation of the Company's financial statements requires management to make estimates and assumptions that affect the reported amounts of revenues, expenses, assets and liabilities, and the accompanying disclosures, and the disclosure of contingent liabilities. Uncertainty about these assumptions and estimates could result in outcomes that require a material adjustment to the carrying amount of assets or liabilities affected in future periods.

Estimates and Assumptions:

The key assumptions concerning the future and other key sources of estimation uncertainty at the reporting date, that have a significant risk of causing a material adjustment to the carrying amounts of assets and liabilities within the next financial year, are described below. The Company based its assumptions and estimates on parameters available when the financial statements were prepared. Existing circumstances and assumptions about future developments, however, may change due to market changes or circumstances arising that are beyond the control of the Company. Such changes are reflected in the assumptions when they occur.

Defined benefit plans (gratuity benefits):

A liability in respect of defined benefit plans is recognised in the balance sheet, and is measured as the present value of the defined benefit obligation at the reporting date less the fair value of the plan's assets. The present value of the defined benefit obligation is based on expected future payments which arise from the fund at the reporting date, calculated annually by independent actuaries. Consideration is given to expected future salary levels, experience of employee departures and periods of service.

Useful economic lives of Property, plant and equipment:

Property, plant and equipment as disclosed in note 3.1 are depreciated over their useful economic lives. Management reviews the useful economic lives at least once a year and any changes could affect the depreciation rates prospectively and hence the asset carrying values.

v) Current vs Non Current Classification

The Company presents assets and liabilities in the statement of Assets and Liabilities based on current/ noncurrent classification.

An asset is treated as current when it is:

- Expected to be realised or intended to be sold or consumed in normal operating cycle
- Held primarily for the purpose of trading
- Expected to be realised within twelve months after the reporting period, or
- Cash or cash equivalent unless restricted from being exchanged or used to settle a liability for at least twelve months after the reporting period

A liability is treated as current when it is:

- Expected to be settled in normal operating cycle
- Held primarily for the purpose of trading
- Due to be settled within twelve months after the reporting period, or
- There is no unconditional right to defer the settlement of the liability for at least twelve months after the reporting period

All other assets and liabilities are classified as non-current assets and liabilities. Deferred tax assets and liabilities are classified as non-current assets and liabilities.

The operating cycle is the time between the acquisition of assets for processing and their realization in cash and cash equivalents. The Company has identified twelve months as its operating cycle.

vi) Inventories

Inventories are valued at the lower of cost and net realisable value.

Cost of raw materials is determined on a specific identification price basis. However, materials and other items held for use in the production of inventories are not written down below cost if the finished products in which they will be incorporated are expected to be sold at or above cost.

Cost of finished goods and work in progress includes direct materials and labour and a proportion of manufacturing overheads based on normal operating capacity. Material cost is valued at moving weighted average cost.

Cost of spares and consumables is determined on a moving weighted average cost basis.

Scrap is valued at estimated realisable value.

Net realizable value is the estimated selling price in the ordinary course of business, less estimated costs of completion and estimated costs necessary to make the sale.

vii) Cash and cash equivalents

Cash and cash equivalent in the balance sheet comprise cash at banks and on hand and short-term deposits with an original maturity of three months or less, that are readily convertible to a known amount of cash and subject to an insignificant risk of changes in value.

For the purpose of the Statement of cash flows, cash and cash equivalents consist of cash and short-term deposits, as defined above, net of outstanding bank overdrafts as they are considered an integral part of the Company's cash management.

viii) Property, Plant and Equipment

Property, plant and equipment are stated at actual costs, net of accumulated depreciation and accumulated impairment losses, if any. The cost comprises purchase price, borrowing costs if capitalization criteria are met, directly attributable cost of bringing the asset to its working condition for the intended use and initial estimate of decommissioning, restoring and similar liabilities.

Any trade discounts and rebates are deducted in arriving at the purchase price. Such cost includes the cost of replacing part of the plant and equipment. When significant parts of property, plant and equipment are required to be replaced at intervals, the Company depreciates them separately based on their specific useful lives. Likewise, when a major inspection is performed, its cost is recognised in the carrying amount of the plant and equipment as a replacement if the recognition criteria are satisfied. All other repair and maintenance costs are recognised in profit or loss as incurred.

Items of stores and spares that meet the definition of property, plant and equipment are capitalized at cost and depreciated over their useful life. Otherwise, such items are classified as a part of inventories.

Properties in course of construction for production, supply or administrative purposes are carried at cost, less recognised impairment losses. All the direct expenditures related to the implementation including incidental expenditure incurred during the period of implementation of a project, till it is commissioned is accounted as Capital Work in progress (CWIP) and such properties are classified as appropriate categories of Property, plant and equipment when completed and ready for the intended use.

An item of property, plant and equipment and any significant part initially recognised is derecognised upon disposal or when no future economic benefits are expected from its use or disposal. Any gain or loss arising on derecognition of the asset (calculated as the difference between the net disposal proceeds and the carrying amount of the asset) is included in the statement of profit and loss when the asset is derecognised.

On transition to Ind AS, the company has elected to continue with the carrying values of all of its property, plant and equipments recognised as on 01 April, 2017 measured as per the previous GAAP, and use that carrying values as the deemed cost of such property, plant and equipment.

ix) Depreciation on property, plant and equipment

Depreciation on property, plant and equipment is calculated on a written down value basis using the rates arrived at, based on the useful lives estimated by the management. The management, on the basis of internal technical assessment of usage pattern, believes that the useful lives as mentioned below best represents the period over which management expects to use these assets. Hence, the useful lives in respect of certain assets are different from the useful lives as prescribed under Part C of Schedule II of the Companies Act, 2013.

Class of Assets	Useful Life Estimated by Management
Buildings	30
Plant & machinery	25
Vehicles	10
Furniture and fixtures	8
Computers	3
Windmill	22

The estimated useful lives and residual values of the property, plant and equipment are reviewed at the end of each reporting year, with the effect of any changes in estimate accounted for on a prospective basis.

Depreciation on items of property, plant and equipment acquired / disposed off during the year is provided on pro-rata basis with reference to the date of addition / disposal.

- x) Leases  
The company assesses at contract inception whether a contract is, or contains, a lease. That is, if the contract conveys the right to control the use of an identified asset for a period of time in exchange for consideration.

Company as Lessee -

Company's leased assets comprises of lands. The company applies a single recognition and measurement approach for all leases, except for short-term leases and leases of low-value assets. The company recognises lease liabilities to make lease payments and right-of-use assets representing the right to use the underlying assets.

a. Right-of-use assets

The company recognises right-of-use assets at the commencement date of the lease (i.e., the date the underlying asset is available for use).

Right-of-use assets are measured at cost, less any accumulated depreciation and impairment losses, and adjusted for any remeasurement of lease liabilities. The cost of right-of-use assets includes the amount of lease liabilities recognised, initial direct costs incurred, and lease payments made at or before the commencement date less any lease incentives received.

Right-of-use assets are depreciated on a straight-line basis over the lease term and the estimated useful lives of the assets, as follows:

- Right-of-use Assets (Leasehold lands) : 20 years

The right-of-use assets are also subject to impairment. Refer to the accounting policies in section xii (b) Impairment of non-financial assets.

b. Lease liabilities

At the commencement date of the lease, the company recognises lease liabilities measured at the present value of lease payments to be made over the lease term. The lease payments include fixed payments (including in substance fixed payments) less any lease incentives receivable, variable lease payments that depend on an index or a rate, and amounts expected to be paid under residual value guarantees. The lease payments also include the exercise price of a purchase option reasonably certain to be exercised by the

In calculating the present value of lease payments, the company uses its incremental borrowing rate at the lease commencement date because the interest rate implicit in the lease is not readily determinable. After the commencement date, the amount of lease liabilities is increased to reflect the accretion of interest and reduced for the lease payments made. In addition, the carrying amount of lease liabilities is remeasured if there is a modification, a change in the lease term, a change in the lease payments (e.g., changes to future payments resulting from a change in an index or rate used to determine such lease payments) or a change in the assessment of an option to purchase the underlying asset.

Short-term leases and leases of low-value assets

The Company applies the short-term lease recognition exemption to its short-term leases (i.e., those leases that have a lease term of 12 months or less from the commencement date with no option for extension and do not contain a purchase option). It also applies the lease of low-value assets recognition exemption to leases that are considered to be low value. Lease payments on short-term leases and leases of low-value assets are recognised as expense on a straight-line basis over the lease term.

Company as Lessor -

Leases in which the company does not transfer substantially all the risks and rewards incidental to ownership of an asset are classified as operating leases. Rental income arising is accounted for on a straight-line basis over the lease terms and is included in other income in the statement of profit or loss due to its operating nature. Initial direct costs incurred in negotiating and arranging an operating lease are added to the carrying amount of the leased asset and recognised over the lease term on the same basis as rental income.

- xi) Intangible assets

Intangible assets acquired separately includes softwares are measured on initial recognition at cost. Following initial recognition, intangible assets are carried at cost less accumulated amortization and accumulated impairment losses, if any.

On transition to Ind AS, the company has elected to continue with the carrying values of its intangible assets recognised as on 01 April 2017 measured as per the previous GAAP, and use that carrying values as the deemed cost of such intangible assets.

Intangible assets are amortized on a straight line basis over the estimated useful economic life of 5 years. The amortization period and the amortization method are reviewed at least at each financial year end. If the expected useful life of the asset is significantly different from previous estimates, the amortization period is changed accordingly.

xii) Impairment of assets

a) Impairment of Financial Instruments/ Financial Assets-

The company recognises loss allowances for expected credit losses on Financial assets measured at Amortised costs.

For trade receivables and contract assets, the company applies a simplified approach in calculating ECLs. Therefore, the company does not track changes in credit risk, but instead recognises a loss allowance based on lifetime ECLs at each reporting date. The company has established a provision matrix that is based on its historical credit loss experience, adjusted for forward-looking factors specific to the debtors and the economic environment.

b) Impairment on Non financial Assets -

The company assesses at each reporting date whether there is an indication that an asset may be impaired. If any indication exists, or when annual impairment testing for an asset is required, the company estimates the asset's recoverable amount.

An asset's recoverable amount is the higher of an asset's or cash-generating units (CGU) net selling price and its value in use. The recoverable amount is determined for an individual asset, unless the asset does not generate cash inflows that are largely independent of those from other assets or company's of assets. Where the carrying amount of an asset or CGU exceeds its recoverable amount, the asset is considered impaired and is written down to its recoverable amount.

In assessing value in use, the estimated future cash flows are discounted to their present value using a pre-tax discount rate that reflects current market assessments of the time value of money and the risks specific to the asset. In determining net selling price, recent market transactions are taken into account, if available. If no such transactions can be identified, an appropriate valuation model is used.

After impairment, depreciation is provided on the revised carrying amount of the asset over its remaining useful life.

xiii) Financial Instruments

A financial instrument is any contract that gives rise to a financial asset of one entity and a financial liability or equity instrument of another entity.

Financial assets

Initial recognition and measurement

Financial assets are classified, at initial recognition, as subsequently measured at amortised cost, fair value through other comprehensive income (OCI), and fair value through profit or loss.

The classification of financial assets at initial recognition depends on the financial asset's contractual cash flow characteristics and the company's business model for managing them. With the exception of trade receivables that do not contain a significant financing component or for which the company has applied the practical expedient, the company initially measures a financial asset at its fair value plus, in the case of a financial asset not at fair value through profit or loss, transaction costs. Trade receivables that do not contain a significant financing component or for which the company has applied the practical expedient are measured at the transaction price determined under Ind AS 115.

In order for a financial asset to be classified and measured at amortised cost or fair value through OCI, it needs to give rise to cash flows that are 'solely payments of principal and interest (SPPI)' on the principal amount outstanding. This assessment is referred to as the SPPI test and is performed at an instrument level. Financial assets with cash flows that are not SPPI are classified and measured at fair value through profit or loss, irrespective of the business model.

The company's business model for managing financial assets refers to how it manages its financial assets in order to generate cash flows. The business model determines whether cash flows will result from collecting contractual cash flows, selling the financial assets, or both. Financial assets classified and measured at amortised cost are held within a business model with the objective to hold financial assets in order to collect contractual cash flows while financial assets classified and measured at fair value through OCI are held within a business model with the objective of both holding to collect contractual cash flows and selling.

Purchases or sales of financial assets that require delivery of assets within a time frame established by regulation or convention in the market place (regular way trades) are recognised on the trade date, i.e., the date that the company commits to purchase or sell the asset.

Subsequent measurement

For purposes of subsequent measurement, financial assets are classified in four categories:

- ▶ Financial assets at amortised cost (debt instruments)
- ▶ Financial assets at fair value through other comprehensive income (FVTOCI) with recycling of cumulative gains and losses (debt instruments)
- ▶ Financial assets designated at fair value through OCI with no recycling of cumulative gains and losses upon derecognition (equity instruments)
- ▶ Financial assets at fair value through profit or loss

Financial assets at amortised cost (debt instruments)

A 'financial asset' is measured at the amortised cost if both the following conditions are met:

a) The asset is held within a business model whose objective is to hold assets for collecting contractual cash flows, and

b) Contractual terms of the asset give rise on specified dates to cash flows that are solely payments of principal and interest (SPPI) on the principal amount outstanding.

This category is the most relevant to the company. After initial measurement, such financial assets are subsequently measured at amortised cost using the effective interest rate (EIR) method. Amortised cost is calculated by taking into account any discount or premium on acquisition and fees or costs that are an integral part of the EIR. The EIR amortisation is included in finance income in the profit or loss.



#### Financial assets at fair value through OCI (FVTOCI) (debt instruments)

A 'financial asset' is classified as at the FVTOCI if both of the following criteria are met:

- a) The objective of the business model is achieved both by collecting contractual cash flows and selling the financial assets, and
- b) The asset's contractual cash flows represent SPPI.

Debt instruments included within the FVTOCI category are measured initially as well as at each reporting date at fair value. For debt instruments, at fair value through OCI, interest income, foreign exchange revaluation and impairment losses or reversals are recognised in the profit or loss and computed in the same manner as for financial assets measured at amortised cost. The remaining fair value changes are recognised in OCI. Upon derecognition, the cumulative fair value changes recognised in OCI is reclassified from the equity to profit or loss.

#### Financial assets designated at fair value through OCI (equity instruments)

Upon initial recognition, the company can elect to classify irrevocably its equity investments as equity instruments designated at fair value through OCI when they meet the definition of equity under Ind AS 32 Financial Instruments: Presentation and are not held for trading. The classification is determined on an instrument-by-instrument basis. Equity instruments which are held for trading and contingent consideration recognised by an acquirer in a business combination to which Ind AS103 applies are classified as at FVTPL.

Gains and losses on these financial assets are never recycled to profit or loss. Dividends are recognised as other income in the statement of profit and loss when the right of payment has been established, except when the company benefits from such proceeds as a recovery of part of the cost of the financial asset, in which case, such gains are recorded in OCI. Equity instruments designated at fair value through OCI are not subject to impairment assessment.

#### Financial assets at fair value through profit or loss

Financial assets at fair value through profit or loss are carried in the balance sheet at fair value with net changes in fair value recognised in the statement of profit and loss. This category includes derivative instruments and listed equity investments which the company had not irrevocably elected to classify at fair value through OCI. Dividends on listed equity investments are recognised in the statement of profit and loss when the right of payment has been established.

#### Derecognition

A financial asset (or, where applicable, a part of a financial asset or part of a company of similar financial assets) is primarily derecognised (i.e. removed from the company's balance sheet) when:

- ▶ The rights to receive cash flows from the asset have expired, or
- ▶ The company has transferred its rights to receive cash flows from the asset or has assumed an obligation to pay the received cash flows in full without material delay to a third party under a 'pass-through' arrangement; and either (a) the company has transferred substantially all of the risks and rewards of the asset, or (b) the company has neither transferred nor retained substantially all of the risks and rewards of the asset, but has transferred control of the asset.

When the company has transferred its rights to receive cash flows from an asset or has entered into a pass-through arrangement, it evaluates if and to what extent it has retained the risks and rewards of ownership. When it has neither transferred nor retained substantially all of the risks and rewards of the asset, nor transferred control of the asset, the company continues to recognise the transferred asset to the extent of the company's continuing involvement. In that case, the company also recognises an associated liability. The transferred asset and the associated liability are measured on a basis that reflects the rights and obligations that the company has retained.

Continuing involvement that takes the form of a guarantee over the transferred asset is measured at the lower of the original carrying amount of the asset and the maximum amount of consideration that the company could be required to repay.

#### Financial liabilities

##### Initial recognition and measurement

Financial liabilities are classified, at initial recognition, as financial liabilities at fair value through profit or loss, loans and borrowings, payables, or as derivatives designated as hedging instruments in an effective hedge, as appropriate.

All financial liabilities are recognised initially at fair value and, in the case of loans and borrowings and payables, net of directly attributable transaction costs.

The company's financial liabilities include trade and other payables, loans and borrowings including bank overdrafts, employee dues and interest accrued on borrowings, other interest payable.

##### Subsequent measurement

For purposes of subsequent measurement, financial liabilities are classified in two categories:

- Financial liabilities at fair value through profit or loss
- Financial liabilities at amortised cost (loans and borrowings)

#### Financial liabilities at fair value through profit or loss

Financial liabilities at fair value through profit or loss include financial liabilities held for trading and financial liabilities designated upon initial recognition as at fair value through profit or loss.

Financial liabilities are classified as held for trading if they are incurred for the purpose of repurchasing in the near term.

Financial liabilities designated upon initial recognition at fair value through profit or loss are designated as such at the initial date of recognition, and only if the criteria in Ind AS 109 are satisfied. For liabilities designated as FVTPL, fair value gains/ losses attributable to changes in own credit risk are recognized in OCI. These gains/ losses are not subsequently transferred to P&L.

#### Financial liabilities at amortised cost (Loans and borrowings)

This is the category most relevant to the Company. After initial recognition, interest-bearing loans and borrowings are subsequently measured at amortised cost using the EIR method. Gains and losses are recognised in profit or loss when the liabilities are derecognised as well as through the EIR amortisation process.

Amortised cost is calculated by taking into account any discount or premium on acquisition and fees or costs that are an integral part of the EIR. The EIR amortisation is included as finance costs in the statement of profit and loss.

This category generally applies to borrowings. For more information refer Note 12. Moreover, as assessed by management that the transaction costs incurred on long term term loans are insignificant to the value of loans and prepayment penalty does not exist.

#### Derecognition

A financial liability is derecognised when the obligation under the liability is discharged or cancelled or expires. When an existing financial liability is replaced by another from the same lender on substantially different terms, or the terms of an existing liability are substantially modified, such an exchange or modification is treated as the derecognition of the original liability and the recognition of a new liability. The difference in the respective carrying amounts is recognised in the statement of profit and loss.

#### Offsetting of financial instruments

Financial assets and financial liabilities are offset and the net amount is reported in the balance sheet if there is a currently enforceable legal right to offset the recognised amounts and there is an intention to settle on a net basis, to realise the assets and settle the liabilities simultaneously.

#### xiv) Compound Financial Instruments

Compound financial instruments issued by the company comprises of non convertible redeemable preference shares containing a zero percent dividend redeemable at par at the end of 10 years from the date of allotment and optionally convertible redeemable preference shares containing a zero percent dividend redeemable at par. The liability component of compound financial instrument is initially recognised at fair value. The equity portion is initially recognised as a difference between the fair value of the compound financial instrument as a whole and the fair value of the liability component. Any directly attributable transaction costs are allocated to the liability and equity components in the proportion of their initial carrying amounts.

Subsequent to initial recognition, the liability component of the compound financial instrument is measured at amortised costs using effective interest method. The equity component is not re-measured subsequently. Interest related to the financial liability is recognised in profit and loss (unless it qualifies for inclusion in the cost of an asset).

#### xv) Revenue from contract with customer

Revenue from contract with customer is recognised when control of the goods or services are transferred to the customer at an amount that reflects the consideration to which the Company expects to be entitled in exchange for those goods or services. Revenue is measured at the fair value of the consideration received or receivable, taking into account contractually defined terms of payment and excluding taxes or duties collected on behalf of the government.

#### Sale of goods -

Revenue from sale of goods is recognised at the point in time when control of the goods is transferred to the customer, generally on dispatch/ delivery of the goods or terms as agreed with the customer. The company considers whether there are other promises in the contract that are separate performance obligations to which a portion of the transaction price needs to be allocated. In determining the transaction price for the sale of goods, the company considers the effects of variable consideration, the existence of significant financing components, non-cash consideration, and consideration payable to the customer (if any).

#### Variable consideration -

If the consideration in a contract includes a variable amount, the Company estimates the amount of consideration to which it will be entitled in exchange for transferring the goods to the customer. The variable consideration is estimated at the time of completion of performance obligation and constrained until it is highly probable that a significant revenue reversal in the amount of cumulative revenue recognised will not occur when the associated uncertainty with the variable consideration is subsequently resolved.

#### Contract assets -

A contract asset is the right to consideration in exchange for goods transferred to the customer. If the Company performs its obligation by transferring goods to a customer before the customer pays consideration or before payment is due, a contract asset is recognised for the earned consideration that is conditional.

(a) Trade receivables: A receivable represents the Company's right to an amount of consideration that is unconditional (i.e., only the passage of time is required before payment of the consideration is due). Refer to accounting policies of financial assets i.e. Financial instruments – initial recognition and subsequent measurement.

#### Contract liabilities -

A contract liability is recognised if a payment is received or a payment is due (whichever is earlier) from a customer before the Company transfers the related goods or services. Contract liabilities are recognised as revenue when the Company performs under the contract (i.e., transfers control of the related goods or services to the customer).

#### Export incentives

Export incentives under various schemes notified by government are accounted for in the year of exports based on eligibility and when there is no uncertainty in receiving the same and is included in revenue in the statement of profit and loss due to its operating nature.

#### Windmill energy income

Consideration for electricity generated by the windmill division and fed into the state power grid is received in the form of credit in the manufacturing division's power bill. Credits are recognised as income net of wheeling charges. Income so recognised is shown separately from the power cost under Other operating revenue

#### Interest Income

Interest income from financial assets is recognised when it is probable that the economic benefit will flow to the Company and the amount of income can be measured reliably. Interest income is recorded using the effective interest rate (EIR). Interest income is accrued on a time basis, by reference to the principal outstanding and the interest rate applicable, which is the rate that exactly discounts estimated future cash receipts through the expected life of the financial asset to that asset's net carrying amount on initial recognition.

#### Rental Income

Rental income arising from operating leases is accounted on the basis of lease terms and is included in other income in the statement of profit and loss.

#### xvi) Employee benefits

##### Defined Contribution Plan-

The company's contribution to provident fund is considered as a defined contribution scheme and are charged as expense based on the amount of contribution required to be made and when the services are rendered by the employees.

##### Defined Benefit Plan -

The company operates a defined benefit plan for its employees, viz., gratuity liability. The costs of providing benefits under this plan are determined on the basis of actuarial valuation at each year-end. Actuarial valuation is carried out for the plan using the projected unit credit method. Remeasurements comprising of actuarial gains and losses, the effect of changes to the return on plan assets (excluding net interest) is reflected immediately in the balance sheet with a charge or credit recognised in OCI in the period in which they occur.

Remeasurements recognised in OCI are reflected immediately in retained earnings and is not reclassified to in the statement of profit and loss. Net interest is calculated by applying the discount rate to the net defined benefit liability or asset.

##### Long-term employee benefits:

Compensated absences which are not expected to occur within twelve months after the end of the period in which the employee renders the related service are recognised as a liability at the present value of the estimated future cash outflows expected to be made by the Company in respect of services provided by employees up to the balance sheet date.

##### Short term employee benefits -

Accumulated leave, which is expected to be utilized within the next 12 months, is treated as short-term employee benefit. The company measures the expected cost of such absences as the additional amount that it expects to pay as a result of the unused entitlement that has accumulated at the reporting date.

#### xvii) Foreign currencies

The company's financial statements are presented in INR, which is also company's functional currency.

##### 'Initial recognition -

'Foreign currency transactions are recorded in the reporting currency, by applying to the foreign currency amount the exchange rate between the reporting currency and the foreign currency at the date of the transaction.

##### Measurement of foreign currency monetary items at the Balance Sheet date -

'Foreign currency monetary items are retranslated using the exchange rate prevailing at the reporting date. Non-monetary items, which are measured in terms of historical cost denominated in a foreign currency, are reported using the exchange rate at the date of the transaction.

##### Treatment of exchange differences -

'Exchange differences arising on the settlement of monetary items or on reporting monetary items of company at rates different from those at which they were initially recorded during the year, or reported in previous financial statements, are recognised as income or as expenses in the year in which they arise .

#### xviii) Borrowing costs

Borrowing costs directly attributable to the acquisition, construction or production of an asset that necessarily takes a substantial period of time to get ready for its intended use or sale are capitalised as part of the cost of the asset. All other borrowing costs are expensed in the period in which they occur. Borrowing costs consist of interest and other costs that an entity incurs in connection with the borrowing of funds. Borrowing cost also includes exchange differences to the extent regarded as an adjustment to the borrowing costs.

#### xix) Income taxes

Tax expense comprises current and deferred tax.

##### Current tax -

The tax currently payable is based on the taxable profits for the years. Current income-tax is measured at the amount expected to be paid to the tax authorities in accordance with the Income-tax Act, 1961 enacted in India.

Management periodically evaluates positions taken in the tax returns with respect to situations in which applicable tax regulations are subject to interpretation and considers whether it is probable that a taxation authority will accept an uncertain tax treatment. The Company shall reflect the effect of uncertainty for each uncertain tax treatment by using either most likely method or expected value method, depending on which method predicts better resolution of the treatment.

The tax rates and tax laws used to compute the amount are those that are enacted or substantively enacted, at the reporting date.

##### Deferred tax-

'Deferred tax is recognised on temporary differences between the carrying amounts of assets and liabilities in the financial statements and the corresponding tax base used in the computation of taxable profit. Deferred tax liabilities are generally recognised for all taxable temporary differences.

Deferred tax assets are generally recognised for all deductible temporary differences to the extent that it is probable that taxable profits will be available against which those deductible temporary differences can be utilised. Such deferred tax assets and liabilities are not recognised if the temporary difference arises from the initial recognition of assets and liabilities in a transaction that affects neither the taxable profit nor the accounting profit.

The carrying amount of deferred tax assets is reviewed at the end of each reporting period and reduced to the extent that it is no longer probable that sufficient taxable profits will be available to allow all or part of the asset to be recovered.

Deferred tax liabilities and assets are measured at the tax rates that are expected to apply in the period in which the liability is settled or the asset realised, based on tax rates (and tax laws) that have been enacted or substantively enacted by the end of the reporting period.

The measurement of deferred tax liabilities and assets reflects the tax consequences that would follow from the manner in which the Company expects, at the end of the reporting period, to recover or settle the carrying amount of its assets and liabilities.

Deferred tax assets include Minimum Alternate Tax (MAT) credit paid in accordance with the tax laws in India, which is likely to give future economic benefits in the form of availability of set off against future income tax liability. Accordingly, MAT credit is recognised as deferred tax asset in the Balance sheet when the asset can be measured reliably and it is probable that the future economic benefit associated with the asset will be realised.

xx) Provisions and contingent liabilities

Provisions are recognised when the company has a present obligation (legal or constructive) as a result of a past event, it is probable that an outflow of resources embodying economic benefits will be required to settle the obligation and a reliable estimate can be made of the amount of the obligation. When the company expects some or all of a provision to be reimbursed, for example, under an insurance contract, the reimbursement is recognised as a separate asset, but only when the reimbursement is virtually certain. The expense relating to a provision is presented in the statement of profit and loss net of any reimbursement.

If the effect of the time value of money is material, provisions are discounted using a current pre-tax rate that reflects, when appropriate, the risks specific to the liability. When discounting is used, the increase in the provision due to the passage of time is recognised as a finance cost.

When some or all of the economic benefits required to settle a provision are expected to be recovered from a third party, a receivable is recognised as an asset if it is virtually certain that reimbursement will be received and the amount of the receivable can be measured reliably.

Contingent liabilities and Contingent assets are not recognised in the financial statements when an inflow/ outflow of economic benefits/ loss is not probable.

xxi) Operating Segments

Basis of Segmentation-

The company is mainly engaged in the business of manufacturing and selling of machined / forged rings and auto components. The company's business falls within a single business segment of 'diversified auto components' and all the activities of the Company revolve around this main business.

The Chief Operating decision maker (CODM) monitors the operating results of the business as a whole for the purpose of making decisions about resource allocation and performance assessment.

Therefore, management views company's business activity as a single segment and segment's performance is evaluated based on profit or loss and is measured consistently with profit or loss in the financial statements.

Geographical Information -

The management evaluates that the company operates in two principal geographical areas - India and Outside India.

Company's Revenue and Receivables are specified by location of customers and the other geographic information (Segment Assets and Capital Expenditure) are specified by location of the assets.

xxii) Earnings per share

Basic earnings per share are calculated by dividing the net profit or loss for the period attributable to equity shareholders by the weighted average number of equity shares outstanding during the period.

For the purpose of calculating diluted earnings per share, the net profit or loss for the period attributable to equity shareholders and the weighted average number of shares outstanding during the period are adjusted for the effects of all dilutive potential equity shares. Potential equity shares are deemed to be dilutive only if their conversion to equity shares would decrease the net profit per share from continuing ordinary operations. Potential dilutive equity shares are deemed to be converted as at the beginning of the period, unless they have been issued at a later date. The dilutive potential equity shares are adjusted for the proceeds receivable had the shares been actually issued at fair value (i.e. average market value of the outstanding shares). Dilutive potential equity shares are determined independently for each year presented.

xxiii) Fair Value Measurement

The Company measures certain financial instruments at fair value at each balance sheet date. Fair value is the price that would be received to sell an asset or paid to transfer a liability in an orderly transaction between market participants at the measurement date. The fair value measurement is based on the presumption that the transaction to sell the asset or transfer the liability takes place either:

- the principal market for the asset or liability, or
- In the absence of a principal market, in the most advantageous market for the asset or liability

The principal or the most advantageous market must be accessible by the Company. The fair value of an asset or a liability is measured using the assumptions that market participants would use when pricing the asset or liability, assuming that market participants act in their economic best interest. A fair value measurement of a non-financial asset takes into account a market participant's ability to generate economic benefits by using the asset in its highest and best use or by selling it to another market participants that would use the asset in its highest and best use.

The Company uses valuation techniques that are appropriate in the circumstances and for which sufficient data are available to measure fair value, maximising the use of relevant observable inputs and minimising the use of unobservable inputs. All assets and liabilities for which fair value is measured or disclosed in the financial statements are categorised within the fair value hierarchy, described as under, based on the lowest level input that is significant to the fair value measurement as a whole:

- Level 1 - Quoted (unadjusted) market prices in active markets for identical assets or liabilities.
- Level 2 - Valuation techniques for which the lowest level input that is significant to the fair value measurement is directly or indirectly observable
- Level 3 - Valuation techniques for which the lowest level input that is significant to the fair value measurement is unobservable

For assets and liabilities that are recognised in the financial statements on a recurring basis, the Company determines whether transfers have occurred between levels in the hierarchy by re-assessing categorisation (based on the lowest level input that is significant to the fair value measurement as a whole) at the end of each reporting period.

The Company's management determines the policies and procedures for both recurring fair value measurement, such as unquoted financial assets measured at fair value, and for non-recurring measurement, such as assets held for distribution in discontinued operations. The management comprises of the Managing Director and Chief Finance Officer (CFO).

External valuers are involved for valuation of significant assets. Involvement of external valuers is decided upon annually by the board of directors after discussion with and approval by the management. Selection criteria include market knowledge, reputation, independence and whether professional standards are maintained. Valuers are normally rotated every three years. The management decides, after discussions with the Company's external valuers, which valuation techniques and inputs to use for each case. At each reporting date, the management analyses the movements in the values of assets and liabilities which are required to be re-measured or re-assessed as per the Company's accounting policies. For this analysis, the management verifies the major inputs applied in the latest valuation by agreeing the information in the valuation computation to contracts and other relevant documents.

The management, in conjunction with the Company's external valuers, also compares the change in the fair value of each asset and liability with relevant external sources to determine whether the change is reasonable. For the purpose of fair value disclosures, the Company has determined classes of assets and liabilities on the basis of the nature, characteristics and risks of the asset or liability and the level of the fair value hierarchy as explained above.

Annexure VI

Part A: Statement of Restatement Adjustments to Audited Financial Statements

Reconciliation between audited profit and restated profit

Sr. No.	Particulars	Note No.	Year ended March 31, 2021	Year ended March 31, 2020	Year ended March 31, 2019 (Proforma)
A	Profit after tax (as per audited financial statements)		869.55	533.31	616.54
B	Adjustment for conversion from IGAAP to Ind AS/ Proforma Ind AS	1	-	(3.90)	(26.13)
C	Restatement Adjustments		-	-	-
D	Restated profit after tax (A+B+C)		869.55	529.41	590.41

Reconciliation between total audited equity and total restated equity

Sr. No.	Particulars	Note No.	As at March, 2021	As at March 31, 2020	As at March 31, 2019 (Proforma)	As at April 01, 2018 (Proforma)
A.	Total Equity as per audited financial statements		3,567.33	2,788.69	2,255.38	1,638.84
B.	Adjustment for conversion from IGAAP to Ind AS/ Proforma Ind AS	1	-	(107.64)	(101.94)	(75.58)
C.	Material Restatement Adjustments		-	-	-	-
D.	Total Equity as Restated Ind AS Summary Statement of Assets and Liabilities (A+B+C)		3,567.33	2,681.05	2,153.44	1,563.26

Note:

1. Adjustment for conversion from IGAAP to Ind AS

The audited financial statements of the Company as at and for the year ended March 31, 2020 and March 31, 2019(Proforma) were prepared in accordance with accounting principles generally accepted in India including the Companies Accounting Standards Rules, 2006 (as amended) specified under Section 133 of the Act read with Companies (Accounts) Rules, 2014 (as amended). The same have been converted into Ind AS to conform with the accounting policies generally accepted in India including Indian Accounting Standards ("Ind AS") specified under section 133 of the Act, read with the Companies (Indian Accounting Standards) Rules, 2015, as amended. For further details, refer Annexure VII Note 38 for Ind AS adjustments of total comprehensive income for year ended March 31, 2020 and March 31, 2019 (Proforma) and for Equity as at March 31, 2020, March 31, 2019 (Proforma) and April 01, 2018 (Proforma).

Part B: Material Regrouping

Appropriate regroupings have been made in the Restated Ind AS Summary Statement of Assets and Liabilities, Restated Ind AS Summary Statement of Profit and Loss and Restated Ind AS Summary Statement of Cash Flows, wherever required, by reclassification of the corresponding items of income, expenses, assets, liabilities and cash flows, in order to bring them in line with the accounting policies and classification as per Ind AS financial information of the Company for the year ended March 31,2021 prepared in accordance with Schedule III of Companies Act, 2013, requirements of Ind AS 1 and other applicable Ind AS principles and the requirements of the Securities and Exchange Board of India (Issue of Capital & Disclosure Requirements) Regulations 2018, as amended.

Rolex Rings Limited (formerly known as Rolex Rings Private Limited)  
 CIN: U28910GJ2003PLC041991  
 (All amount in Indian rupees million, unless otherwise stated)

Annexure VI  
 Part C: Non Adjusting items

Restated Ind AS Summary Statements does not contain any qualifications requiring adjustments. Qualifications in the Companies (Auditor's Report) Order, 2016 issued by the Central Government of India in terms of sub section (11) of section 143 of the Act, which do not require any corrective adjustments in the Restated Ind AS Summary Statements are as follows:

As at and for the year ended March 31, 2021

Annexure to Auditor's report for the financial year ended March 31, 2021

Clause (i) (a)

The Company has maintained proper records showing full particulars, including quantitative details and situation of Property, Plant & Equipment, except in case of certain assets where the company is in process of updating the quantitative and other details.

Clause (vii) (a)

Undisputed statutory dues including provident fund, employees' state insurance, Income-tax, duty of custom, goods and service tax, cess and other material statutory dues have generally been regularly deposited with the appropriate authorities though there has been a slight delay in a few cases.

Clause (vii) (c)

According to the records of the Company, the dues outstanding of income tax, sales-tax service tax, duty of custom, duty of excise, value added tax and cess on account of any dispute are as follows:

Nature of the Statute	Nature of the Dues	Amount (INR in Millions) *	Period to which the amount pertains	Forum where dispute is pending
The Custom Tariff Act, 1975	DEPB Duty Credit	105.58	2015-16	Gujarat High Court
The Central Excise Tariff Act 1985	Duty Drawback	10.61	2013-14	Gujarat High Court
The Gujarat Sales Tax, Act 1969	Value added Tax and Central Sales Tax	0.25	2013-14	Commissioner of Appeals
The Finance Act, 1992	Service Tax	7.98	2011 to 2013, 2016 to 2018	Commissioner Appeals - Central GST & Excise
The Finance Act, 1992	Service Tax	0.93	2011 to 2016, 2017-18	Appellate Tribunal of Customs, Excise & Service Tax
The Finance Act, 1992	Service Tax	1.75	2017-18	Assessing Officer
The Goods and Service Tax Act, 2017	Goods and Service Tax	1.11	2017-18	Assessing Officer
The Income Tax Act, 1961	Income Tax	132.08	2004-05, 2008 -09, 2011-12 to 2014-15	Commissioner of Income Tax Appeals

\* Above amounts are net of amount paid under protest of INR 12.60 million for Income tax and INR 1.30 million for indirect taxes.

As at and for the year ended March 31, 2020

Annexure to Auditor's report for the financial year ended March 31, 2020

Clause (i) (a)

The Company has maintained proper records showing full particulars, including quantitative details and situation of Property, Plant & Equipment, except in case of certain old assets where the company is in process of updating the quantitative and other details.

Clause (vii) (a)

Undisputed statutory dues including provident fund, employees' state insurance, Income-tax, duty of custom, goods and service tax, cess and other material statutory dues have generally been regularly deposited with the appropriate authorities though there has been a slight delay in a few cases.

Rolex Rings Limited (formerly known as Rolex Rings Private Limited)  
CIN: U28910GJ2003PLC041991  
(All amount in Indian rupees million, unless otherwise stated)

Annexure VI  
Part C: Non Adjusting items

Clause (vii) (c)

According to the records of the Company, the dues outstanding of income tax, sales-tax service tax, duty of custom, duty of excise, value added tax and cess on account of any dispute are as follows:

Nature of the Statute	Nature of the Dues	Amount (INR in Millions) *	Period to which the amount pertains	Forum where dispute is pending
The Custom Tariff Act, 1975	DEPB Duty Credit	105.58	2015-16	Gujarat High Court
The Central Excise Tariff Act 1985	Duty Drawback	10.61	2011-12, 2013-14	Gujarat High Court
The Gujarat Sales Tax, Act 1969	Value added Tax and Central Sales Tax	0.25	2013-14	Commissioner of Appeals
The Finance Act, 1992	Service Tax	9.48	2011 to 2016, 2018 to 2020	Commissioner of Central Excise – Appeals
The Finance Act, 1992	Service Tax	5.65	2011 to 2016, 2017-18	Appellate Tribunal of Customs, Excise & Service Tax
The Central Excise Act 1944	Excise duty -Rebate	0.45	2014-15	Commissioner of Central Excise – Appeals
The Income Tax Act ,1961	Income Tax	97.35	2004-2005, 2012-13, 2013-14 & 2014-15	Commissioner of Income Tax Appeals

\* Above amounts are net of amount paid under protest of INR 12.60 million for Income tax and INR 1.30 million for indirect taxes.

As at and for the year ended March 31, 2019  
Annexure to Auditor's report for the financial year ended March 31, 2019

Clause (i) (a)

The Company has maintained proper records showing full particulars, including quantitative details and situation of Property, Plant & Equipment, except in case of certain old assets where the company is in process of updating the quantitative and other details.

Clause (vii) (a)

Undisputed statutory dues including provident fund, employees' state insurance, Income-tax, duty of custom, goods and service tax, cess and other material statutory dues have generally been regularly deposited with the appropriate authorities though there has been a slight delay in a few cases.



Rolex Rings Limited (formerly known as Rolex Rings Private Limited)  
CIN: U28910GJ2003PLC041991  
(All amount in Indian rupees million, unless otherwise stated)

Annexure VI  
Part C: Non Adjusting items

Clause (vii) (c)

According to the records of the Company, the dues outstanding of income tax, sales-tax service tax, duty of custom, duty of excise, value added tax, goods and service tax and cess on account of any dispute are as follows:

Nature of the Statute	Nature of the Dues	Amount (INR in Millions) *	Period to which the amount relates	Forum where dispute is pending
The Custom Tariff Act, 1975	DEPB Duty Credit	106.53	2015-16	Gujarat High Court
The Central Excise Tariff Act 1985	Duty Drawback	10.61	2011-12/ 2013-14	Gujarat High Court
The Central Excise Act 1944	Excise duty	0.45	2014-15	Commissioner of Central Excise – Appeals
The Gujarat (Sales Tax) Act 1969	Value added Tax and Central Sales Tax	5.05	2004-05	Gujarat VAT Tribunal
The Gujarat (Sales Tax) Act 1969	Value added Tax and Central Sales Tax	1.05	2009-10	Dy. Commissioner of GVAT - Appeals
The Gujarat (Sales Tax) Act 1969	Value added Tax and Central Sales Tax	4.33	2012-13	Dy. Commissioner of VAT - Appeals
The Gujarat Sales Tax, Act 1969	Value added Tax and Central Sales Tax	0.25	2013-14	Commissioner of Appeals
The Finance Act, 1992	Service Tax	16.54	2011 to 2017	Commissioner of Central Excise – Appeals
The Finance Act, 1992	Service Tax	0.93	2017-2018	Central Excise and Service Tax appellate tribunal
The Income Tax Act ,1961	Income Tax	97.35	2014-15	Commissioner of Income Tax Appeals

\* Above amounts are net of amount paid under protest of INR 12.60 million for Income tax and INR 5.09 million for indirect taxes.

Clause (viii)

According to the information and explanations given by the management, the Company has delayed in repayment of loans to financial institutions and banks during the year to the extent of Rs. 373.74 million (the delay in such repayments being for less than 62 days in each individual case) and no such dues were in arrears as on the balance sheet date.

Annexure VII  
Notes to Restated Ind AS Summary Statements

3.1 Property, plant and equipment

Particulars	Land (Freehold)	Building	Plant and machinery	Furniture and fixture	Computers	Vehicles	Total	Capital Work in progress
<b>Deemed Cost</b>								
As at April 1, 2018 (Proforma)	208.83	542.24	2,769.59	39.90	7.02	14.28	3,581.86	396.13
Additions	0.24	23.04	682.08	0.90	3.47	0.02	709.75	318.51
Disposals/ transfers	-	-	(16.79)	-	-	-	(16.79)	(705.12)
At March 31, 2019 (Proforma)	209.07	565.28	3,434.88	40.80	10.49	14.30	4,274.82	9.52
Additions	34.52	4.59	147.36	0.65	0.79	-	187.91	142.43
Disposals/ transfers	-	-	(5.48)	-	-	(0.57)	(6.05)	(151.95)
At March 31, 2020	243.59	569.87	3,576.76	41.45	11.28	13.73	4,456.68	-
Additions	13.72	4.38	218.29	-	1.35	0.06	237.80	227.95
Disposals/ transfers	-	-	(4.04)	-	-	-	(4.04)	(216.43)
At March 31, 2021	257.31	574.25	3,791.01	41.45	12.63	13.79	4,690.44	11.52
<b>Depreciation</b>								
As at April 1, 2018 (Proforma)	-	31.71	189.29	5.58	3.21	0.69	230.48	-
Charge for the year	-	31.28	210.14	5.22	3.75	2.04	252.43	-
On Disposals/ transfers	-	-	(16.49)	-	-	-	(16.49)	-
At March 31, 2019 (Proforma)	-	62.99	382.94	10.80	6.96	2.73	466.42	-
Charge for the year	-	30.37	223.18	4.52	2.38	1.73	262.18	-
On Disposals/ transfers	-	-	(1.80)	-	-	(0.42)	(2.22)	-
At March 31, 2020	-	93.36	604.32	15.32	9.34	4.04	726.38	-
Charge for the year	-	28.80	215.87	3.92	1.55	1.45	251.59	-
On Disposals/ transfers	-	-	(1.46)	-	-	-	(1.46)	-
At March 31, 2021	-	122.16	818.73	19.24	10.89	5.49	976.51	-
<b>Net block</b>								
At March 31, 2019 (Proforma)	209.07	502.29	3,051.94	30.00	3.53	11.57	3,808.40	9.52
At March 31, 2020	243.59	476.51	2,972.44	26.13	1.94	9.69	3,730.30	-
At March 31, 2021	257.31	452.09	2,972.28	22.21	1.74	8.30	3,713.93	11.52

Capital work in progress (CWIP) consists of construction of buildings and plant and machinery at manufacturing units.

Rolex Rings Limited (formerly known as Rolex Rings Private Limited)  
CIN: U28910GJ2003PLC041991  
(All amount in Indian rupees million, unless otherwise stated)

Annexure VII  
Notes to Restated Ind AS Summary Statements

3.2 Right of use assets

Particulars	Windmill	Total
Deemed Cost		
As at April 1, 2018 (Proforma)	1.08	1.08
Additions	-	-
At March 31, 2019 (Proforma)	1.08	1.08
Additions	-	-
At March 31, 2020	1.08	1.08
Additions	-	-
At March 31, 2021	1.08	1.08
Depreciation		
As at April 1, 2018 (Proforma)	0.10	0.10
Charge for the year	0.16	0.16
At March 31, 2019 (Proforma)	0.26	0.26
Charge for the year	0.16	0.16
At March 31, 2020	0.42	0.42
Charge for the year	0.16	0.16
At March 31, 2021	0.58	0.58
Net block		
At March 31, 2019 (Proforma)	0.82	0.82
At March 31, 2020	0.66	0.66
At March 31, 2021	0.50	0.50

Rolex Rings Limited (formerly known as Rolex Rings Private Limited)  
CIN: U28910GJ2003PLC041991  
(All amount in Indian rupees million, unless otherwise stated)

Annexure VII  
Notes to Restated Ind AS Summary Statements

3.3 Intangible assets

Particulars	Other intangibles - Computer software	Total intangible assets
<b>Deemed Cost</b>		
As at April 1, 2018 (Proforma)	7.92	7.92
Additions	9.46	9.46
At March 31, 2019 (Proforma)	17.38	17.38
Additions	0.46	0.46
At March 31, 2020	17.84	17.84
Additions	0.12	0.12
At March 31, 2021	17.96	17.96
<b>Amortisation</b>		
As at April 1, 2018 (Proforma)	1.43	1.43
Charge for the year	1.81	1.81
At March 31, 2019 (Proforma)	3.24	3.24
Charge for the year	2.90	2.90
At March 31, 2020	6.14	6.14
Charge for the year	2.34	2.34
At March 31, 2021	8.48	8.48
<b>Net block</b>		
At March 31, 2019 (Proforma)	14.14	14.14
At March 31, 2020	11.70	11.70
At March 31, 2021	9.48	9.48

Annexure VII

Notes to Restated Ind AS Summary Statements

4 Loans

(Unsecured, considered good unless otherwise stated)

	As at March 31, 2021	As at March 31, 2020	As at March 31, 2019 (Proforma)
Non-current			
At amortised cost			
Loans to Directors (Refer Note 28)	-	25.00	33.30
Total non-current loans	-	25.00	33.30
Current			
At amortised cost			
Loans and Advances to Employees	0.76	0.97	1.23
Loans to Others	-	29.90	-
Total current loans	0.76	30.87	1.23
Sub-classification of above			
Loans receivable considered good - Secured	-	-	-
Loans receivable considered good - Unsecured	0.76	55.87	34.53
Loans receivables which have significant increase in credit risk	-	-	-
Loans receivables - credit impaired	-	-	-
Less: Provision for impairment	-	-	-
	0.76	55.87	34.53

Disclosure required under section 186(4) of the Companies Act, 2013:

Particulars	Rate of Interest	As at March 31, 2021	As at March 31, 2020	As at March 31, 2019 (Proforma)
Loan given to directors (Note 4 and 28)	11%	-	25.00	25.00
Loan given to M/s. Fillenpac Industries Pvt Ltd	11%	-	-	8.30
Loan given to Aryan Arcade	10%	-	29.90	-

No loans and advances are due from directors or other officers of the Company, firms in which a director is a partner or private companies in which director is a director or a member either severally or jointly with any other person other than as disclosed in Note 28.

Annexure VII  
Notes to Restated Ind AS Summary Statements

5 Other financial assets

	As at March 31, 2021	As at March 31, 2020	As at March 31, 2019 (Proforma)
<b>Non-Current</b>			
Deposits with remaining maturity of more than twelve months*	118.96	15.90	106.94
Security Deposits	4.57	5.17	5.43
Interest accrued on fixed deposits	3.47	-	-
Other Receivable	12.63	12.63	12.63
<b>Total other non-current financial assets</b>	<b>139.63</b>	<b>33.70</b>	<b>125.00</b>
<b>Current</b>			
Export Incentive Receivable	60.98	58.30	92.29
Interest accrued on fixed deposits	3.79	-	6.31
Interest accrued on loans**	3.19	1.69	3.40
<b>Total other current financial assets</b>	<b>67.96</b>	<b>59.99</b>	<b>102.00</b>

\*Note: Consists pledged lien against bank guarantees, letter of credit and other credit facilities as margin money deposits

\*\* For balance pertaining to related parties - Refer Note -28

6 Inventories

(valued at lower of cost and net realisable value)

	As at March 31, 2021	As at March 31, 2020	As at March 31, 2019 (Proforma)
Raw materials	485.37	393.71	521.69
Work-in-progress	400.68	276.33	330.74
Finished goods#	720.43	553.18	654.69
Stores and Spares	101.76	77.61	93.02
Scrap	2.49	4.88	1.87
<b>Total inventories</b>	<b>1,710.73</b>	<b>1,305.71</b>	<b>1,602.01</b>
<u>Goods in transit included in above:</u>			
# Finished goods	506.89	355.17	355.64
	<b>506.89</b>	<b>355.17</b>	<b>355.64</b>

Note : For the year ended March 31, 2021, March 31,2020 and March 31,2019, INR 18.63 millions, INR 7.23 millions and INR 33.54 millions respectively was recognised as an expense disclosed under cost of materials and components consumed for finished goods recognised at net realised value.

7 Trade Receivables

	As at March 31, 2021	As at March 31, 2020	As at March 31, 2019 (Proforma)
Unsecured, considered good	1,708.01	1,276.72	1,814.96
Trade receivables which have significant increase in credit risk	20.21	20.21	20.21
Trade receivables - credit impaired	-	-	-
	<b>1,728.22</b>	<b>1,296.93</b>	<b>1,835.17</b>
Impairment allowance			
Trade receivables which have significant increase in credit risk	(20.21)	(20.21)	(20.21)
	<b>(20.21)</b>	<b>(20.21)</b>	<b>(20.21)</b>
	<b>1,708.01</b>	<b>1,276.72</b>	<b>1,814.96</b>

No trade receivable are due from directors or other officers of the Company either severally or jointly with any other person. Nor any trade receivables due from firms or private companies respectively in which any director is a partner, a director or a member other than as disclosed in Note 28.

Trade receivables are non interest bearing and generally on terms of 30 to 90 days.

The following table summarises the change in impairment allowance measured using the life time expected credit loss model:

	As at March 31, 2021	As at March 31, 2020	As at March 31, 2019 (Proforma)
At the beginning of the year	20.21	20.21	16.88
Provision made during the year	-	-	3.33
Utilized /reversed during the year	-	-	-
<b>At the end of the year</b>	<b>20.21</b>	<b>20.21</b>	<b>20.21</b>

Annexure VII  
Notes to Restated Ind AS Summary Statements

8 Cash and bank balances

	As at March 31, 2021	As at March 31, 2020	As at March 31, 2019 (Proforma)
8.1 Cash and cash equivalents			
Balance with Banks			
- on current accounts	45.70	12.10	0.93
Cash on hand	0.42	0.35	0.45
Total cash and cash equivalents	46.12	12.45	1.38
8.2 Bank balances other than cash and cash equivalents*			
Other bank balances			
Deposits with original maturity of more than three months but remaining maturity of less than twelve months	58.05	151.91	45.25
Deposits with remaining maturity of more than twelve months	118.96	15.90	106.94
Less: Amount disclosed under other financial assets (refer note 5)	(118.96)	(15.90)	(106.94)
Total bank balances other than cash and cash equivalents	58.05	151.91	45.25
Total cash and bank balances	104.17	164.36	46.63

\*Note: Deposit consists of pledged lien against bank guarantees, letter of credit and other credit facilities

Changes in liabilities arising from financing activities:

Particulars	As at April 1, 2020	Cash changes (net)	Others*	As at March 31, 2021
Long term borrowings including current maturities classified in other financial liabilities	650.27	(15.44)	24.36	659.19
Short term borrowings	1,939.26	(97.25)	(6.29)	1,835.72
Non-current lease liabilities	0.94	-	(0.27)	0.67
Current lease liabilities	0.39	(0.39)	0.39	0.39

Particulars	As at April 1, 2019	Cash changes (net)	Others*	As at March 31, 2020
Long term borrowings including current maturities classified in other financial liabilities	1,508.43	(866.68)	8.52	650.27
Short term borrowings	2,343.25	(480.72)	76.73	1,939.26
Non-current lease liabilities	1.18	-	(0.24)	0.94
Current lease liabilities	0.39	(0.39)	0.39	0.39

Particulars	As at April 1, 2018	Cash changes (net)	Others*	As at March 31, 2019
Long term borrowings including current maturities classified in other financial liabilities	2,410.46	(909.72)	7.69	1,508.43
Short term borrowings	2,640.55	(257.68)	(39.62)	2,343.25
Non-current lease liabilities	1.40	-	(0.22)	1.18
Current lease liabilities	0.39	(0.39)	0.39	0.39

\*Others consists of exchange differences on amount borrowed and impact of unwinding of liability component of compound financial instruments.

9 Other assets  
(Unsecured, considered good unless otherwise stated)

	As at March 31, 2021	As at March 31, 2020	As at March 31, 2019 (Proforma)
Non-current			
Capital advances	271.19	94.25	111.75
Balances with statutory/government Authorities	17.04	17.04	19.66
Total other non-current assets	288.23	111.29	131.41
Current			
Advances to suppliers	98.41	32.43	56.50
Advance to related parties (Refer Note 28)	-	-	4.88
Accrued Windmill income	2.78	5.43	4.22
Prepaid expenses	15.22	12.21	13.90
Balance with statutory/ government authorities	78.25	41.86	33.99
Total other current assets	194.66	91.93	113.49

Annexure VII  
Notes to Restated Ind AS Summary Statements

10.1 Equity share capital

Particulars	Equity shares	
	No. of Shares	Amount
Authorised shares of Rs. 10 each		
As at April 01, 2018 (Proforma)	3,50,25,000	350.25
Increase during the year		
As at March 31, 2019 (Proforma)	3,50,25,000	350.25
Increase during the year	-	-
As at March 31, 2020	3,50,25,000	350.25
Increase during the year	-	-
As at March 31, 2021	3,50,25,000	350.25

Particulars	Equity shares	
	No. of Shares	Amount
Issued, subscribed and fully paid up equity shares of Rs. 10 each:		
As at April 01, 2018 (Proforma)	2,39,81,090	239.81
Add : Issue of shares	-	-
As at March 31, 2019 (Proforma)	2,39,81,090	239.81
Add : Issue of shares	-	-
As at March 31, 2020	2,39,81,090	239.81
Add : Issue of shares	-	-
As at March 31, 2021	2,39,81,090	239.81

Terms/ rights attached to equity shares

The company has only one class of equity shares having par value of Rs. 10 per share. Each holder of equity shares is entitled to one vote per share. The company declares and pays dividends in Indian rupees. The dividend proposed by the Board of Directors is subject to the approval of the shareholders in the ensuing Annual General Meeting.

In the event of liquidation of the company, the holders of equity shares will be entitled to receive remaining assets of the company, after distribution of all preferential amounts. The distribution will be in proportion to the number of equity shares held by the shareholders.

Details of shareholders more than 5% shares in the Company

Name of the shareholder	As at March 31, 2021		As at March 31, 2020		As at March 31, 2019 (Proforma)	
	Nos.	% holding	Nos.	% holding	Nos.	% holding
<u>Equity shares of Rs. 10 each fully paid</u>						
Rupesh D Madeka	20,90,667	8.72%	20,90,667	8.72%	20,90,667	8.72%
Jiten D Madeka	20,90,667	8.72%	20,90,667	8.72%	20,90,667	8.72%
Ashok D Madeka	7,16,667	2.99%	13,06,667	5.45%	13,06,667	5.45%
Manesh D Madeka	22,87,252	9.54%	20,90,667	8.72%	20,90,667	8.72%
Pinakin D Madeka	24,75,533	10.32%	22,21,333	9.26%	22,21,333	9.26%
Bhautik D Madeka	18,37,881	7.66%	14,37,333	5.99%	14,37,333	5.99%
Rivendell PE LLC	1,09,14,423	45.51%	1,09,14,423	45.51%	1,09,14,423	45.51%

As per records of the Company, including its register of shareholders / members and other declarations received from shareholders regarding beneficial interest, the above shareholding represents both legal and beneficial ownership of shares.

The Company has not issued/ allotted any shares pursuant to contracts without payment being received in cash, nor issued any bonus shares nor there has been any buy back of shares during five years immediately preceding March 31, 2021.



Annexure VII  
Notes to Restated Ind AS Summary Statements

10.2 Equity Component of Non Convertible Redeemable Preference Shares

	Non Convertible Redeemable Preference Shares	
	No. of Shares	Amount
	Rs. 10 each	
Authorised shares:		
As at April 1, 2018 (Proforma)	1,59,75,000	159.75
Increase during the year	-	-
As at March 31, 2019 (Proforma)	1,59,75,000	159.75
Increase during the year	-	-
As at March 31, 2020	1,59,75,000	159.75
Increase during the year	-	-
As at March 31, 2021	1,59,75,000	159.75

Issued, subscribed and fully paid up Non Convertible Redeemable Preference Shares:

	Non Convertible Redeemable Preference Shares	
	No. of Shares	Amount
	Rs. 10 each	
As at April 1, 2018 (Proforma)	1,36,05,863	136.06
Add : Issue of shares	-	-
As at March 31, 2019 (Proforma)	1,36,05,863	136.06
Add : Issue of shares	-	-
As at March 31, 2020	1,36,05,863	136.06
Add : Issue of shares	-	-
As at March 31, 2021	1,36,05,863	136.06

Details of shareholders more than 5% Non Convertible Redeemable Preference Shares in the Company

Name of the shareholder	As at March 31, 2021		As at March 31, 2020		As at March 31, 2019 (Proforma)	
	Nos.	% holding	Nos.	% holding	Nos.	% holding
<b>Non Convertible Redeemable Preference Shares of Rs. 10 each fully paid</b>						
Rupesh D Madeka	38,89,338	28.59%	38,89,338	28.59%	38,89,338	28.59%
Jiten D Madeka	18,14,338	13.33%	18,14,338	13.33%	18,14,338	13.33%
Ashok D Madeka	8,79,586	6.46%	8,79,586	6.46%	8,79,586	6.46%
Manesh D Madeka	15,69,338	11.53%	15,69,338	11.53%	15,69,338	11.53%
Pinakin D Madeka	13,71,797	10.08%	13,71,797	10.08%	13,71,797	10.08%
Bhautik D Madeka	20,67,045	15.19%	20,67,045	15.19%	20,67,045	15.19%

Annexure VII  
Notes to Restated Ind AS Summary Statements

Terms of conversion/ redemption of NCRPS

The company has issued non convertible redeemable preference shares with 0% dividend, to be redeemed at par on completion of 10 years from the date of allotment. In the event of liquidation of the company before redemption of non convertible redeemable preference shares, the holders of non convertible redeemable preference shares will have priority over equity shareholders in the payment of dividend and repayment of capital.

The company has issued preference shares under this right entitlement in following 3 phase as mentioned below-

- 66,80,000 NCRPS of 10 each at par totalling to INR 6,68,00,000 on 31st Dec 2013
- 16,80,000 NCRPS of 10 each at par totalling to INR 1,68,00,000 on 22d Feb 2014
- 52,45,863 NCRPS of 10 each at par to INR INR 5,24,58,630 on 01st Dec 2014

There is a contractual obligation to deliver cash to the preference shareholders as these preference shares are redeemable at par at the end of 10 years from the date of allotment. Hence, the principal amount of NCRPS is in the nature of financial liability as the Company has a contractual obligation to redeem this amount at the end of 10 years to the holders and the issuer cannot avoid this outflow at the end of 10th year. Consequently, the Company has initially measured preference shares at their fair value (plus transaction costs), being the present value of expected cash outflow discounted at the market-rate of dividend prevailing assumed by the company to be 10.25%/10.345%. Since the preference shares have a zero percent dividend, there is difference between cash amount and the fair value of preference shares on initial recognition. The equity portion of which has been accounted under other equity and not remeasured subsequently, whereas the financial liability is been measured at an Amortised cost. EIR computed by the company for each phase of issue is shown below-

- 66,80,000 NCRPS of 10 each at par totalling to INR 6,68,00,000 on 31st Dec 2013: 10.25% p.a.
- 16,80,000 NCRPS of 10 each at par totalling to INR 1,68,00,000 on 22d Feb 2014: 10.25% p.a.
- 52,45,863 NCRPS of 10 each at par to INR INR 5,24,58,630 on 01st Dec 2014: 10.345% p.a.

The Board of Directors in their meeting held on March 12, 2021 have approved the change in tenor of redemption from completion of 10 years from the date of allotment to completion of 10 years from the date of allotment or upon listing of equity shares of the Company on the stock exchanges, whichever is earlier. This is subject to approval of shareholders in ensuing meeting.

**10.3 Equity Component of Optionally Convertible Redeemable Preference Shares (OCRPS):**

Particulars	As at March 31, 2021		As at March 31, 2020		As at March 31, 2019 (Proforma)	
	No. of OCRPS	INR in million	No. of OCRPS	INR in million	No. of OCRPS	INR in million
<b>Authorised Shares:</b>						
Optionally Convertible Redeemable Preference Shares of INR 10 each	50,00,000	50.00	-	-	-	-
<b>Issued, subscribed and fully paid-up</b>						
Optionally Convertible Redeemable Preference Shares of INR 10 each	26,30,000	26.30	-	-	-	-
<b>Total</b>	<b>26,30,000</b>	<b>26.30</b>	<b>-</b>	<b>-</b>	<b>-</b>	<b>-</b>

**Details of shareholders holding more than 5 percent shares in the Equity component of Compound Financials Instruments of the company**

Particulars	As at March 31, 2021		As at March 31, 2020		As at March 31, 2019 (Proforma)	
	No. of OCRPS	% of holding	No. of OCRPS	% of holding	No. of OCRPS	% of holding
Rupesh D Madeka	4,27,636	16.26%	-	-	-	-
Jiten D Madeka	4,27,636	16.26%	-	-	-	-
Ashok D Madeka	1,46,590	5.57%	-	-	-	-
Manesh D Madeka	4,67,846	17.79%	-	-	-	-
Pinakin D Madeka	5,06,359	19.25%	-	-	-	-
Bhautik D Madeka	3,75,930	14.29%	-	-	-	-
Mihir R Madeka	80,181	3.05%	-	-	-	-
Hemal P Madeka	37,460	1.42%	-	-	-	-
Sanjay B Bole	80,181	3.05%	-	-	-	-
Bharat J Madeka	80,181	3.05%	-	-	-	-

Allotment of 26,30,000 Optionally Convertible Redeemable Preference Shares (hereinafter referred to as 'OCRPS') at Rs. 10/- per share, aggregating to Rs. 2,63,00,000/- in the ratio of 9 (Nine) OCRPS for every 44 (Forty Four) Equity shares held by the existing equity shareholders. Also based on the application forms received from existing equity shareholders, Shri Paresh Madeka and Rivendell PE LLC have not subscribed to this offer and Hemal P Madeka have not subscribed to full quota of shares offered.

**Terms and rights attached on Equity component of Compound Financial Instrument**

- OCRPS will have Zero percent coupon rate. Further, the said preference shares will not be entitled for any dividend during the currency of tenure.
- The OCRPS will be converted into Equity Shares in the manner as laid down here in under:
  - If the Company opts for the Initial Public Offer (IPO) in future, then the said OCRPS will be optionally converted into Equity Shares after filing of Draft Red Herring Prospectus but before filing of Red Herring Prospectus by the Company, for its IPO.
  - The OCRPS will be converted in to Equity Shares at a face value of Rs. 10/- each i.e. 1 Equity Share against 1 OCRPS and will not be converted at any premium value.
- The OCRPS holders shall have a right to vote only on such resolutions which directly affects rights attached to their preference shares.
- In case, the Member opt not to convert the shares into equity within 5(Five) years from date of allotment, then within 1 (one) year from expiry of such five years, the said OCRPS shall be redeemed at face value, and no premium to be paid at time of redemption of these OCRPS.
- In case of winding up of the Company, the holders of OCRPS shall have rights at par with holders of NCRPS.

**11 Other Equity:**

Particulars	As at March 31, 2021	As at March 31, 2020	As at March 31, 2019 (Proforma)
<b>Reserves and surplus:</b>			
Securities premium			
Balance as per last financial statements	1,626.14	1,626.14	1,626.14
Add : Addition during the year	-	-	-
Closing balance	<u>1,626.14</u>	<u>1,626.14</u>	<u>1,626.14</u>
Equity Component of Compound Financial Instruments*			
Balance as per the last financial statements	84.53	84.53	84.53
Add : On issue of OCRPS during the year	11.65	-	-
Closing balance	<u>96.18</u>	<u>84.53</u>	<u>84.53</u>
Retained earnings			
Opening balance	730.57	202.96	(387.22)
Add: Restated Profit for the year (net of taxes)	869.55	529.41	590.41
Items of Restated other comprehensive income recognised directly in retained earnings:			
Other comprehensive income/(expense) (net of taxes)	5.08	(1.80)	(0.23)
Closing balance	<u>1,605.20</u>	<u>730.57</u>	<u>202.96</u>
Total Reserves and surplus / other equity	<u><u>3,327.52</u></u>	<u><u>2,441.24</u></u>	<u><u>1,913.63</u></u>

Nature and Purpose of Reserves:

Securities Premium: Security premium is used to record the premium received on issue of shares. It is utilised in accordance with the provisions of Companies Act, 2013.

Retained Earnings: Retained Earnings are the profits of the company has earned till date, less any transfer to General reserve, dividends or other distributions paid to the shareholders.

Other Comprehensive Income: OCI includes re-measurement gain/losses on account of re-measurement defined benefit plans.

\*Equity Component of Compound Financial Instruments: The component parts of compound financial instruments issued by the company are classified as financial liabilities and equity in accordance with the substance of the contractual arrangements and the definitions of a financial liability and equity instrument. Financial liabilities are recognised initially at fair value net of directly attributable transaction costs and subsequently measured at an effective interest method. Equity component is not re-measured. Further, details are given Note 10.2 and 10.3.

Annexure VII

Notes to Restated Ind AS Summary Statements

12 Borrowings

12.1 Non-current Borrowings

	As at March 31, 2021	As at March 31, 2020	As at March 31, 2019 (Proforma)
<b>At amortised costs</b>			
Term loans (secured)			
Indian rupee loans from banks	543.84	559.28	1,425.95
Liability component of compound financial instruments:			
Non Convertible Preference Shares <sup>^</sup>	100.59	90.99	82.48
Optionally Convertible Redeemable Preference Shares-liability <sup>^^</sup>	14.76	-	-
	<u>659.19</u>	<u>650.27</u>	<u>1,508.43</u>
Less: Current maturities of long-term debts disclosed under the head other current financial liabilities (refer note 14)	(335.74)	(207.84)	(595.03)
<b>Total non-current borrowings</b>	<b><u>323.45</u></b>	<b><u>442.43</u></b>	<b><u>913.40</u></b>

<sup>^</sup> Note : 13,605,863 non convertible redeemable preference shares of Rs. 10 each were outstanding as on year end. These preference shares were issued with zero percent dividend and redeemable at par at the end of 10 years from allotment. Liability component of compound financial instrument are recognised initially at fair value net of directly attributable transaction costs and subsequently measured at an effective interest method. The details are given in Note - 10.2.

<sup>^^</sup> Note : 26,30,000 optionally convertible redeemable preference shares of Rs. 10 each were outstanding as on year end. These preference shares were issued with zero percent coupon rate and redeemable at par after filing DRHP and before filing RHP. Liability component of compound financial instrument is recognised initially at fair value net of directly attributable transaction costs and subsequently measured at an effective interest method. The details are given in Note 10.3.

The company has taken borrowings from various banks towards funding of its capital expenditure and working capital. A summary of security provided by the company is as follow

Facility Category	Security Details	As at March 31, 2021	As at March 31, 2020	As at March 31, 2019 (Proforma)
Term loan-Indian rupee loan	Primary : First pari-passu charge over the entire fixed assets of the company. Collateral : Second pari-passu charge over the entire current assets of the company. Loan is repayable in 20 - 32 Quarterly instalments by 31-03-2022 having interest in the range of 9.65% to 19.00%	251.28	424.27	1,063.42
Term loan-Indian rupee loan	Primary : First pari-passu charge over the entire fixed assets-present and future - comprising of immovable and movable assets( except Vehicle) of the company. Collateral : Second pari-passu charge over the entire current assets - present and future of the company. Loan is repayable in 20 - 32 Quarterly instalments by 31-03-2022 having interest in the range of 9.60% to 15.25%	84.46	135.01	307.04
Term loan - Indian Rupee Loan	Primary : First pari-passu charge over the entire fixed assets-present and future - comprising of immovable and movable assets( except Vehicle) of the company. Collateral : Second pari-passu charge over the entire current assets - present and future of the company. These COVID Loans are repayable in 48 equal monthly instalments after initial moratorium of 12 month having interest in the range of 7.82% to 8.35%	208.10	-	-
Term loan-Indian rupee loan	Exclusive charge by way of hypothecation of SMS Meer Machine (including accessories) Loan is repaid in 32 Quarterly instalments by 31-03-2020 having interest of 10.25%	-	-	55.49

Annexure VII

Notes to Restated Ind AS Summary Statements

12.2 Short term Borrowings

	As at March 31, 2021	As at March 31, 2020	As at March 31, 2019 (Proforma)
At amortised cost			
Secured			
Cash credit from bank	171.10	190.83	301.13
Other working capital facilities *	1,664.62	1,748.43	2,042.12
	<u>1,835.72</u>	<u>1,939.26</u>	<u>2,343.25</u>

\* Other Working capital facilities consist facility for packing credit in foreign currency (PCFC) and foreign usance discount bill purchase (FUDBP) facilities.

For Company financials risk movement, refer Note 36.

(i) The company has taken borrowings from various banks towards funding of its working capital. A summary of security provided by the company is as follows:

Facility Category	Security Details	As at March 31, 2021	As at March 31, 2020	As at March 31, 2019 (Proforma)
Cash credit facility	1. First pari-passu charge by way of Hypothecation on Stock and receivables/ current assets (both present and future) 2. Second pari-passu charge on the fixed assets of the company.	51.31	134.93	76.54
Cash credit facility	1. First pari-passu charge by way of hypothecation of stocks/ inventory and book debts/receivables of the company along with other consortium banks. 2. Second pari-passu charge on the fixed assets of the company.	30.15	37.32	65.53
Cash credit facility	1. First pari-passu charge over the entire current assets of the company. 2. Second pari-passu charge over the entire fixed assets of the company.	83.73	17.22	145.37
Cash credit facility	1. First Pari-passu charge on the CENVAT/ Gujarat/ VAT/ DEPB receivables of the company along with other consortium banks. 2. Second Pari-passu charge on fixed assets of the company.	5.91	1.36	13.69
Other working capital facilities*	1. First pari-passu charge by way of Hypothecation on Stock and receivables/ current assets (both present and future). 2. Second pari-passu charge on the fixed assets of the company.	289.53	453.77	489.04
Other working capital facilities*	1. First Pari-passu charge by the way of hypothecation of stocks and book debts of the company along with other consortium members. 2. Second pari-passu charge on advance shall be covered under Whole Turnover Packing Credit Guarantee obtained by the Bank from ECGC & premium to be borne by the clients.	294.65	462.43	531.95
Other working capital facilities*	1. First pari-passu charge over the entire current assets of the company. 2. Second pari-passu charge over the entire fixed assets of the company.	824.36	732.32	990.83
Other working capital facilities*	1. Documents of title to goods in case of L/C on DP basis 2. Hypothecation charge over the goods in case of L/C on DA basis	256.08	99.91	30.30

\*Other working capital facilities consist of letter of credit, packing credit and FUDBP facilities.

(ii) Terms of repayment of total borrowings outstanding as well as the interest rates prevailing as on March 31, 2021; March 31, 2020 and March 31, 2019 (proforma) are provided below:

Facility Category	Terms of repayment	Interest rate
Other working capital facilities	Within 1 year	3.5% - 10.5%
Cash credit	Repayable on demand	9.00% - 10.25%

Annexure VII

Notes to Restated Ind AS Summary Statements

13 Trade payables

	As at March 31, 2021	As at March 31, 2020	As at March 31, 2019 (Proforma)
Trade payables to:			
- micro and small enterprises (refer note 31)	19.20	14.76	25.43
- others than micro and small enterprises	1,157.15	723.71	887.56
<b>Total trade payables</b>	<b>1,176.35</b>	<b>738.47</b>	<b>912.99</b>

Terms and conditions of the above financial liabilities:

- a. Trade payables are non-interest bearing and are normally settled on 45-90 days terms.  
b. For explanations on the Company's financial risk management processes, refer to note 36.

14 Other financial liabilities

	As at March 31, 2021	As at March 31, 2020	As at March 31, 2019 (Proforma)
Current			
Current maturities of long term debts (refer note 12.1)	335.74	207.84	595.03
Other Interest Payable	-	1.34	25.53
Payables for Capital goods	44.95	7.57	6.74
Employee dues	53.28	44.47	43.88
<b>Total other current financial liabilities</b>	<b>433.97</b>	<b>261.22</b>	<b>671.18</b>

15 Other liabilities

	As at March 31, 2021	As at March 31, 2020	As at March 31, 2019 (Proforma)
Current			
Statutory dues payables*	10.44	8.43	13.23
Advance from customers	4.31	-	-
<b>Total other current liabilities</b>	<b>14.75</b>	<b>8.43</b>	<b>13.23</b>

\*Statutory dues payable includes payable on account of provident fund, tax deducted at source etc.

16 Provisions

	As at March 31, 2021	As at March 31, 2020	As at March 31, 2019 (Proforma)
Non-Current			
Provision for gratuity (refer note 27)	21.99	21.79	14.30
Provision for litigation	9.10	9.10	9.10
	<b>31.09</b>	<b>30.89</b>	<b>23.40</b>
Current			
Provision for gratuity (refer note 27)	7.27	7.19	6.52
	<b>7.27</b>	<b>7.19</b>	<b>6.52</b>
<b>Total provisions</b>	<b>38.36</b>	<b>38.08</b>	<b>29.92</b>

In pursuance of Ind AS 37 - 'Provisions, contingent liabilities and contingent assets', the provisions required have been incorporated in the following manner:

	As at March 31, 2021	As at March 31, 2020	As at March 31, 2019 (Proforma)
At the beginning of the year	9.10	9.10	9.10
Provision made during the year	-	-	-
At the end of the year	<b>9.10</b>	<b>9.10</b>	<b>9.10</b>

Annexure VII  
Notes to Restated Ind AS Summary Statements

17 Income taxes

(A) The major components of income tax expense are current tax and deferred tax :  
Restated Statement of profit and loss

	Year ended March 31, 2021	Year ended March 31, 2020	Year ended March 31, 2019 (Proforma)
Current income tax charge:			
Current income tax	130.42	127.17	308.90
Deferred tax			
Relating to origination and reversal of temporary differences	(248.12)	64.25	506.29
Income tax expense reported in the Restated Statement of Profit and Loss	(117.70)	191.42	815.19

(B) Income tax recognised in other comprehensive income

	Year ended March 31, 2021	Year ended March 31, 2020	Year ended March 31, 2019 (Proforma)
Remeasurements of defined benefit liability (asset)	(2.73)	0.97	0.12
	(2.73)	0.97	0.12

(C) Reconciliation of tax expenses and the accounting profit multiplied by applicable tax rate for respective year

	Year ended March 31, 2021	Year ended March 31, 2020	Year ended March 31, 2019 (Proforma)
Restated profit before tax	751.85	720.83	1,405.60
Tax as per India's statutory income tax rate	34.94%	34.94%	34.94%
Expected income tax expense as per applicable taxes	262.70	251.89	491.17
Tax benefit on brought forward tax losses not recognised in earlier years	-	(21.96)	(8.26)
Adjustments recognised in the current year in relation to the current tax of prior year	-	-	-
MAT paid/credit entitlement	(384.35)	(40.66)	308.90
Deferred Tax on other comprehensive income	(2.73)	0.97	0.12
Effect of expenses that are not deductible in determining taxable profit	0.36	1.60	10.95
Others	6.32	(0.42)	12.30
Effective income tax	(117.70)	191.42	815.19

(D) Deferred tax assets/ (liabilities)

	Balance sheet		
	As at March 31, 2021	As at March 31, 2020	As at March 31, 2019 (Proforma)
Deferred tax relates to the following			
Property, plant and equipment: Impact of difference between tax depreciation and depreciation/ amortisation charged for the financial reporting	(591.43)	(570.68)	(532.98)
Impact of Compound Financial Instruments	(16.69)	(15.96)	(18.72)
Disallowance towards doubtful debts and provisions for bonus, business promotion expenses, leave encashment, etc	14.56	17.19	13.64
Unabsorbed depreciation	-	-	31.89
Net deferred tax (liabilities)	(593.56)	(569.45)	(506.17)

Deferred tax liabilities reflected in the Balance Sheet as follows:

	Balance sheet		
	As at March 31, 2021	As at March 31, 2020	As at March 31, 2019 (Proforma)
Deferred tax liabilities	593.56	569.45	506.17
Less: Tax Credit entitlement in MAT	(269.50)	-	-
Deferred tax liabilities(net)	324.06	569.45	506.17

Reconciliation of deferred tax liabilities (net)

	Year ended March 31, 2021	Year ended March 31, 2020	Year ended March 31, 2019 (Proforma)
Opening balance	(569.45)	(506.17)	-
Tax expense recognised during the year in profit or loss	(21.38)	(64.25)	(506.29)
Tax credit and MAT recognised	269.50	-	-
Tax (income)/ expense during the year recognised in OCI	(2.73)	0.97	0.12
Closing balance	(324.06)	(569.45)	(506.17)

(E) Deferred tax charge

	Restated Statement of profit and loss		
	Year ended March 31, 2021	Year ended March 31, 2020	Year ended March 31, 2019 (Proforma)
Deferred tax charges relates to the movement in the following Items			
Accelerated depreciation/ amortisation for tax purposes	20.75	(37.70)	(89.17)
Change in fair value of financial instruments	0.73	2.76	(18.72)
Disallowance towards doubtful debts and provisions for bonus, business promotion expenses, leave encashment, etc	(2.83)	3.55	12.31
MAT Credit Entitlement	(269.50)	-	-
Unabsorbed depreciation	-	(31.89)	(410.59)
Net deferred tax income/ (expense)	(250.85)	(63.28)	(506.17)
Deferred tax charge as per Restated Statement of profit and loss	(248.12)	(64.25)	(506.29)
Deferred tax charge as per other comprehensive income	(2.73)	0.97	0.12
	(250.85)	(63.28)	(506.17)

Note: Deferred tax asset considering accumulated losses as a matter of prudence in absence of virtual certainty, was recognised only to the extent of deferred tax liability.

The Company offsets tax assets and liabilities only if it has a legally enforceable right to set off current tax assets and current tax liabilities and the deferred tax assets and deferred tax liabilities relate to income taxes levied by the same tax authority.

Rolex Rings Limited (formerly known as Rolex Rings Private Limited)

CIN: U28910GJ2003PLC041991

(All amount in Indian rupees million, unless otherwise stated)

Annexure VII

Notes to Restated Ind AS Summary Statements

18 Revenue from operations

	Year ended March 31, 2021	Year ended March 31, 2020	Year ended March 31, 2019 (Proforma)
Revenue from contracts with customers			
Sale of goods (Refer note below)	5,683.30	6,158.93	8,289.47
Total revenue from contracts with customers	5,683.30	6,158.93	8,289.47
Other operating revenue			
Scrap sales	334.24	264.94	431.54
Export incentives	94.92	158.07	242.08
Windmill income	50.86	78.00	80.14
Total other operating revenue	480.02	501.01	753.76
Total revenue from operations	6,163.32	6,659.94	9,043.23

Disclosure pursuant to Ind AS 115: Revenue from contract with customers

A Disaggregated revenue

(i) Revenue by geographical market

	Year ended March 31, 2021	Year ended March 31, 2020	Year ended March 31, 2019 (Proforma)
Within India	2,704.32	3,075.30	3,954.51
Outside India	3,459.00	3,584.64	5,088.72
	6,163.32	6,659.94	9,043.23

B Contract balances

	Year ended March 31, 2021	Year ended March 31, 2020	Year ended March 31, 2019 (Proforma)
Trade receivables (note 7)	1,708.01	1,276.72	1,814.96
Advance from customers (note 15)	4.31	-	-

C Reconciling the amount of revenue recognised in the Restated Statement of Profit and Loss with the contracted price

	Year ended March 31, 2021	Year ended March 31, 2020	Year ended March 31, 2019 (Proforma)
Revenue as per contracted price (recognised at a point of time)	5,683.30	6,158.93	8,289.47
Less: Discounts and rebates	-	-	-
Add/ (Less): Changes in revenue due to performance obligations (net)	-	-	-
Net revenue from contract with customers	5,683.30	6,158.93	8,289.47

19 Other income

	Year ended March 31, 2021	Year ended March 31, 2020	Year ended March 31, 2019 (Proforma)
Interest income on			
Bank deposits	10.94	10.18	10.95
Others	3.80	4.57	3.59
Foreign exchange differences (net)	17.28	76.51	49.36
Profit on sale of assets (net)	0.72	-	4.27
Miscellaneous Income	0.22	-	-
Rental Income	1.29	2.12	1.14
Total other income	34.25	93.38	69.31



Annexure VII

Notes to Restated Ind AS Summary Statements

20 Cost of raw materials and components consumed

	Year ended March 31, 2021	Year ended March 31, 2020	Year ended March 31, 2019 (Proforma)
Inventory at the beginning of the year	393.71	521.69	681.88
Add: purchases	3,257.60	3,009.43	4,369.17
	3,651.31	3,531.12	5,051.05
Less: inventory at the end of the year	485.37	393.71	521.69
Total cost of raw materials and components consumed	3,165.94	3,137.41	4,529.36

21 Decrease/ (increase) in inventories of finished goods and work-in-progress

	Year ended March 31, 2021	Year ended March 31, 2020	Year ended March 31, 2019 (Proforma)
Inventory at the end of the year			
Finished goods	720.43	553.18	654.69
Work-in-progress	400.68	276.33	330.74
	1,121.11	829.51	985.43
Inventory at the beginning of the year			
Finished goods	553.18	654.69	533.05
Work-in-progress	276.33	330.74	262.32
	829.51	985.43	795.37
Net decrease/ (increase) in inventories of finished goods and work-in-progress	(291.60)	155.92	(190.06)

22 Employee benefits expense

	Year ended March 31, 2021	Year ended March 31, 2020	Year ended March 31, 2019 (Proforma)
Salaries, wages and bonus	456.07	464.56	537.62
Contribution to provident fund and other funds	25.10	30.22	32.41
Gratuity expenses (refer note 27)	12.84	7.74	7.05
Staff welfare expenses	24.65	24.07	30.98
Total employee benefits expense	518.66	526.59	608.06

23 Finance Costs

	Year ended March 31, 2021	Year ended March 31, 2020	Year ended March 31, 2019 (Proforma)
Interest on bank borrowings	146.14	196.98	346.86
Interest on liability component of compound financial instrument	9.71	8.51	7.69
Interest on lease liabilities (Note 34)	0.12	0.15	0.17
Exchange differences regarded as an adjustment to borrowing costs	(83.04)	76.74	-
Other finance charges	44.06	39.31	65.47
Total finance costs	116.99	321.69	420.19

24 Depreciation and amortisation expenses

	Year ended March 31, 2021	Year ended March 31, 2020	Year ended March 31, 2019 (Proforma)
Depreciation of property, plant and equipment (refer note 3.1)	251.59	262.18	252.43
Depreciation of Right-of-use assets (refer note 3.2)	0.16	0.16	0.16
Amortisation of intangible assets (refer note 3.3)	2.34	2.90	1.81
Total depreciation and amortisation expenses	254.09	265.24	254.40

Annexure VII  
Notes to Restated Ind AS Summary Statements

25 Other expenses

	Year ended March 31, 2021	Year ended March 31, 2020	Year ended March 31, 2019 (Proforma)
Power and fuel	520.55	541.84	714.89
Repairs and maintenance			
Plant and machinery	32.85	36.01	43.70
Buildings	4.30	9.91	20.84
Others	6.35	7.84	3.74
Labour charges	252.75	229.65	199.01
Consumption of stores, spares and consumables	445.59	430.79	700.30
Sorting, segregation and testing charges	54.15	51.76	45.89
Windmill expenses (Note 33)	7.76	13.94	13.73
Freight and forwarding charges	245.75	229.03	245.70
Sales promotion	0.25	1.62	0.90
CSR expenses (Refer note below)	16.80	8.59	7.16
Travelling and conveyance	4.69	6.87	10.82
Rates and taxes	14.15	0.45	11.00
Insurance	46.97	26.62	23.37
Legal and professional fees	11.64	7.31	14.23
Printing and stationery	3.12	3.03	3.65
Loss on sale of property, plant and equipment (net)	-	0.45	-
Communication costs	2.65	2.62	4.31
Payment to auditors			
- Statutory Audit fees	1.00	1.00	0.90
Annual maintenance charges	6.77	7.03	4.70
Provision for impairment allowance of financial assets (net)	-	-	3.33
Donations	2.06	5.20	6.20
Miscellaneous expenses	1.49	4.08	6.62
<b>Total other expenses</b>	<b>1,681.64</b>	<b>1,625.64</b>	<b>2,084.99</b>

(i) Details of CSR expenditure

	Year ended March 31, 2021	Year ended March 31, 2020	Year ended March 31, 2019 (Proforma)
a) Gross amount required to be spent by the Company during the year	16.80	17.98	13.93
b) The revenue expenditure charged to the Statement of Profit or Loss by the Company during the year	16.80	8.59	7.16
(I) Amount spent by company during the year in cash			
i) Construction/ acquisition of any asset	-	-	-
ii) On purposes other than (i) above	1.70	8.59	7.16
(II) Amount Yet to be paid by company			
i) Construction/ acquisition of any asset	-	-	-
ii) On purposes other than (i) above	15.10	9.39	6.77
(III = I + II) Total			
i) Construction/ acquisition of any asset	-	-	-
ii) On purposes other than (i) above	16.80	17.98	13.93

In case of S. 135(5) (Other than ongoing project)

Opening Balance	Amount deposited in Specified Fund of Sch. VII within 6 months	Amount required to be spent during the year	Amount spent during the year	Closing Balance
-	-	16.80	1.70	15.10

(ii) Details of payment to auditors

	For the year ended March 31, 2021	For the year ended March 31, 2020	Year ended March 31, 2019 (Proforma)
As auditor:			
Audit fees	1.00	1.00	0.90
Tax audit fees	-	-	-
Reimbursement of expenses	-	-	-

Rolex Rings Limited (formerly known as Rolex Rings Private Limited)

CIN: U28910GJ2003PLC041991

(All amount in Indian rupees million, unless otherwise stated)

Annexure VII

Notes to Restated Ind AS Summary Statements

26 Earnings per share

Basic and Diluted EPS amounts are calculated by dividing the profit for the year attributable to equity shareholders by the weighted average number of Equity shares outstanding during the year.

The following table reflects the income and earnings per share data used in the basic and diluted EPS computation:

Disclosure as required by Ind AS 33 is shown below -

	Year ended March 31, 2021	Year ended March 31, 2020	Year ended March 31, 2019 (Proforma)
Restated profit for the year attributable to equity shareholders of the company for basis (INR in Million)	869.55	529.41	590.41
Restated profit attributable to equity holders adjusted for the effect of dilution (INR in Million) (a)	869.55	529.41	590.41
Weighted average number of equity shares in calculating basic EPS (b)	2,39,81,090	2,39,81,090	2,39,81,090
Weighted average number of equity shares in calculating diluted EPS (c)	2,41,82,843	2,39,81,090	2,39,81,090
Nominal value of shares (Rs.)	10	10	10
Basic earnings per share (Rs.) (d) = (a)/(b)	36.26	22.08	24.62
Diluted earnings per share (Rs.) (e) = (a)/(c)	35.96	22.08	24.62

27 Gratuity and other Post employment benefit plans

A. Defined Contribution plan:

During the year, the Company has made contribution/provision to provident fund stated under defined contribution plan as stated below:

	Year ended March 31, 2021	Year ended March 31, 2020	Year ended March 31, 2019 (Proforma)
Contribution to Provident Fund	25.10	30.22	32.41

B. Defined Benefit Plans

Gratuity:

The Company operates a defined gratuity plan. Under the plan, every employee who has completed at least five years of service gets a gratuity on departure at 15 days of last drawn salary for each completed year of service. The scheme is funded with Life Insurance Company of India (LIC) in the form of a qualifying insurance policy for future payment of gratuity to the employees.

The liability or asset recognised in the balance sheet in respect of defined benefit gratuity plans is the present value of the defined benefit obligation at the end of the reporting year less the fair value of plan assets. The cost of providing benefits under the defined benefit plan is determined using the projected unit credit method.

The following tables summarises the components of net benefit expense recognised in the Restated Ind AS Summary Statement of Profit and Loss, the funded status and amounts recognised in Summary Statement of Assets and Liabilities for the plan.

Net employee benefit expense / (income) recognised in statement of profit and loss in respect of these defined benefit expenses

	Year ended March 31, 2021	Year ended March 31, 2020	Year ended March 31, 2019 (Proforma)
Current service cost	7.19	6.52	5.87
Interest cost on benefit obligation	2.29	1.82	1.48
Expected return on plan assets	0.70	(0.60)	(0.31)
Past service cost	2.66	-	-
Net benefit expense recognised in the Restated Ind AS Summary Statement of Profit and Loss	12.84	7.74	7.05

Annexure VII

Notes to Restated Ind AS Summary Statements

Amount recognised in the statement of other comprehensive income

	Year ended March 31, 2021	Year ended March 31, 2020	Year ended March 31, 2019 (Proforma)
Actuarial losses/ (gain) arising from changes in financial assumptions	0.35	1.08	(0.47)
Actuarial (gains) arising from changes in experience assumptions	(8.49)	1.36	0.51
Return on plan assets excluding amounts included in interest income	0.33	0.33	0.31
<b>Total re-measurement costs/ (income) for the year recognised in other comprehensive income</b>	<b>(7.81)</b>	<b>2.77</b>	<b>0.35</b>

Changes in the present value of the defined benefit obligation are as follows :

Net benefit liability/ (asset)

	As at March 31 , 2021	As at March 31, 2020	As at March 31, 2019 (Proforma)
Present value of defined benefit obligation	(40.99)	(39.70)	(28.94)
Fair value of plan assets	11.73	10.72	8.12
Plan liability	(29.26)	(28.98)	(20.82)

Changes in the present value of the defined benefit obligation are as follows:

	As at March 31 , 2021	As at March 31, 2020	As at March 31, 2019 (Proforma)
Opening defined benefit obligation	39.70	28.94	22.32
Current service cost	7.19	6.52	5.87
Interest cost	2.29	1.81	1.48
Benefits paid	(0.05)	(0.01)	(0.69)
Actuarial (gains) / losses on obligation	(8.14)	2.44	(0.04)
Closing defined benefit obligation	40.99	39.70	28.94

Changes in the fair value of plan assets are as follows :

	As at March 31 , 2021	As at March 31, 2020	As at March 31, 2019 (Proforma)
Opening fair value of plan assets	10.72	8.12	5.01
Expected return	0.70	0.60	0.31
Contributions by the employer	0.69	2.35	3.87
Benefits paid	(0.05)	(0.01)	(0.69)
Actuarial gains / (losses)	(0.33)	(0.33)	(0.38)
Fair value of plan assets at the end of the year	11.73	10.72	8.12

Bifurcation of the liability between current and non-current

	As at March 31, 2021	As at March 31, 2020	As at March 31, 2019 (Proforma)
Current liability**	7.27	7.19	6.52
Non-current liability	21.99	21.79	14.30
	<b>29.26</b>	<b>28.98</b>	<b>20.82</b>

\*\* The current liability is calculated as expected contributions for the next 12 months

The major categories of plan assets of the fair value of the total plan assets are as follows:

	As at March 31, 2021	As at March 31, 2020	As at March 31, 2019 (Proforma)
Nature of plan assets			
Policy of insurance	100%	100%	100%

The principal assumptions used in determining gratuity obligations for the Company's plan are shown below:

	As at March 31, 2021	As at March 31, 2020	As at March 31, 2019 (Proforma)
Discount rate	6.05%	6.25%	6.95%
Expected return on plan assets	6.05%	6.25%	6.95%
Salary escalation	4.50%	4.50%	4.50%
Employee turnover	30% at younger ages reducing to 5% at older ages	30% at younger ages reducing to 5% at older ages	30% at younger ages reducing to 5% at older ages
Mortality table	Indian Assured Lives Mortality (2012-14)	Indian Assured Lives Mortality (2012-14)	Indian Assured Lives Mortality (2012-14)
Retirement Age	58 Years	58 Years	58 Years

Annexure VII  
Notes to Restated Ind AS Summary Statements

Amounts for the current and previous years are as follows:

	As at March 31, 2021	As at March 31, 2020	As at March 31, 2019 (Proforma)
Gratuity			
Defined benefit obligation	40.99	39.70	28.93
Plan assets	11.73	10.72	8.12
Surplus / (deficit)	(29.26)	(28.98)	(20.82)
Experience adjustments on plan liabilities	(8.14)	1.36	(0.51)
Experience adjustments on plan assets	(0.33)	0.33	0.39

The estimates of future salary increases, considered in actuarial valuation, take account of inflation, seniority, promotion and other relevant factors, such as supply and demand in the employment market. The overall expected rate of return on assets is determined based on the market prices prevailing on that date, applicable to the period over which the obligation is to be settled.

A description of methods used for sensitivity analysis and its Limitations:

Sensitivity analysis is performed by varying a single parameter while keeping all the other parameters unchanged. Sensitivity analysis fail to focus inter-relationship between underlying parameters. Hence, the results may vary if two or more variables are changed simultaneously. the method used does not indicate anything about the likelihood of change in any parameter and the extent of the change if any.

Particulars	As at March 31, 2021	As at March 31, 2020	As at March 31, 2019 (Proforma)
<b>Discount Rate Sensitivity</b>			
Increase by 0.5% (% change)	(10.88) (2.10%)	(9.95) (1.96%)	(7.53) (2.03%)
Decrease by 0.5% (% change)	12.64 2.20%	11.54 2.05%	(8.73) 2.12%
<b>Salary growth Rate Sensitivity</b>			
Increase by 0.5% (% change)	12.64 2.21%	11.53 2.04%	(8.74) 2.16%
Decrease by 0.5% (% change)	(10.88) (2.10%)	(67.91) (1.96%)	(7.52) (2.06%)
<b>Withdrawal Rate (W.R.) Sensitivity</b>			
W.R. x 110% (% change)	(11.72) (0.03%)	(10.48) (0.61%)	(7.87) (0.84%)
W.R. x 90% (% change)	11.71 (0.06%)	10.93 0.52%	(8.33) 0.73%

The following are the expected future benefit payments for the defined benefit plan :

Particulars	As at March 31, 2021	As at March 31, 2020	As at March 31, 2019 (Proforma)
Within the next 12 months (next annual reporting period)	8.11	6.17	5.55
Between 2 and 5 years	23.41	21.44	17.33
Beyond 5 years	12.84	11.99	10.14
<b>Total expected payments</b>	<b>44.36</b>	<b>39.60</b>	<b>33.02</b>

28 Related party transactions

A Name of related parties and their relationships

Description of the Relationship

A. Key management personnel

Name of Related Parties

Mr. Manesh D Madeka (Chairman & Managing Director)  
Mr. Bhautik D Madeka (Whole time Director)  
Mr. Mihir D Madeka (Whole time Director)  
Mr. Hardik Gandhi (Company Secretary)  
Mr. Hireen Doshi (Chief Financial Officer) (w.e.f March 12, 2021)

B. Relatives of key management personnel

Mr. Hemal P. Madeka  
Mr. Bharat J Madeka  
Mr. Pares D Madeka  
Mr. Rupesh D Madeka  
Mr. Jiten D Madeka  
Mr. Ashok D Madeka  
Mr. Pinakin D Madeka  
Mr. Sanjay B Bole

C. Entity in which relative of key managerial personnel has control

M/s. Fillenpac Industries Private Limited  
M/s. Rapid cut

Annexure VII  
Notes to Restated Ind AS Summary Statements

28 Related party transactions (continue)

B Related party transactions and balances

The following table provides the total amount of transactions that have been entered into with related parties for the relevant year.

	Year ended March 31, 2021	Year ended March 31, 2020	Year ended March 31, 2019 (Proforma)
<b>a. Transactions during the year</b>			
<b>(i) Interest Income</b>			
Mr. Manesh Madeka	0.92	1.10	1.10
Mr. Bhautik Madeka	0.69	0.83	0.83
Mr. Mihir Madeka	0.69	0.83	0.83
M/s. Fillenpac Industries Pvt Ltd	-	-	0.65
<b>(ii) Remuneration paid</b>			
<b>Salary allowances and bonus *</b>			
Mr. Manesh Madeka	9.60	10.75	11.04
Mr. Bhautik Madeka	9.36	9.41	8.28
Mr. Mihir Madeka	8.40	8.06	6.90
Mr. Hemal Madeka	6.60	6.72	6.90
Mr. Bharat Madeka	8.40	8.06	6.90
Mr. Paresh Madeka	0.60	0.67	0.69
Mr. Rupesh Madeka	7.20	6.72	5.52
Mr. Jiten Madeka	7.20	6.72	5.52
Mr. Ashok Madeka	4.80	5.38	4.35
Mr. Pinakin Madeka	7.20	6.72	5.52
Mr. Sanjay Bole	1.50	1.68	1.73
Mr. Hardik Gandhi	0.17	0.17	0.17
Mr. Hiren Doshi (w.e.f March 12, 2021)	0.19	-	-
<b>(iii) Scrap sales</b>			
M/s. Rapid Cut	3.31	2.90	1.32
<b>(iv) Rental Income</b>			
M/s. Rapid Cut	0.42	0.42	0.18
<b>(v) Labour charges</b>			
M/s. Rapid Cut	5.90	7.20	5.22
<b>b. Closing balance</b>			
<b>(i) Trade Receivable</b>			
M/s. Fillenpac Industries Private Limited	-	6.19	7.50
M/s. Rapid cut	-	0.03	-
<b>(ii) Trade Payable</b>			
M/s. Rapid cut	0.36	-	0.93
<b>(iii) Outstanding Balance</b>			
Mr. Manesh Madeka	0.09	1.95	-
Mr. Bhautik Madeka	-	1.71	-
Mr. Mihir Madeka	-	1.46	-
Mr. Hardik Gandhi	0.01	0.01	0.01
Mr. Hemal Madeka	-	1.22	-
Mr. Bharat Madeka	-	1.46	-
Mr. Paresh Madeka	0.22	0.12	-
Mr. Rupesh Madeka	0.02	1.22	-
Mr. Jiten Madeka	3.40	1.22	-
Mr. Ashok Madeka	6.31	0.98	0.28
Mr. Pinakin Madeka	-	1.22	-
Mr. Sanjay Bole	0.01	0.13	-
Mr. Hiren Doshi (w.e.f March 12, 2021)	0.29	-	-
<b>(iv) Advance Remuneration</b>			
Mr. Manesh Madeka	-	-	0.80
Mr. Bhautik Madeka	-	-	0.70
Mr. Mihir Madeka	-	-	0.60
Mr. Hemal Madeka	-	-	0.50
Mr. Bharat Madeka	-	-	0.60
Mr. Paresh Madeka	-	-	0.05
Mr. Rupesh Madeka	-	-	0.50
Mr. Jiten Madeka	-	-	0.50
Mr. Pinakin Madeka	-	-	0.50
Mr. Sanjay Bole	-	-	0.13

Annexure VII  
Notes to Restated Ind AS Summary Statements

	As at March 31, 2021	As at March 31, 2020	As at March 31, 2019 (Proforma)
(v) Loan (Refer i below)			
Mr. Manesh Madeka	-	10.00	10.00
Mr. Bhautik Madeka	-	7.50	7.50
Mr. Mihir Madeka	-	7.50	7.50
M/s. Fillenpac Industries Private Limited	-	-	8.30
(vi) Interest receivable			
Mr. Manesh Madeka	-	-	1.10
Mr. Bhautik Madeka	-	-	0.83
Mr. Mihir Madeka	-	-	0.83
M/s. Fillenpac Industries Pvt Ltd	-	-	0.64

\* The remuneration does not include gratuity since the same is calculated for all the employees of the Company as a whole.

Notes

Loans given to Directors of the Company

(i) Included in loans and advances given are loans given to directors of the Company, the particular of which are disclosed in note no. 4, as required by section 186(4) of the Companies Act, 2013.

(ii) The unsecured loans are given to the directors of the company at a rate of interest of 11% p.a.

(iii) The company's transactions with related parties are at arm's length. managerial believes that the company's domestic and international transactions with related parties post March 31, 2020 continue to be at arm's length and that the transfer pricing legislation will not have any impact on the financial statements particularly on the amount of the tax expense for the year and the amount of the provision for taxation at the year end.

29 Capital and other commitments

	As at March 31, 2021	As at March 31, 2020	As at March 31, 2019 (Proforma)
(i) Estimated amount of contracts remaining to be executed and not provided for (net of advances)	328.53	237.07	201.61
ii) For commitments relating to lease arrangements, refer note 34.			

30 Contingent liabilities

	As at March 31, 2021	As at March 31, 2020	As at March 31, 2019 (Proforma)
Disputed Income tax/ Sales tax/ Service tax			
i) Income tax with respect to matters relating to disallowance of additional depreciation, disallowance of forex loss, disallowance of foreign commission and disallowance of other expenditure for the assessment years 2005-06 to 2017-18 in respect of which the Company has filed an appeal with higher authorities	138.73	104.01	104.01
ii) For non receipt of the required forms and non acceptance of the companies claim of certain sales as an exempted sales and related matters	0.25	0.25	14.39
iii) Service tax with respect to the matters decided against the company in respect of which the company as filed appeal with higher authorities	1.41	1.41	3.19
<b>Total</b>	<b>140.39</b>	<b>105.67</b>	<b>121.59</b>

The management based on the assessment, believes that the outcome of these contingencies will be favourable, but not probable and accordingly no provision has been recognised in the Financial Statement. The cash outflows with regards to above matters will be dependent on outcome of above pending cases.

Provision for Provident Fund:

There are numerous interpretative issues relating to the Supreme Court (SC) judgement on PF dated 28th February, 2019. The company has adopted the basis as mentioned in the SC judgement prospectively with effect from April 1, 2019.

Rolex Rings Limited (formerly known as Rolex Rings Private Limited)

CIN: U28910GJ2003PLC041991

(All amount in Indian rupees million, unless otherwise stated)

Annexure VII

Notes to Restated Ind AS Summary Statements

31 Details of dues to micro and small enterprises as defined under the Micro, Small and Medium Enterprise Development Act, 2006 (MSMED Act, 2006)

Particulars	As at March 31, 2021	As at March 31, 2020	As at March 31, 2019 (Proforma)
The principal amount and the interest due thereon remaining unpaid to any supplier as at the end of each year			
-- Principal amount due to micro and small enterprises	18.91	14.58	25.35
-- Interest due on above	0.29	0.18	0.08
	<u>19.20</u>	<u>14.76</u>	<u>25.43</u>
The amount of interest paid by the buyer in terms of section 16, of the MSMED Act, 2006 along with the amounts of the payment made to the supplier beyond the appointed day during each accounting year	-	-	-
The amount of interest due and payable for the period of delay in making payment (which have been paid but beyond the appointed day during the year) but without adding the interest specified under MSMED Act, 2006	-	-	-
The amount of interest accrued and remaining unpaid at the end of each accounting year	0.47	0.18	0.08
The amount of further interest remaining due and payable even in the succeeding years, until such date when the interest dues as above are actually paid to the small enterprise for the purpose of disallowance as a deductible expenditure under section 23 of the MSMED Act, 2006	-	-	-

The above information regarding Micro, Small and Medium Enterprise has been determined to the extent such parties have been identified on the basis of information available with the company. This has been relied upon by the auditors.

32 Segment reporting

Operating Segments

A Basis for segmentation

The company is mainly engaged in the business of manufacturing and selling of machined / forged rings and auto components. The company's business falls within a single business segment of 'diversified auto components' and all the activities of the Company revolve around the main business.

The Chief Operating decision maker (CODM) monitors the operating results of the business as a whole for the purpose of making decisions about resource allocation and performance assessment.

Therefore, management views company's business activity as a single segment and segment's performance is evaluated based on profit or loss and is measured consistently with profit or loss in the financial statements.

B Geographical information

The management evaluates that the company operates in two principal geographical areas - India and Outside India.

The below table sets out present revenue, expenditure and certain asset information regarding the company's geographical segments:

Sales of Products and others	Year ended March 31, 2021	Year ended March 31, 2020	Year ended March 31, 2019 (Proforma)
India	2,704.32	3,075.30	3,954.51
Outside India	3,459.00	3,584.64	5,088.72
Total	<u>6,163.32</u>	<u>6,659.94</u>	<u>9,043.23</u>

Other Non Current non financial assets	As at March 31, 2021	As at March 31, 2020	As at March 31, 2019 (Proforma)
India	4,023.66	3,853.95	3,964.29
Outside India	-	-	-
Total	<u>4,023.66</u>	<u>3,853.95</u>	<u>3,964.29</u>



Rolex Rings Limited (formerly known as Rolex Rings Private Limited)

CIN: U28910GJ2003PLC041991

(All amount in Indian rupees million, unless otherwise stated)

Annexure VII

Notes to Restated Ind AS Summary Statements

C Major External Customers

For the year ended March 31, 2021

The company has assessed that there are two customers from which the revenue from transactions is 10% or more of the company's total revenue for the year ended March 31, 2021.

Total amount of revenues from the customers is INR 1,934 million for the year ended March 31, 2021.

For the year ended March 31, 2020

The company has assessed that there is one customer from which the revenue from transactions is 10% or more of the company's total revenue for the year ending March 31, 2020. Total amount of revenues from the customer is INR 1,579.80 million for the year ended March 31, 2020.

For the year ended March 31, 2019

The company has assessed that there are three customers from which the revenue from transactions is 10% or more of the company's total revenue for the year ending March 31, 2019. Total amount of revenues from the customers is INR 3,517.81 million for the year ended March 31, 2019

33 Operating leases

The Company has entered into lease agreement for lease of land for windmill farm. The said agreement does not provide for increase in rent during the tenure of the agreement. Both the Company and lessor are entitled to terminate the lease by giving one month's notice to the other party. Rent income recognised in the Statement of Profit and Loss for the year in Note 19.

34 Leases

The company has lease contracts of two Lands used in its operations. The lease terms of lands are between 15 to 20 years. The company has evaluated that it does not have any short term and lease of low value assets. The company has identified that its job work contracts and warehousing agreements does not qualify under 'lease'.

The company has opted to apply for 'Full retrospective' as its transition approach under Ind AS 116 from the date of lease commencement. The Company applied the standard only to contracts that were previously identified as leases applying Ind AS 17 at the date of initial application.

Lease payments evaluated by the company are payments fixed in nature with company not exercising any termination or renewal options to terminate or extend the original lease term.

The initial direct costs are taken in consideration while accounting for the Right-of use asset.

The lease period for computation of lease is taken as 20 years from the date of commencement of each land lease.

Useful life of ROU asset for computation of amortisation expense on ROU assets is assumed to be the term of the lease and method used is Straight-line method.

The Company has applied the available practical expedients wherein it:

- Used a single discount rate to a portfolio of leases with reasonably similar characteristics.
- Applied the short-term leases exemptions to leases with lease term that ends within 12 months of the date of initial application.

For details on Right to use assets, refer note 3.2

The carrying amounts of lease liabilities and the movements during the year:

i)	Right-of-use Assets	As at March 31, 2021	As at March 31, 2020	As at March 31, 2019 (Proforma)
	Land (Note 3.2)			
	At the beginning of the year	0.66	0.82	0.82
	Additions	-	-	-
	Deletions	-	-	-
	Depreciation expenses (Note 3.2)	0.16	0.16	-
	At the end of the year	<u>0.50</u>	<u>0.66</u>	<u>0.82</u>

Rolex Rings Limited (formerly known as Rolex Rings Private Limited)

CIN: U28910GJ2003PLC041991

(All amount in Indian rupees million, unless otherwise stated)

Annexure VII

Notes to Restated Ind AS Summary Statements

ii) Leased Liabilities	As at March 31, 2021	As at March 31, 2020	As at March 31, 2019 (Proforma)
At the beginning of the year	1.33	1.57	1.79
Additions	-	-	-
Accretion of interest	0.12	0.15	0.17
Payments	(0.39)	(0.39)	(0.39)
At the end of the year	<u>1.06</u>	<u>1.33</u>	<u>1.57</u>

Leased Liabilities	As at March 31, 2021	As at March 31, 2020	As at March 31, 2019 (Proforma)
Current	0.39	0.39	0.39
Non-current	0.67	0.94	1.18
	<u>1.06</u>	<u>1.33</u>	<u>1.57</u>

(iii) Amount recognised in Statement of Profit and loss during the year

Particular	Year ended March 31, 2021	Year ended March 31, 2020	Year ended March 31, 2019 (Proforma)
(Note 23 and 24)			
Depreciation expense of right-of-use assets	0.16	0.16	0.16
Interest expense on lease liabilities	0.12	0.15	0.17
	<u>0.28</u>	<u>0.31</u>	<u>0.33</u>

(iv) Amount recognised in Cashflow Statement

Particular	As at March 31, 2021	As at March 31, 2020	As at March 31, 2019 (Proforma)
Cash outflow for leases	0.39	0.39	0.39
	<u>0.39</u>	<u>0.39</u>	<u>0.39</u>

(All amount in Indian rupees million, unless otherwise stated)

Annexure VII

Notes to Restated Ind AS Summary Statements

35 (A) Fair values

Set out below, is a comparison by class of the carrying amounts and fair value of the Company's financial instruments, other than those with carrying amounts that are reasonable approximations of fair values:

	(INR in million)		
	Carrying value		
	As at March 31, 2021	As at March 31, 2020	As at March 31, 2019 (Proforma)
Financial assets carried at amortised cost			
Loans to Directors (Note 4)	-	25.00	33.30
Security Deposits (Note 5)	4.57	5.17	5.43
Deposits with remaining maturity of more than twelve months (Note 5)	118.96	15.90	106.94
Financial liabilities carried at amortised cost			
Term loan from banks (Note 12)	208.10	351.44	830.92
Non Convertible Preference Shares - Liability component of compound Financial instruments (Note 12)	100.59	90.99	82.48
Optionally Convertible Redeemable Preference Shares - Liability component of compound Financial instruments (Note 12)	14.76		
Lease Liabilities - Non current (Note 34)	0.67	0.94	1.18

Note:

The management has assessed that the carrying amounts of the above financial instruments approximate their fair values.

The management assessed that carrying values of financial assets i.e., cash and cash equivalents, Loans, trade payables and trade receivables and other current assets and liabilities as at March 31, 2021, March 31, 2020 and March 31, 2019 (Proforma) are reasonable approximations of their fair values largely due to the short-term maturities of these instruments.

The fair value of the financial assets and liabilities is included at the amount at which the instrument could be exchanged in a current transaction between willing parties, other than in a forced or liquidation sale.

The fair value of the financial assets and liabilities is included at the amount at which the instrument could be exchanged in a current transaction between willing parties, other than in a forced or liquidation sale. The following methods and assumptions were used to estimate the fair values:

The liability component of a compound financial instrument is initially recognised at the fair value of a similar liability. Subsequently, this liability component is measured at amortised costs using effective interest method. Any initial directly attributable transaction costs are allocated to the liability and equity portion in the proportion of their initial carrying amounts.

The value of lease liability is determined by taking the present values of all the future outflows at an incremental borrowing rates applicable to the lessee.

Rolex Rings Limited (formerly known as Rolex Rings Private Limited)  
 (All amount in Indian rupees million, unless otherwise stated)  
 Annexure VII  
 Notes to Restated Ind AS Summary Statements

35 (B) Fair value hierarchy

The following table provides the fair value measurement hierarchy of the Company's assets and liabilities.

Quantitative disclosures fair value measurement hierarchy for assets/liabilities as at 31 March, 2021:

	Fair value measurement using			
	Total	Quoted prices in active markets (Level 1)	Significant observable inputs (Level 2)	Significant unobservable inputs (Level 3)
	INR in Million	INR in Million	INR in Million	INR in Million
Financial Asset carried at amortised cost				
Loans to Directors (Note 4)	-	-	-	-
Deposits with remaining maturity of more than twelve months (Note 5)	118.96			118.96
Trade Receivables (Note 7)	1,708.01	-	-	1,708.01
Security Deposits (Note 5)	4.57	-	-	4.57
Loans and Advances to Employees (Note 4)	0.76	-	-	0.76
Export Incentive Receivable (Note 5)	60.98	-	-	60.98
Cash and cash equivalents (Note 8)	46.12	-	-	46.12
Financial Liabilities at amortised cost				
Term loan from banks (Note 12)	208.10	-	-	208.10
Non Convertible Preference Shares - Liability component of compound Financial instruments (Note 12)	100.59	-	-	100.59
Lease Liabilities - Non current (Note 34)	0.67	-	-	0.67
Short term Borrowings (Note 12)	1,835.72	-	-	1,835.72
Trade Payables (Note 13)	1,176.35	-	-	1,176.35
Current maturities of Borrowings - Non current (Note 14)	335.74	-	-	335.74
Employee dues (Note 14)	53.28	-	-	53.28
Lease Liabilities - Current (Note 34)	0.39	-	-	0.39
Payables for capital goods (Note 14)	44.95	-	-	44.95

Rolex Rings Limited (formerly known as Rolex Rings Private Limited)  
 (All amount in Indian rupees million, unless otherwise stated)  
 Annexure VII  
 Notes to Restated Ind AS Summary Statements

Quantitative disclosures fair value measurement hierarchy for assets/liabilities as at 31 March 2020:

	Fair value measurement using			
	Total	Quoted prices in active markets (Level 1)	Significant observable inputs (Level 2)	Significant unobservable inputs (Level 3)
	INR in Million	INR in Million	INR in Million	INR in Million
Financial Asset carried at amortised cost				
Loans to Directors (Note 4)	25.00	-	-	25.00
Deposits with remaining maturity of more than twelve months (Note 5)	15.90	-	-	15.90
Trade Receivables (Note 7)	1,276.72	-	-	1,276.72
Security Deposits (Note 5)	5.17	-	-	5.17
Loans and Advances to Employees (Note 4)	0.97	-	-	0.97
Export Incentive Receivable (Note 5)	58.30	-	-	58.30
Cash and cash equivalents (Note 8)	12.45	-	-	12.45
Financial Liabilities at amortised cost				
Term loan from banks (Note 12)	351.44	-	-	351.44
Non Convertible Preference Shares - Liability component of compound Financial instruments (Note 12)	90.99	-	-	90.99
Lease Liabilities - Non current (Note 34)	0.94	-	-	0.94
Short term Borrowings (Note 12)	1,939.26	-	-	1,939.26
Trade Payables (Note 13)	738.47	-	-	738.47
Current maturities of Borrowings - Non current (Note 14)	207.84	-	-	207.84
Interest Accrued on Borrowings and others (Note 14)	-	-	-	-
Employee dues (Note 14)	44.47	-	-	44.47
Lease Liabilities - Current (Note 34)	0.39	-	-	0.39
Payables for capital goods (Note 14)	7.57	-	-	7.57

Rolex Rings Limited (formerly known as Rolex Rings Private Limited)  
 (All amount in Indian rupees million, unless otherwise stated)  
 Annexure VII  
 Notes to Restated Ind AS Summary Statements

Quantitative disclosures fair value measurement hierarchy for assets/liabilities as at March 31, 2019 (Proforma):

	Fair value measurement using			
	Total	Quoted prices in active markets (Level 1)	Significant observable inputs (Level 2)	Significant unobservable inputs (Level 3)
	INR in Million	INR in Million	INR in Million	INR in Million
Financial Asset carried at amortised cost				
Loans to Directors (Note 4)	33.30	-	-	33.30
Deposits with remaining maturity of more than twelve months (Note 5)	106.94	-	-	106.94
Trade Receivables (Note 7)	1,814.96	-	-	1,814.96
Security Deposits (Note 5)	5.43	-	-	5.43
Loans and Advances to Employees (Note 4)	1.23	-	-	1.23
Export Incentive Receivable (Note 5)	92.29	-	-	92.29
Cash and cash equivalents (Note 8)	1.38	-	-	1.38
Financial Liabilities at amortised cost				
Term loan from banks (Note 12)	830.92	-	-	830.92
Non Convertible Preference Shares - Liability component of compound Financial instruments (Note 12)	82.48	-	-	82.48
Lease Liabilities - Non current (Note 34)	1.18	-	-	1.18
Short term Borrowings (Note 12)	2,343.25	-	-	2,343.25
Trade Payables (Note 13)	912.99	-	-	912.99
Current maturities of Borrowings - Non current (Note 14)	595.03	-	-	595.03
Interest Accrued on Borrowings and others (Note 14)	-	-	-	-
Employee dues (Note 14)	43.88	-	-	43.88
Lease Liabilities - Current (Note 34)	0.39	-	-	0.39
Payables for capital goods (Note 14)	6.74	-	-	6.74

For the year ended March 31, 2021, March 31, 2020 and March 31, 2019 (Proforma) there were no transfers between Level 1 and Level 3 fair value measurements.

36 Financial risk management objectives and policies

The Company's principal financial liabilities comprises of Loan from banks, liability portion of compound financial instrument, lease liabilities, employee dues and trade payables . The purpose of these financial liabilities is to finance the Company's operations. The Company's principal financial assets include trade receivables, loans & advances to employees including directors , security deposits, Incentives/ benefits receivable from Government and cash & cash equivalents that derive directly from its operations.

The Company is exposed to -

- Market risk,
- Credit risk
- Liquidity risk

The Company's senior management oversees the management of these risks. The Board of Directors review and agreed policies for managing each of these risks, which are summarised below -

A Market risk

Market risk is the risk that the fair value of future cash flows of a financial instrument will fluctuate because of changes in market prices. Market risk mainly comprises of Interest rate risk and currency risk.

A.1 Interest rate risk

Interest rate risk is the risk that the fair value or future cash flows of a financial instrument will fluctuate because of changes in market interest rates. The Company's exposure to the risk of changes in market interest rates relates primarily to the Company's debt obligations with floating interest rates. The Company is exposed to interest rate risk primarily due to borrowings having floating interest rates given below:

Variable Rate Instruments	As at March 31, 2021 INR in Million	As at March 31, 2020 INR in Million	As at March 31, 2019 (Proforma) INR in Million
Term loan from banks - Non current (Note 12)	208.10	351.44	830.92
Term loan from banks - Current (Note 14)	335.74	207.84	595.03
Other short term borrowings (Note 12)	1835.72	1939.26	2343.25
<b>Total</b>	<b>2379.56</b>	<b>2498.54</b>	<b>3769.2</b>

Interest rate sensitivity analysis shown below with 1% that an increase / decrease in floating interest rates would result in decrease / increase in the Company's profit and equity by -

Particulars	Interest Rate Sensitivity (INR in Millions)					
	As at March 31, 2021		As at March 31, 2020		As at March 31, 2019 (Proforma)	
	Up Move	Down Move	Up Move	Down Move	Up Move	Down Move
Impact on Equity	23.80	(23.80)	24.99	(24.99)	37.69	(37.69)
Impact on P&L	23.80	(23.80)	24.99	(24.99)	37.69	(37.69)
<b>Total Impact</b>	<b>47.60</b>	<b>(47.60)</b>	<b>49.98</b>	<b>(49.98)</b>	<b>75.38</b>	<b>(75.38)</b>

#### A.2 Foreign currency risk

Foreign currency risk is the risk that the fair value or future cash flows of an exposure will fluctuate because of changes in foreign exchange rates.

Company's unhedged foreign currency exposure are described below -

Particulars of unhedged foreign currency exposure	Currency	As at March 31, 2021	As at March 31, 2020	As at March 31, 2019 (Proforma)
Trade receivables (Note 7)	USD	17.88	8.15	13.12
	EUR	4.23	2.56	4.75
	ZAR	0.96	1.20	1.07
	CAD	0.16	-	0.00
	Equivalent INR in million		1,687.60	829.69
Trade payables (Note 13)	USD	4.84	3.27	3.87
	EUR	0.004	0.01	0.01
	JPY	-	0.35	0.56
	Equivalent INR in million		354.93	247.44
Payables for capital goods (Note 14)	JPY	51.76	1.62	0.72
	Equivalent INR in million		34.39	1.13
Advance to suppliers (Note 9)	JPY	61.48	-	0.53
	USD	0.43	-	0.00
	Equivalent INR in million		72.36	-
Working capital facilities (Note 12.2)	USD	15.39	18.93	21.23
	EUR	3.28	2.73	5.12
	Equivalent INR in million		1,409.44	1,648.38



Foreign currency sensitivity analysis

The Company is mainly exposed to the currency : USD, EUR, JPY, ZAR and CAD.

The following table details, Company's sensitivity to a 5% increase and decrease in the rupee against the relevant foreign currencies. 5% is the sensitivity rate used when reporting foreign currency risk internally to key management personnel and represents management's assessment of the reasonably possible change in foreign exchange rates. This is mainly attributable to the exposure outstanding not hedged on receivables and payables in the Company at the end of the reporting period. The sensitivity analysis includes only outstanding foreign currency denominated monetary items and adjusts their translation at the period end for a 5% change in foreign currency rate. A positive number below indicates an increase in the profit and equity where the rupee weakening 5% against the relevant currency. For a 5% strengthen of the rupee against the relevant currency, there would be a comparable impact on the profit and equity, and the balances below would be negative.

Impact on profit or loss and total equity

Particulars	(Rs. in Million)		
	As at March 31, 2021	As at March 31, 2020	As at March 31, 2019 (Proforma)
Increase in exchange rate by 5%	177.94	136.33	173.02
Decrease in exchange rate by 5%	(177.94)	(136.33)	(173.02)

B Credit Risk

Credit risk is the risk that counterparty will not meet its obligations under a financial instrument or customer contract, leading to a financial loss. The Company is exposed to credit risk from its operating activities (primarily trade receivables) and from its financing activities, including deposits with banks and financial institutions, foreign exchange transactions and other financial instruments.

Trade receivables

Customer credit risk is managed by the Company's established policies, procedures and controls relating to customer credit risk management. Credit quality of a customer is assessed based on an individual credit limits and are defined in accordance with management's assessment of the customer. Outstanding customer receivables are regularly monitored. The concentration of credit risk is limited due to the fact that the customer base is large. An impairment analysis is performed at each reporting date using a provision matrix to measure expected credit loss. The Company uses ageing buckets and provision matrix for the purpose of computation of expected credit loss. The provision rates are based on past trend of recoverability. The calculation reflects the probability-weighted outcome, the time value of money and reasonable and supportable information that is available at the reporting date about past events, current conditions and forecasts of future economic conditions. The Company does not hold collateral as security.

C Liquidity risk

Liquidity risk is the risk the Company cannot meet its financial obligations. The objective of liquidity risk management is to maintain sufficient liquidity and to ensure that funds are available as per requirements. The company constantly generate cashflows from operation to meet its financial obligations when they fall due.

The table below summarises the maturity profile of the Company's financial liabilities based on contractual undiscounted payments.

	On demand	Next 1 year	1 to 5 years	> 5 years	Total
	INR in Million	INR in Million	INR in Million	INR in Million	INR in Million
Year ended March 31, 2021					
Term loan from banks (Note 12)	-	-	208.10	-	208.10
Non Convertible Preference Shares - Liability component of compound Financial instruments (Note 12)	-	-	100.59	-	100.59
Optionally Convertible Preference Share-Liability component of compound Financial Instruments(Note 12)	-	-	-	14.76	14.76
Lease Liabilities - Non current (Note 34)	-	-	-	0.67	0.67
Short term Borrowings (Note 12)	171.10	-	-	-	171.10
Short term Borrowings (Note 12)	-	1,664.62	-	-	1,664.62
Trade Payables (Note 13)	-	1,176.35	-	-	1,176.35
Current maturities of Borrowings - Non current (Note 14)	-	335.74	-	-	335.74
Employee dues (Note 14)	-	53.28	-	-	53.28
Lease Liabilities - Current (Note 34)	-	0.39	-	-	0.39
Payables for capital goods (Note 14)	-	44.95	-	-	44.95
	171.10	3,275.33	308.69	15.43	3,770.56

Rolex Rings Limited (formerly known as Rolex Rings Private Limited)  
 (All amount in Indian rupees million, unless otherwise stated)  
 Annexure VII  
 Notes to Restated Ind AS Summary Statements

The table below summarises the maturity profile of the Company's financial liabilities based on contractual undiscounted payments.

	On demand	Less than 1 year	1 to 5 years	> 5 years	Total
	INR in Million	INR in Million	INR in Million	INR in Million	INR in Million
Year ended March 31, 2020					
Term loan from banks (Note 12)	-	-	351.44	-	351.44
Non Convertible Preference Shares - Liability component of compound Financial instruments (Note 12)	-	-	90.99	-	90.99
Lease Liabilities - Non current (Note 34)	-	-	-	0.94	0.94
Short term Borrowings (Note 12)	190.83	-	-	-	190.83
Short term Borrowings (Note 12)	-	1,748.43	-	-	1,748.43
Trade Payables (Note 13)	-	738.47	-	-	738.47
Current maturities of Borrowings - Non current (Note 14)	-	207.84	-	-	207.84
Employee dues (Note 14)	-	44.47	-	-	44.47
Lease Liabilities - Current (Note 34)	-	0.39	-	-	0.39
Payables for capital goods (Note 14)	-	7.57	-	-	7.57
	190.83	2,747.17	442.43	0.94	3,381.37
Year ended March 31, 2019 (Proforma)					
	On demand	Less than 1 year	1 to 5 years	> 5 years	Total
	INR in Million	INR in Million	INR in Million	INR in Million	INR in Million
Term loan from banks (Note 12)	-	-	830.92	-	830.92
Non Convertible Preference Shares - Liability component of compound Financial instruments (Note 12)	-	-	52.45	30.03	82.48
Lease Liabilities - Non current (Note 34)	-	-	-	1.18	1.18
Short term Borrowings (Note 12)	301.13	-	-	-	301.13
Short term Borrowings (Note 12)	-	2,042.12	-	-	2,042.12
Trade Payables (Note 13)	-	912.99	-	-	912.99
Current maturities of Borrowings - Non current (Note 14)	-	595.03	-	-	595.03
Employee dues (Note 14)	-	43.88	-	-	43.88
Lease Liabilities - Current (Note 34)	-	0.39	-	-	0.39
Payables for capital goods (Note 14)	-	6.74	-	-	6.74
	301.13	3,601.15	883.37	31.21	4,816.86

### 37 Capital management

The Company aims to manages its capital efficiently so as to safeguard its ability to continue as a going concern and to optimise returns to its shareholders.

The capital structure of the Company is based on management's judgement of the appropriate balance of key elements in order to meet its strategic and day-to-day needs. The Company considers the amount of capital in proportion to risk and manage the capital structure in light of changes in economic conditions and the risk characteristics of the underlying assets. In order to maintain or adjust the capital structure, the Company may adjust return on capital to shareholders or issue new shares.

The Company's policy is to maintain a stable and strong capital structure with a focus on total equity so as to maintain investor, creditors and market confidence and to sustain future development and growth of its business. The Company will take appropriate steps in order to maintain, or if necessary adjust, its capital structure.

The Company monitors capital using a gearing ratio, which is net debt divided by total capital plus net debt. Net debt is calculated as loans and borrowing less cash and cash equivalents

Particulars	As at March 31, 2021	As at March 31, 2020	As at March 31, 2019 (Proforma)
	INR in Million	INR in Million	INR in Million
Loan repayable on demand from banks (Note 12)	1,835.72	1,939.26	2,343.25
Long term loans from banks (Note 12)	208.10	351.44	830.92
Liability portion of Non Convertible Redeemable Preference Shares (Note 12)	100.59	90.99	82.48
Liability portion of Optionally Convertible Redeemable Preference Shares (Note 12)	14.76	-	-
Current maturities of Borrowings - Non current (Note 14)	335.74	207.84	595.03
Less - Cash and cash equivalent (Note 8)	46.12	12.45	1.38
Net debt (A)*	2,448.79	2,577.08	3,850.30
Equity** (Note 10 and 11)	3,567.33	2,681.05	2,153.44
Net Equity (B)	3,567.33	2,681.05	2,153.44
Capital gearing ratio (A/B)	0.69	0.95	1.79

\* Debt is defined as long-term borrowings, short-term borrowings and current maturities of long term borrowings.

\*\*Equity includes Share capital, reserves and surplus, Other comprehensive income and equity component of compound financial instrument.

In order to achieve this overall objective, the Company's capital management, amongst other things, aims to ensure that it meets financial covenants attached to the interest-bearing loans and borrowings that define capital structure requirements. Breaches in meeting the financial covenants would permit the bank to immediately call loans and borrowings. There have been no breaches in the financial covenants of any interest-bearing loans and borrowing in the current period.

Annexure VII  
Notes to Restated Ind AS Summary Statements

38 First time adoption

A. First-time adoption

The Restated Ind AS Summary Statements for the year ended March 31, 2019 have been prepared on Proforma basis in accordance with requirements of SEBI Circular dated March 31, 2016 and Guidance Note on Reports in Company Prospectus issued by ICAI. For the purpose of Proforma Restated Ind AS Summary Statements for the year ended March 31, 2019, the Company has followed the same accounting policy and accounting policy choices (both mandatory exceptions and optional exemptions availed as per Ind AS 101) as initially adopted on the transition date i.e. April 1, 2017. In preparing these proforma financial statements, the Company has prepared opening Balance Sheet as at April 1, 2017, being Proforma date of transition to Ind AS.

Ind AS 101 allows first time adopters certain exemptions and certain optional exceptions from the retrospective application of certain requirements under Ind AS as follows:

B. Exemptions applied

(a) Deemed Cost

Ind AS 101 permits a first time adopter to elect to continue with the carrying value for all of its property, plant and equipment as recognised in the financial statements as at the date of transition after making necessary adjustments for de-commissioning liabilities. This exemption can also be used for intangible assets covered by Ind AS 38. Accordingly the Company has elected to measure all of its property, plant and equipment and intangible assets at their Previous GAAP carrying values.

(b) Designation of previously recognised financial instruments

Financial assets and financial liabilities are classified at fair value through profit or loss based on facts and circumstances as at the date of transition to Ind AS. Financial assets and liabilities are recognised at fair value as at the date of transition to Ind AS i.e. April 01, 2019 (April 01, 2017 proforma transition date) and not from the date of initial recognition.

C. Mandatory Exceptions

(a) Estimates

The estimates as at April 01, 2019 (April 01, 2017 proforma transition date) and March 31, 2019 (Proforma) are consistent with those made for the same dates in accordance with Indian GAAP except impairment of financial assets based on expected credit loss model. The estimates used by the Company to present these amounts in accordance with Ind AS reflect conditions at April 01, 2019 (April 01, 2017 proforma transition date), the date of transition to Ind AS and as of March 31, 2019.

(b) Classification and measurement of financial assets

Ind AS 101 requires an entity to assess classification and measurement of financial assets (investment in debt instruments) on the basis of the facts and circumstances that exist at the date of transition to Ind AS.

(c) Derecognition of financial assets and financial liabilities

As set out in Ind AS 101, the Company has applied the derecognition requirements of Ind AS 109 prospectively for transactions appearing on or after the date of transition to Ind AS.

(d) Impairment of financial assets

The Company has applied exception related to impairment of financial assets given in Ind AS 101. It has used reasonable and supportable information that is available without undue cost or effort to determine the credit risk at the date that financial assets were initially recognised and compared that to the credit risk at April 01, 2019 (April 01, 2017 proforma transition date).

Annexure VII  
Notes to Restated Ind AS Summary Statements

D Statement of reconciliation of total equity and profit and loss as per previous GAAP and Ind AS

Reconciliation of total equity as at March 31, 2020, March 31, 2019 (Proforma) and April 01, 2018 (Proforma).

Equity reconciliation				(INR in Millions)
Particulars	Notes to first time adoption	March 31, 2020	March 31, 2019 (Proforma)	April 01, 2018 (Proforma)
Total equity as per previous GAAP (A)		2,788.69	2,255.38	1,638.84
Impact on account of compound financial instrument	a	(90.99)	(82.48)	(74.79)
Impact on account of application of Ind AS 116 (net)	b	(0.68)	(0.74)	(0.79)
Impact of above adjustments on deferred taxes	c	(15.97)	(18.72)	-
<b>Total Ind AS adjustments (B)</b>		<b>(107.64)</b>	<b>(101.94)</b>	<b>(75.58)</b>
<b>Total Equity as per Ind AS (C = A + B)</b>		<b>2,681.05</b>	<b>2,153.44</b>	<b>1,563.26</b>
<b>Total Restated Equity</b>		<b>2,681.05</b>	<b>2,153.44</b>	<b>1,563.26</b>

Reconciliation of total comprehensive income for the year ended March 31, 2020 and March 31, 2019 (Proforma)

Profit reconciliation				(INR in Millions)
Particulars	Notes to first time adoption	March 31, 2020	March 31, 2019 (Proforma)	
Net profit after tax under Previous GAAP		533.31	616.54	
Impact on account of compound financial instrument	a	(8.51)	(7.69)	
Impact on account of application of Ind AS 116 (net)	b	0.06	0.05	
Others	d	2.77	0.35	
Impact of above adjustments on deferred taxes	c	1.78	(18.84)	
<b>Total Ind AS adjustments (b)</b>		<b>(3.90)</b>	<b>(26.13)</b>	
Net profit for the year		529.41	590.41	
Other comprehensive income (net of tax)	d, e	(1.80)	(0.23)	
<b>Total Comprehensive Income as per Ind AS</b>		<b>527.61</b>	<b>590.18</b>	

E. Notes to first time adoption

(a) Accounting of compound financial instrument

Pursuant to Ind AS 32, Non Convertible Redeemable Preference Shares issued by the Company is split into equity and liability components and presented accordingly. The measurement of liability component is done at fair value at the inception and subsequently at amortised cost. Under I-GAAP Non Redeemable preference shares were accounted at cost and presented as part of Share Capital.

(b) Leases

Under Previous GAAP, lease rentals were recognised as an expense after giving straight lining impact. Under Ind AS 116, the lessee shall recognise right of use assets and lease liabilities at the inception of lease. Right of use asset is being depreciated over the lease period and lease liability is classified as financial liability and finance cost is charged on it for each reporting period. The above calculated amount is cumulative of depreciation on right-of-use assets, finance cost element and reversal of lease rent expenses.

(c) Deferred tax

The transitional adjustments have led to temporary differences and accordingly, the Company has accounted for such differences. Deferred tax adjustments are recognised in correlation to the underlying transaction either in retained earnings or a separate component of equity.

(d) Actuarial loss transferred to Other Comprehensive Income

Under Ind AS, remeasurements i.e. actuarial gains and losses and the return on plan assets, excluding amounts included in the net interest expense on the net defined benefit liability are recognised in other comprehensive income instead of Restated Statement of Profit and Loss. As a result of this change, profit for the year ended March 31, 2019 (Proforma) and March 31, 2020 has decreased by Rs. 0.23 million and Rs. 1.80 million respectively. There is no impact on total equity.

(e) Other comprehensive income

Under Ind AS, all items of income and expense recognised in a period should be included in profit or loss for the year unless standard requires or permits otherwise. Items of income and expense that are not recognised in profit and loss but are shown in the Restated Statement of Profit and Loss as 'other comprehensive income' includes remeasurements of defined benefit plans. The concept of other comprehensive income did not exist under the Previous GAAP.

Rolex Rings Limited (formerly known as Rolex Rings Private Limited)  
 CIN: U28910GJ2003PLC041991  
 (All amount in Indian rupees million, unless otherwise stated)

Annexure VII  
 Notes to Restated Ind AS Summary Statements

(F) Statement of Cash flows

Impact of above Ind AS adjustments in the statement of cash flows for the year ended March 31, 2020 is as follows.

Cash flow reconciliation for the year ended March 31, 2020			
Particulars	(INR in Millions)		
	Indian GAAP	Adjustments	Ind AS
Net cash flow from operating activities	1,837.38	0.39	1,837.77
Net cash flow from investing activities	(141.70)	-	(141.70)
Net cash flow from financing activities	(1,684.61)	(0.39)	(1,685.00)
Net increase in cash and cash equivalents	11.07	-	11.07
Cash and cash equivalents at the beginning of the year	1.38	-	1.38
Cash and cash equivalents at the end of the year	12.45	-	12.45

Impact of above Ind AS adjustments in the statement of cash flows for the year ended March 31, 2019 (Proforma) is as follows.

Cash flow reconciliation for the year ended March 31, 2019 (Proforma)			
Particulars	(INR in Millions)		
	Indian GAAP	Adjustments	Ind AS
Net cash flow from operating activities	1,937.66	0.39	1,938.05
Net cash flow from investing activities	(363.49)	-	(363.49)
Net cash flow from financing activities	(1,579.73)	(0.39)	(1,580.12)
Net increase in cash and cash equivalents	(5.56)	-	(5.56)
Cash and cash equivalents at the beginning of the year	6.94	-	6.94
Cash and cash equivalents at the end of the year	1.38	-	1.38

Annexure VII  
Notes to Restated Ind AS Summary Statements

39 The COVID-19 pandemic has disrupted various business operations due to lockdown and other emergency measures imposed by the government. The operations of the Company were impacted briefly, due to shutdown of factory following nationwide lockdown. The Company continues with its operations in line with directives from the authorities.

The company has made detailed assessment of its liquidity positions and business operations for next year and its possible effect on the carrying value of assets. The Company does not expect significant impact on its operations and recoverability of value of its assets based on current indicators of future economic conditions. However, the impact assessment of COVID-19 is a continuing process given the uncertainties associated with its nature and duration and accordingly the impact may be different from that estimated as at the date of approval of these financial statements. The company will continue to monitor any material changes to future economic condition and its impact, if any.

40 Government of India's Code for Social Security 2020 (the 'Code') received assent from the President in September 2020. However, the date from when the Code will become applicable and the Rules have not yet been notified. The Company will assess the impact of the Code and account for the same once the effective date and the rules are notified.

41 Pursuant to the meeting of Board of Directors held on March 03, 2021, the company issued to the subscribers 9 optionally convertible redeemable preference shares ('OCRPS') of Rs. 10/- each at zero coupon rate for every 44 (Forty Four) Equity shares held by them. Consequently 26,30,000 OCRPS have been issued. As per the terms of the issue, the holder of OCRPS will have an option to convert the same into equity shares at a face value of Rs. 10/- each if the Company opts for the Initial Public Offer (IPO) in future, then the said OCRPS will be optionally converted in to Equity Shares after filing of Draft Red Herring Prospectus but before filing of Red Herring Prospectus. Further the said preference shares will not be entitled for any dividend during the currency of tenure. Subsequent to year end the company has opted to go for the IPO, the holder have exercise the option of conversion. Accordingly 26,30,000 equity shares are issued on July 16, 2021.

42 The opening balances as at April 01, 2017 considered for the purpose of proforma financial statement are based on audited financial statements as at March 31, 2017 prepared in accordance with the Indian GAAP, audited by firm of chartered accountants other than SRBC & CO. LLP and restated for differences on conversion from then existing Indian GAAP to Ind AS.

43 No significant subsequent events have been observed till date of these financial statements which may require any additional disclosure or an adjustment to the Restated Ind Summary Statement.

As per our report of even date.

For S R B C & CO LLP  
Chartered Accountants  
ICAI Firm Registration Number: 324982E/E300003

For and on behalf of the Board of Directors of  
Rolex Rings Limited (formerly known as Rolex Rings Private Limited)  
CIN: U28910GJ2003PLC041991

per Sukrut Mehta  
Partner  
Membership number: 101974

Manesh Madeka  
Director  
DIN: 01629788

Bhautik Madeka  
Director  
DIN: 01761543

CS Hardik Gandhi  
Company Secretary  
Hiren Doshi  
Chief financial officer

Place: Ahmedabad  
Date: July 18, 2021

Place: Rajkot  
Date: July 18, 2021

Place: Rajkot  
Date: July 18, 2021

Place: Rajkot  
Date: July 18, 2021

Place: Rajkot  
Date: July 18, 2021



## OTHER FINANCIAL INFORMATION

The audited financial statements of our Company as at and for the year ended March 31, 2021, March 31, 2020, and March 31, 2019 (**Audited Financial Statements**) are available at [www.rolexrings.com](http://www.rolexrings.com). Our Company is providing a link to this website solely to comply with the requirements specified in the SEBI ICDR Regulations. The Audited Financial Statements and the reports thereon dated July 18, 2021, November 12, 2020 and September 30, 2019, respectively do not constitute, (i) a part of this Prospectus; or (ii) a prospectus, a statement in lieu of a prospectus, an offering circular, an offering memorandum, an advertisement, an offer or a solicitation of any offer or an offer document to purchase or sell any securities under the Companies Act, 2013, the SEBI ICDR Regulations, or any other applicable law in India or elsewhere in the world. The Audited Financial Statements, and the reports thereon, should not be considered as part of information that any investor should consider to subscribe for or purchase any securities of our Company, or any entity in which it or its shareholders have significant influence (collectively, the “**Group**”) and should not be relied upon or used as a basis for any investment decision. None of the Group or any of its advisors, nor any BRLMs or the Selling Shareholder, nor any of their respective employees, directors, affiliates, agents or representatives accept any liability whatsoever for any loss, direct or indirect, arising from any information presented or contained in the Audited Financial Statements, or the opinions expressed therein.

### Non-GAAP Measures

Certain non-GAAP measures like EBITDA, EBITDA margin, net worth, return on net worth, Net Asset Value per Equity Share, debt equity ratio and total borrowings to total equity (“**Non-GAAP Measures**”) presented in this Prospectus are a supplemental measure of our performance and liquidity that are not required by, or presented in accordance with, Ind AS, Indian GAAP, or IFRS. Further, these Non-GAAP Measures are not a measurement of our financial performance or liquidity under Ind AS, Indian GAAP, or IFRS and should not be considered in isolation or construed as an alternative to cash flows, profit/ (loss) for the year or any other measure of financial performance or as an indicator of our operating performance, liquidity, profitability or cash flows generated by operating, investing or financing activities derived in accordance with Ind AS, Indian GAAP, or IFRS. In addition, these Non-GAAP Measures are not a standardised term, hence a direct comparison of similarly titled Non-GAAP Measures between companies may not be possible. Other companies may calculate the Non-GAAP Measures differently from us, limiting its usefulness as a comparative measure. Although the Non-GAAP Measures are not a measure of performance calculated in accordance with applicable accounting standards, our Company’s management believes that it is useful to an investor in evaluating us because it is a widely used measure to evaluate a company’s operating performance. See “*Risk Factors - Certain non-GAAP financial measures and certain other statistical information relating to our operations and financial performance like EBITDA have been included in this Prospectus. These non-GAAP financial measures are not measures of operating performance or liquidity defined by Ind AS and may not be comparable.*” on page 41.

### Reconciliation of restated profit for the year to EBITDA and EBITDA margin for the year

The table below reconciles restated profit for the year to EBITDA. EBITDA is calculated as restated profit for the year plus total tax expenses, depreciation and amortization expenses, and finance costs while EBITDA Margin is the percentage of EBITDA divided by total income.

*(in ₹ million, except stated otherwise)*

Particulars	Year ended March 31,		
	2021	2020	2019 (Proforma)
<b>Restated profit for the year (I)</b>	<b>869.55</b>	<b>529.41</b>	<b>590.41</b>
<b>Adjustments:</b>			
Add: Total tax expenses (II)	(117.70)	191.42	815.19
Add: Finance costs (III)	116.99	321.69	420.19
Add: Depreciation and amortisation expense (IV)	254.09	265.24	254.40
<b>Earnings Before Interest, Tax, Depreciation and Amortisation (EBITDA) (V = I + II + III + IV)</b>	<b>1,122.93</b>	<b>1,307.76</b>	<b>2,080.19</b>
<b>Total Income (VI)</b>	<b>6,197.57</b>	<b>6,753.32</b>	<b>9,112.54</b>
<b>EBITDA Margin (VII=V/VI)</b>	<b>18.12%</b>	<b>19.36%</b>	<b>22.83%</b>

**Reconciliation of net worth***(in ₹ million)*

Particulars	Year ended March 31,		
	2021	2020	2019 (Proforma)
Equity share capital (I)	239.81	239.81	239.81
Other equity* (II)	3,327.52	2,441.24	1,913.63
<b>Net worth (III) = (I + II)</b>	<b>3,567.33</b>	<b>2,681.05</b>	<b>2,153.44</b>

\* includes equity component of compound financial instruments

**Reconciliation of return on net worth***(in ₹ million, except stated otherwise)*

Particulars	Year ended March 31,		
	2021	2020	2019 (Proforma)
Equity share capital (I)	239.81	239.81	239.81
Other equity* (II)	3,327.52	2,441.24	1,913.63
Total equity (III) = (I + II)	3,567.33	2,681.05	2,153.44
Restated profit for the year (IV)	869.55	529.41	590.41
<b>Return on net worth (V) = (IV / (III))</b>	<b>24.38%</b>	<b>19.75%</b>	<b>27.42%</b>

\* includes equity component of compound financial instruments;

**Reconciliation of Net Asset Value (per Equity Share)***(in ₹ million, except stated otherwise)*

Particulars	Year ended March 31,		
	2021	2020	2019 (Proforma)
Equity share capital (I)	239.81	239.81	239.81
Other equity* (II)	3,327.52	2,441.24	1,913.63
Total equity (III) = (I + II)	3,567.33	2,681.05	2,153.44
Number of equity shares (IV)	2,39,81,090	2,39,81,090	2,39,81,090
<b>Net asset value per equity share (V) = (III / IV) (in ₹)</b>	<b>148.76</b>	<b>111.80</b>	<b>89.80</b>

\* includes equity component of compound financial instruments

**Reconciliation of debt equity ratio***(in ₹ million except ratio)*

Particulars	Year ended March 31,		
	2021	2020	2019 (Proforma)
Non-current borrowings* (I)	323.45	442.43	913.40
Current maturity of long-term debts (II)	335.74	207.84	595.03
Short term borrowings (III)	1,835.72	1,939.26	2,343.25
Total borrowings (IV = I + II + III)	2,494.91	2,589.53	3,851.68
Equity share capital (V)	239.81	239.81	239.81
Other equity** (VI)	3,327.52	2,441.24	1,913.63
Total equity (VII) = (V + VI)	3,567.33	2,681.05	2,153.44
<b>Debt equity ratio (VIII = IV / VII)</b>	<b>0.70</b>	<b>0.97</b>	<b>1.79</b>

\* includes liability component of compound financial instruments.

\*\*includes equity component of compound financial instruments.

## MANAGEMENT'S DISCUSSION AND ANALYSIS OF FINANCIAL CONDITION AND RESULTS OF OPERATIONS

*The following discussion and analysis of our Company's financial condition and results of operations, and our assessment of the factors that may affect our prospects and performance in future periods is based on, and should be read in conjunction with, our Restated Financial Statements as of and for the years ended March 31, 2019, 2020 and 2021, including the annexures, notes and significant accounting policies thereto, included in the section titled "Financial Information" beginning on page 161.*

*Our fiscal year ends on March 31 of each year, so all references to a particular "Fiscal" are to the 12-month period ended March 31 of that fiscal year.*

*This discussion and analysis contains forward-looking statements that reflect our current views with respect to future events and our financial performance, which are subject to numerous risks and uncertainties. Our actual results may differ materially from those anticipated in these forward-looking statements. As such, you should also read "Risk Factors" and "Forward Looking Statements" beginning on pages 22 and 14, respectively, which discusses a number of factors and contingencies that could affect our financial condition and results of operations and cash flows. This section also includes industry data, which has been derived and sourced from the report titled "Indian Bearings Industry – Industry revenue to witness a smart recovery in FY 2022" as prepared by ICRA Limited, which was commissioned by our Company.*

### OVERVIEW

We are one of the top five forging companies in India in terms of installed capacity (*Source: ICRA Report*) and a manufacturer and global supplier of hot rolled forged and machined bearing rings, and automotive components for segments of vehicles including two-wheelers, passenger vehicles, commercial vehicles, off-highway vehicles, electric vehicles), industrial machinery, wind turbines and railways, amongst other segments. We supply domestically and internationally to large marquee customers including some of the leading bearing manufacturing companies, tier-I suppliers to global auto companies and some auto OEMs. As per ICRA Report, SKF India Limited, Schaeffler India Limited Timken India Limited, NEI and NRB collectively account for 81% of the market share of Indian bearing industry. We are one of the key manufacturers of bearing rings in India (*Source: ICRA Report*) and cater to most of the leading bearing companies in India.

We started our manufacturing operations in 1988 with our first manufacturing plant set up in Rajkot. As on date of this RHP, we have three manufacturing units in Rajkot. Our manufacturing infrastructure includes high-speed hot formers from Sakamura (such as Sakamura model HBP-160, Sakamura Model HBP – 120SS and Sakamura Model: HFW-1000-4 Hot Former) and Hatebur (such as Hatebur Hotmatic – HM75XL Hot Former and Hatebur-Hotmatic@ HM 35 Machine) and vertical forging lines from Manyo (Manyo 600 tons Auto Forging Press), Mistubishi, SMS Meer (such as SMS MEER Ring Rolling line), Enomoto (such as Enomoto Model 1000ZESH and Servomoto Driven Screw Press 16000kN), Eumoco and conventional forging lines integrated with induction heating furnaces. A large part of our existing machining lines consists of spindles from DMG, FUJI, ACE, TSUGAMI, Hyundai, Mazak, Muratec and domestic CNC Turning centres as well. As on date of this RHP, we have 22 forging lines with a combined installed capacity of 1,44,750 MTPA, machining facilities consisting of 528 spindles with a combined installed capacity of 69 million parts per annum and other machinery including heat treatment furnaces, cold rolling machines and other infrastructure.

Our product portfolio includes a wide range of bearing rings, parts of gear box and automotive components, among others. Our manufacturing capabilities are complemented by our tool design, engineering and product development capabilities. Till date, we have offered a diverse range of hot forged and machined alloy steel bearing rings weighing from 0.01 kilograms to over 163 kilograms, and with inner diameter of 25 millimeters to outer diameter of 900 millimeters. This makes our products suitable for a wide range of end-user industries such as automotive, railways, industrial infrastructure, renewable energy, among others.

Our customers typically order in large volumes, and we cater to their orders by using our flexible manufacturing infrastructure, skills and processes to achieve operational efficiency and quality. For Fiscal 2021, we supplied bearing rings and automotive components to over 60 customers in 17 countries, primarily located in India, United States of America and in European countries such as Germany, France, Italy, and Czech Republic, and Thailand. We have been able to maintain long standing relations with our customers and 70% of our 10 largest customers for Fiscal 2021 have been with us for over a decade.

In the past, we have received awards from our customers in relation to our products, such as ‘Supplier Quality Excellence Award’ from General Motors in 2018 and 2019 and ‘Excellence in New Product Development’ from Timken in 2018. We have also received various certifications, demonstrating our dedication and commitment to quality and service excellence. Further, our Company is in the process of renewing its IATF 16949 (International Standard for Automotive Quality Management Systems) and ISO 9001 (International Standard for Quality Management Systems) certifications which pertains to quality management systems and such renewal has been recommended by TUV NORD - Germany. Our Company has recently also received ‘Q1 Preferred Quality Status’ award in May 2021 from Ford.

We intend to de-risk our business’ dependence on changes in power tariffs and reduce our carbon footprint through investment in renewable energy. As on date, the Company operates windmills with installed capacity of 8.75 MW. We are in the process of expanding capacity of our solar projects by an installed capacity of 16 MW and have already placed purchase orders for equipment with installed capacity of 7.35 MW. We believe that the proposed expansion will help us in reducing our carbon footprint and expanding our profit margins.

Our revenue from operations for Fiscal 2021, 2020 and 2019 ₹ 6,163.32 million, ₹ 6,659.94 million, and ₹ 9,043.23 million respectively and EBITDA margin were 18.12%, 19.36%, and 22.83%, respectively for the corresponding period. For Fiscal 2021, 2020 and 2019, our revenue from operations from outside India as a percentage of revenue from operations were 56.12%, 53.82%, and 56.27%, respectively. Further, our revenue from sale of products can be attributable to the following sources:

S. No	Source of revenue	Fiscal		
		2021	2020	2019
1.	Bearing rings	3,309.65	3,498.15	5,345.34
2.	Auto components	2,373.65	2,660.78	2,944.13

(₹ in million)

## SIGNIFICANT FACTORS AFFECTING RESULTS OF OUR OPERATIONS

Our results of operations and financial condition are subject to various risks and uncertainties, including those discussed in “*Risk Factors*” on page 22. Certain important factors which we expect to continue to affect our results of operations, financial conditions, and cash flows include the following:

### *Client relationships*

We significantly rely on a limited set of customers, we may face certain issues including pricing pressures. Further, the revenue from these customers may vary from year to year, making it difficult to forecast future business needs and the loss or significant decrease in the volume of business from one or more of our significant customers would have an adverse effect on our business, financial condition and cash flows. Any significant decreases in spending in the sectors our customers operate in, may accordingly reduce the demand for our bearing rings and auto-component products and adversely affect our business, financial condition and results of operations. We may further be subject to counterparty credit risk and any delay in receiving payments or non-receipt of payments may adversely impact our results of operations. Further, our customers impose significant requirements on us including stringent quality requirements and delivery schedules. For instance, in the past we have been required to resort to significantly costlier modes of transportation to meet our delivery commitments and scrap materials which do not comply with the quality parameters set by our customers. Our inability to manage such requirements may have an adverse impact of our ability to retain such customers, our reputation and results from operations.

### *Operating costs, efficiencies and raw material costs*

Given the nature of our business, our ability to manage our operating costs and efficiencies is critical to maintaining our competitiveness and profitability. Our profitability is partially dependent on our ability to spread fixed production costs over higher production volumes. We continually undertake efforts to reduce our costs in order to protect our margins, including through process optimization, outsourcing noncritical processes and reducing energy usage. Our ability to reduce our operating costs in line with customer demand is subject to risks and uncertainties, as our costs depend, in part, on external factors beyond our control.

### *Capacity utilization and capacity expansion*

Our capacity utilization is dependent upon our ability to optimally manage our manufacturing facilities, which are subject to various operating risks, including those beyond our control, such as the breakdown and failure of equipment or industrial accidents, severe weather conditions and natural disasters. For instance, our capacity

utilization for forging was 33.48%, 32.92%, and 50.01%, for Fiscal 2021, 2020, and 2019, respectively. Any significant malfunction or breakdown of our machinery may entail repair and maintenance costs and cause delays in our operations. If we are unable to repair malfunctioning machinery in a timely manner or at all, our facilities may not be able to operate at desired utilization levels or our operations may be suspended until we procure machinery to replace the same.

### ***Foreign exchange fluctuation***

Most of our sales to our overseas customers are denominated in foreign currencies, predominantly USD and Euro. We export our products to customers in 16 countries primarily located in United States of America and in European countries such as Germany, France, Italy, and Czech Republic, and Thailand. For Fiscal 2021, 2020 and 2019, 56.12%, 53.82% and 56.27% respectively of our revenue from operations were from outside India. Further, we import a part of our cost of raw materials and components consumed. As on March 31, 2021, approximately 76.78% of our working capital facilities are in foreign currency. Our results of operations are therefore, significantly impacted by exchange rate fluctuations.

For details in relation to the exchange rate as on March 31, 2021, March 31, 2020, and March 31, 2019, please see “*Certain Conventions, Use of Financial Information and Market Data and Currency Of Presentation – Exchange Rates*” on page 11.

### ***Competition***

Competition in our business is based on relationships with customers, product quality, pricing, infrastructure and customisation. We may face price pressures from our customers who aim to produce their products at competitive costs and consequently, source products manufactured by us at cheaper prices. We are unable to assure you that we shall be able to meet the pricing pressures imposed by such customers which would adversely affect our profitability. Additionally, some of our competitors may have greater financial, research and technological resources, larger sales and marketing teams and more established reputation. They may also be in a better position to identify market trends, adapt to changes in industry, innovate new products, offer competitive prices due to economies of scale and also ensure product quality and compliance, among others, which may adversely affect our business and financial condition.

### ***Government regulations and policies***

We require certain statutory and regulatory permits, licenses, registrations and approvals to operate our business such as consents to establish and operate from the state pollution control boards, registration and licenses issued under the Factories Act, fire safety licenses from municipal fire safety authorities, registration certificates issued under various labour laws, including contract labour registration certificates and licenses as well as various taxation related registrations, such as registrations for payment of goods and service tax and professional taxes. Our licenses, permits and approvals impose certain terms and conditions that require us to incur significant costs and inter alia, restrict certain activities. Further, many of these approvals require renewal from time to time and in the past, we have been unable to procure some of these approvals within stipulated timelines. Changes in laws and regulations, more stringent enforcement or alternative interpretation of existing laws and regulations in geographies in which we currently operate may make compliance with all applicable laws and regulations more challenging and could affect us adversely by tightening restrictions, reducing our freedom to do business, increasing our costs of doing business, or reducing our profitability.

### ***Impact of COVID-19 pandemic***

On account of the COVID-19 pandemic, the Government of India had announced a nation-wide lockdown on March 24, 2020 and imposed several restrictions. Subsequently and within a period of 1.5 months, our operations were determined to be part of an essential industry, and we were allowed to resume operations in a phased manner, subject to certain adjustments in working patterns and limited workforce. The pandemic and steps taken to counter the pandemic caused an economic downturn, reduced consumer spending, as well as significant market disruption and volatility in India and globally. The demand for our products is dependent on and directly affected by factors affecting industries where our products are used. In view of the fluidity of the situation and lack of visibility on the timeline for containment of the global pandemic, the recovery trajectory in our end user industries remains uncertain. It is difficult for us to predict the impact that COVID-19 will have on us, our customers or suppliers in the future and we continue to closely monitor the impact that COVID-19 may have on our business and results of operations. However, the Company has made detailed assessment of its liquidity positions and business operations

its possible effect on the carrying value of assets. However, the impact assessment of COVID-19 is a continuing process given the uncertainties associated with its nature and duration and accordingly the impact may be different from that estimated as at the date of approval of these financial statements. The Company will continue to monitor any material changes to future economic condition and its impact, if any.

*[Rest of the page intentionally left blank]*

## SIGNIFICANT ACCOUNTING POLICIES

Our Restated Financial Statements comprise the financial statements of our Company (as defined below), as of and for the financial years 2021, 2020, and 2019.

### 1 Significant accounting policies

#### i) Basis of preparation of financial statements

The Restated Ind AS Summary Statements of the Company comprise of the Restated Ind AS Summary Statement of Assets and Liabilities as at March 31, 2021, March 31, 2020, March 31, 2019 (Proforma), the related Restated Ind AS Summary Statement of Profit and Loss (including Other Comprehensive Income), the Restated Ind AS Summary Statement of Cash Flows and the Restated Ind AS Summary Statement of Changes in Equity for the years ended March 31, 2021, March 31, 2020, and March 31, 2019 (Proforma), and the Significant Accounting Policies and explanatory notes (collectively, the 'Restated Ind AS Summary Statements' or 'Statements').

These Statements have been prepared by the Management for the purpose of preparation of the restated financial statements as required under the Securities and Exchange Board of India (Issue of Capital and Disclosure Requirements) Regulations, 2018, as amended from time to time, issued by the Securities and Exchange Board of India ('SEBI') on 11 September 2018, in pursuance of the Securities and Exchange Board of India Act, 1992 ("ICDR Regulations") for the purpose of inclusion in the Red Herring Prospectus ('RHP') in connection with its proposed initial public offering of equity shares of face value of Rs. 10 each of the Company comprising a fresh issue of equity shares and an offer for sale of equity shares held by the selling shareholders (the "Offer"), prepared by the Company in terms of the requirements of:

- (a) Section 26 of Part I of Chapter III of the Companies Act, 2013 (the "Act");
- (b) The Securities and Exchange Board of India (Issue of Capital and Disclosure Requirements) Regulations, 2018 as amended from time to time; and
- (c) The Guidance Note on Reports in Company Prospectuses (Revised 2019) issued by the Institute of Chartered Accountants of India (ICAI) (the "Guidance Note"). The Restated Ind AS Summary Statements have been compiled from:
  - Audited Ind AS financial statements of the Company as at and for the year ended March 31, 2021 prepared in accordance with the Indian Accounting Standard (referred to as "Ind AS") as prescribed under Section 133 of the Act read with Companies (Indian Accounting Standards) Rules 2015, as amended and other accounting principles generally accepted in India, which have been approved by the Board of Directors at their meeting held on July 18, 2021. The financial statements for the year ended March 31, 2021 are the first financial statements that the company has prepared in accordance with Ind AS. The date of transition is April 1, 2019. The transition to Ind AS has been carried out from the accounting standards notified under section 133 of the Act read with Companies (Accounts) Rules, 2014 (as amended), which is considered as the previous GAAP for the purpose of Ind AS 101.
  - Audited financial statements of the Company as at and for year ended March 31, 2020 prepared in accordance with accounting principles generally accepted in India ("Indian GAAP") including the Companies (Accounting Standards) Rules, 2006 (as amended) specified under Section 133 of the Act read with Companies (Accounts) Rules 2014 (as amended), which have been approved by the Board of Directors at their meeting held on November 12, 2020. The Restated Ind AS Summary Statements also includes Ind AS Summary Statements for the year ended March 31, 2020 which have been prepared from the audited financial statements of the Company as at and for the year ended March 31, 2020; have been adjusted to make them compliant with recognition and measurement under Ind-AS, and has included such adjusted financial information as comparative financial information in the financial statements for the year ended March 31, 2021.

- Audited financial statements of the Company as at and for the year ended March 31, 2019, which were prepared in accordance with accounting principles generally accepted in India (“Indian GAAP”) including the Companies (Accounting Standards) Rules, 2006 (as amended) specified under Section 133 of the Act read with Companies (Accounts) Rules 2014 (as amended), which have been approved by the Board of Directors at their meeting held on September 30, 2019. The Restated Ind AS Summary Statements also includes proforma Ind AS Summary Statements for the year ended March 31, 2019 which have been prepared from the audited financial statements of the Company as at and for the year ended March 31, 2019; have been adjusted to make them compliant with recognition and measurement under Ind-AS.
- The proforma summary statements of the Company as at and for the year ended March 31, 2019 (Proforma) is prepared in accordance with requirements of SEBI Circular and the Guidance Note. For the purpose of Proforma Financial Statements for the year ended March 31, 2019 (Proforma) the Company has followed the same accounting policy and accounting policy choices (both mandatory exceptions and optional exemptions availed as per Ind AS 101) as initially adopted on transition date i.e. April 01, 2019. Accordingly, suitable restatement adjustments (both re-measurements and reclassifications) in the accounting heads are made to the proforma summary statements for the year ended March 31, 2019 (Proforma) in following accounting policies and accounting policy choices (both mandatory exceptions and optional exemptions) consistent with that used at the date of transition to Ind AS (i.e. April 01, 2019).

This note provides a list of the significant accounting policies adopted in the preparation of these Restated Ind AS Summary Statements. These policies have been consistently applied to all the years presented, unless otherwise stated.

**ii) Basis of Measurement**

The financial statements have been prepared on the going concern basis on a historical cost convention except for certain financial instruments that are measured at fair value at the end of each reporting year.

**iii) Functional currency and rounding of amounts**

The financial statements are presented in Indian National currency Rupee (₹) which is the functional currency of the Company, and all values are rounded to the nearest Million, except where otherwise indicated.

**iv) Use of estimates and judgements**

The preparation of the Company’s financial statements requires management to make estimates and assumptions that affect the reported amounts of revenues, expenses, assets and liabilities, and the accompanying disclosures, and the disclosure of contingent liabilities. Uncertainty about these assumptions and estimates could result in outcomes that require a material adjustment to the carrying amount of assets or liabilities affected in future periods.

***Estimates and Assumptions:***

The key assumptions concerning the future and other key sources of estimation uncertainty at the reporting date, that have a significant risk of causing a material adjustment to the carrying amounts of assets and liabilities within the next financial year, are described below. The Company based its assumptions and estimates on parameters available when the financial statements were prepared. Existing circumstances and assumptions about future developments, however, may change due to market changes or circumstances arising that are beyond the control of the Company. Such changes are reflected in the assumptions when they occur.

**Defined benefit plans (gratuity benefits):**

A liability in respect of defined benefit plans is recognised in the balance sheet, and is measured as the present value of the defined benefit obligation at the reporting date less the fair value of the plan’s assets. The present value of the defined benefit obligation is based on expected future payments which arise from the fund at the reporting date, calculated annually by independent actuaries. Consideration



is given to expected future salary levels, experience of employee departures and periods of service.

Useful economic lives of Property, plant and equipment:

Property, plant and equipment as disclosed in note 3.1 are depreciated over their useful economic lives. Management reviews the useful economic lives at least once a year and any changes could affect the depreciation rates prospectively and hence the asset carrying values.

**v) Current vs Non Current Classification**

The Company presents assets and liabilities in the statement of Assets and Liabilities based on current/noncurrent classification.

An asset is treated as current when it is:

Expected to be realised or intended to be sold or consumed in normal operating cycle

Held primarily for the purpose of trading

Expected to be realised within twelve months after the reporting period, or

Cash or cash equivalent unless restricted from being exchanged or used to settle a liability for at least twelve months after the reporting period

A liability is treated as current when it is:

Expected to be settled in normal operating cycle

Held primarily for the purpose of trading

Due to be settled within twelve months after the reporting period, or

There is no unconditional right to defer the settlement of the liability for at least twelve months after the reporting period

All other assets and liabilities are classified as non-current assets and liabilities. Deferred tax assets and liabilities are classified as non-current assets and liabilities.

The operating cycle is the time between the acquisition of assets for processing and their realization in cash and cash equivalents. The Company has identified twelve months as its operating cycle.

**vi) Inventories**

Inventories are valued at the lower of cost and net realisable value.

Cost of raw materials is determined on a specific identification price basis. However, materials and other items held for use in the production of inventories are not written down below cost if the finished products in which they will be incorporated are expected to be sold at or above cost.

Cost of finished goods and work in progress includes direct materials and labour and a proportion of manufacturing overheads based on normal operating capacity. Material cost is valued at moving weighted average cost.

Cost of spares and consumables is determined on a moving weighted average cost basis. Scrap is valued at estimated realisable value.

Net realizable value is the estimated selling price in the ordinary course of business, less estimated costs of completion and estimated costs necessary to make the sale.

**vii) Cash and cash equivalents**

Cash and cash equivalent in the balance sheet comprise cash at banks and on hand and short-term deposits with an original maturity of three months or less, that are readily convertible to a known amount of cash and subject to an insignificant risk of changes in value.

For the purpose of the Statement of cash flows, cash and cash equivalents consist of cash and short-term deposits, as defined above, net of outstanding bank overdrafts as they are considered an integral part of the Company's cash management.

**viii) Property, Plant and Equipment**

Property, plant and equipment are stated at actual costs, net of accumulated depreciation and accumulated impairment losses, if any. The cost comprises purchase price, borrowing costs if capitalization criteria are met, directly attributable cost of bringing the asset to its working condition

for the intended use and initial estimate of decommissioning, restoring and similar liabilities.

Any trade discounts and rebates are deducted in arriving at the purchase price. Such cost includes the cost of replacing part of the plant and equipment. When significant parts of property, plant and equipment are required to be replaced at intervals, the Company depreciates them separately based on their specific useful lives. Likewise, when a major inspection is performed, its cost is recognised in the carrying amount of the plant and equipment as a replacement if the recognition criteria are satisfied. All other repair and maintenance costs are recognised in profit or loss as incurred.

Items of stores and spares that meet the definition of property, plant and equipment are capitalized at cost and depreciated over their useful life. Otherwise, such items are classified as a part of inventories.

Properties in course of construction for production, supply or administrative purposes are carried at cost, less recognised impairment losses. All the direct expenditures related to the implementation including incidental expenditure incurred during the period of implementation of a project, till it is commissioned is accounted as Capital Work in progress (CWIP) and such properties are classified as appropriate categories of Property, plant and equipment when completed and ready for the intended use.

An item of property, plant and equipment and any significant part initially recognised is derecognised upon disposal or when no future economic benefits are expected from its use or disposal. Any gain or loss arising on derecognition of the asset (calculated as the difference between the net disposal proceeds and the carrying amount of the asset) is included in the statement of profit and loss when the asset is derecognised.

On transition to Ind AS, the company has elected to continue with the carrying values of all of its property, plant and equipments recognised as on 01 April, 2017 measured as per the previous GAAP, and use that carrying values as the deemed cost of such property, plant and equipment.

#### **ix) Depreciation on property, plant and equipment**

Depreciation on property, plant and equipment is calculated on a written down value basis using the rates arrived at, based on the useful lives estimated by the management. The management, on the basis of internal technical assessment of usage pattern, believes that the useful lives as mentioned below best represents the period over which management expects to use these assets. Hence, the useful lives in respect of certain assets are different from the useful lives as prescribed under Part C of Schedule II of the Companies Act, 2013.

<b>Class of Assets</b>	<b>Useful Life Estimated by Management</b>
Buildings	30
Plant & machinery	25
Vehicles	10
Furniture and fixtures	8
Computers	3
Windmill	22

The estimated useful lives and residual values of the property, plant and equipment are reviewed at the end of each reporting year, with the effect of any changes in estimate accounted for on a prospective basis.

Depreciation on items of property, plant and equipment acquired / disposed off during the year is provided on pro-rata basis with reference to the date of addition / disposal.

#### **x) Leases**

The company assesses at contract inception whether a contract is, or contains, a lease. That is, if the contract conveys the right to control the use of an identified asset for a period of time in exchange for consideration.

#### **Company as Lessee -**

Company's leased assets comprises of lands. The company applies a single recognition and measurement approach for all leases, except for short-term leases and leases of low-value assets. The company recognises lease liabilities to make lease payments and right-of-use assets representing the right to use the underlying assets.

##### *a. Right-of-use assets*

The company recognises right-of-use assets at the commencement date of the lease (i.e., the date the underlying asset is available for use).

Right-of-use assets are measured at cost, less any accumulated depreciation and impairment losses, and adjusted for any remeasurement of lease liabilities. The cost of right-of-use assets includes the amount of lease liabilities recognised, initial direct costs incurred, and lease payments made at or before the commencement date less any lease incentives received.

Right-of-use assets are depreciated on a straight-line basis over the lease term and the estimated useful lives of the assets, as follows:

- Right-of-use Assets (Leasehold lands) : 20 years

The right-of-use assets are also subject to impairment. Refer to the accounting policies in section xii (b) Impairment of non-financial assets.

##### *b. Lease liabilities*

At the commencement date of the lease, the company recognises lease liabilities measured at the present value of lease payments to be made over the lease term. The lease payments include fixed payments (including in substance fixed payments) less any lease incentives receivable, variable lease payments that depend on an index or a rate, and amounts expected to be paid under residual value guarantees. The lease payments also include the exercise price of a purchase option reasonably certain to be exercised by the

In calculating the present value of lease payments, the company uses its incremental borrowing rate at the lease commencement date because the interest rate implicit in the lease is not readily determinable. After the commencement date, the amount of lease liabilities is increased to reflect the accretion of interest and reduced for the lease payments made. In addition, the carrying amount of lease liabilities is remeasured if there is a modification, a change in the lease term, a change in the lease payments (e.g., changes to future payments resulting from a change in an index or rate used to determine such lease payments) or a change in the assessment of an option to purchase the underlying asset.

#### **Short-term leases and leases of low-value assets**

The Company applies the short-term lease recognition exemption to its short-term leases (i.e., those leases that have a lease term of 12 months or less from the commencement date with no option for extension and do not contain a purchase option). It also applies the lease of low-value assets recognition exemption to leases that are considered to be low value. Lease payments on short-term leases and leases of low-value assets are recognised as expense on a straight-line basis over the lease term.

#### **Company as Lessor -**

Leases in which the company does not transfer substantially all the risks and rewards incidental to

ownership of an asset are classified as operating leases. Rental income arising is accounted for on a straight-line basis over the lease terms and is included in other income in the statement of profit or loss due to its operating nature. Initial direct costs incurred in negotiating and arranging an operating lease are added to the carrying amount of the leased asset and recognised over the lease term on the same basis as rental income.

**xi) Intangible assets**

Intangible assets acquired separately includes softwares are measured on initial recognition at cost. Following initial recognition, intangible assets are carried at cost less accumulated amortization and accumulated impairment losses, if any.

On transition to Ind AS, the company has elected to continue with the carrying values of its intangible assets recognised as on 01 April 2017 measured as per the previous GAAP, and use that carrying values as the deemed cost of such intangible assets.

Intangible assets are amortized on a straight line basis over the estimated useful economic life of 5 years. The amortization period and the amortization method are reviewed at least at each financial year end. If the expected useful life of the asset is significantly different from previous estimates, the amortization period is changed accordingly.

**xii) Impairment of assets**

**a) Impairment of Financial Instruments/ Financial Assets-**

The company recognises loss allowances for expected credit losses on Financial assets measured at Amortised costs.

For trade receivables and contract assets, the company applies a simplified approach in calculating ECLs. Therefore, the company does not track changes in credit risk, but instead recognises a loss allowance based on lifetime ECLs at each reporting date. The company has established a provision matrix that is based on its historical credit loss experience, adjusted for forward-looking factors specific to the debtors and the economic environment.

**b) Impairment on Non financial Assets -**

The company assesses at each reporting date whether there is an indication that an asset may be impaired. If any indication exists, or when annual impairment testing for an asset is required, the company estimates the asset's recoverable amount.

An asset's recoverable amount is the higher of an asset's or cash-generating units (CGU) net selling price and its value in use. The recoverable amount is determined for an individual asset, unless the asset does not generate cash inflows that are largely independent of those from other assets or company's of assets. Where the carrying amount of an asset or CGU exceeds its recoverable amount, the asset is considered impaired and is written down to its recoverable amount.

In assessing value in use, the estimated future cash flows are discounted to their present value using a pre-tax discount rate that reflects current market assessments of the time value of money and the risks specific to the asset. In determining net selling price, recent market transactions are taken into account, if available. If no such transactions can be identified, an appropriate valuation model is used.

After impairment, depreciation is provided on the revised carrying amount of the asset over its remaining useful life.

**xiii) Financial Instruments**

A financial instrument is any contract that gives rise to a financial asset of one entity and a financial liability or equity instrument of another entity.

## Financial assets

### Initial recognition and measurement

Financial assets are classified, at initial recognition, as subsequently measured at amortised cost, fair value through other comprehensive income (OCI), and fair value through profit or loss.

The classification of financial assets at initial recognition depends on the financial asset's contractual cash flow characteristics and the company's business model for managing them. With the exception of trade receivables that do not contain a significant financing component or for which the company has applied the practical expedient, the company initially measures a financial asset at its fair value plus, in the case of a financial asset not at fair value through profit or loss, transaction costs. Trade receivables that do not contain a significant financing component or for which the company has applied the practical expedient are measured at the transaction price determined under Ind AS 115.

In order for a financial asset to be classified and measured at amortised cost or fair value through OCI, it needs to give rise to cash flows that are 'solely payments of principal and interest (SPPI)' on the principal amount outstanding. This assessment is referred to as the SPPI test and is performed at an instrument level. Financial assets with cash flows that are not SPPI are classified and measured at fair value through profit or loss, irrespective of the business model.

The company's business model for managing financial assets refers to how it manages its financial assets in order to generate cash flows. The business model determines whether cash flows will result from collecting contractual cash flows, selling the financial assets, or both. Financial assets classified and measured at amortised cost are held within a business model with the objective to hold financial assets in order to collect contractual cash flows while financial assets classified and measured at fair value through OCI are held within a business model with the objective of both holding to collect contractual cash flows and selling.

Purchases or sales of financial assets that require delivery of assets within a time frame established by regulation or convention in the market place (regular way trades) are recognised on the trade date, i.e., the date that the company commits to purchase or sell the asset.

### Subsequent measurement

For purposes of subsequent measurement, financial assets are classified in four categories:

- ▶ Financial assets at amortised cost (debt instruments)
- ▶ Financial assets at fair value through other comprehensive income (FVTOCI) with recycling of cumulative gains and losses (debt instruments)
- ▶ Financial assets designated at fair value through OCI with no recycling of cumulative gains and losses upon derecognition (equity instruments)
- ▶ Financial assets at fair value through profit or loss

### Financial assets at amortised cost (debt instruments)

A 'financial asset' is measured at the amortised cost if both the following conditions are met:

- a) The asset is held within a business model whose objective is to hold assets for collecting contractual cash flows, and
- b) Contractual terms of the asset give rise on specified dates to cash flows that are solely payments of principal and interest (SPPI) on the principal amount outstanding.

This category is the most relevant to the company. After initial measurement, such financial assets are subsequently measured at amortised cost using the effective interest rate (EIR) method. Amortised cost is calculated by taking into account any discount or premium on acquisition and fees or costs that are an integral part of the EIR. The EIR amortisation is included in finance income in the profit or loss.

### Financial assets at fair value through OCI (FVTOCI) (debt instruments)

A 'financial asset' is classified as at the FVTOCI if both of the following criteria are met:

a) The objective of the business model is achieved both by collecting contractual cash flows and selling the financial assets, and

b) The asset's contractual cash flows represent SPPI.

Debt instruments included within the FVTOCI category are measured initially as well as at each reporting date at fair value. For debt instruments, at fair value through OCI, interest income, foreign exchange revaluation and impairment losses or reversals are recognised in the profit or loss and computed in the same manner as for financial assets measured at amortised cost. The remaining fair value changes are recognised in OCI. Upon derecognition, the cumulative fair value changes recognised in OCI is reclassified from the equity to profit or loss.

### Financial assets designated at fair value through OCI (equity instruments)

Upon initial recognition, the company can elect to classify irrevocably its equity investments as equity instruments designated at fair value through OCI when they meet the definition of equity under Ind AS 32 Financial Instruments: Presentation and are not held for trading. The classification is determined on an instrument-by-instrument basis. Equity instruments which are held for trading and contingent consideration recognised by an acquirer in a business combination to which Ind AS103 applies are classified as at FVTPL.

Gains and losses on these financial assets are never recycled to profit or loss. Dividends are recognised as other income in the statement of profit and loss when the right of payment has been established, except when the company benefits from such proceeds as a recovery of part of the cost of the financial asset, in which case, such gains are recorded in OCI. Equity instruments designated at fair value through OCI are not subject to impairment assessment.

### Financial assets at fair value through profit or loss

Financial assets at fair value through profit or loss are carried in the balance sheet at fair value with net changes in fair value recognised in the statement of profit and loss.

This category includes derivative instruments and listed equity investments which the company had not irrevocably elected to classify at fair value through OCI. Dividends on listed equity investments are recognised in the statement of profit and loss when the right of payment has been established.

### *Derecognition*

A financial asset (or, where applicable, a part of a financial asset or part of a company of similar financial assets) is primarily derecognised (i.e. removed from the company's balance sheet) when:

- ▶ The rights to receive cash flows from the asset have expired, or
- ▶ The company has transferred its rights to receive cash flows from the asset or has assumed an obligation to pay the received cash flows in full without material delay to a third party under a 'pass-through' arrangement; and either (a) the company has transferred substantially all the risks and rewards of the asset, or (b) the company has neither transferred nor retained substantially all the risks and rewards of the asset, but has transferred control of the asset.

When the company has transferred its rights to receive cash flows from an asset or has entered into a pass-through arrangement, it evaluates if and to what extent it has retained the risks and rewards of ownership. When it has neither transferred nor retained substantially all of the risks and rewards of the asset, nor transferred control of the asset, the company continues to recognise the transferred asset to the extent of the company's continuing involvement. In that case, the company also recognises an

associated liability. The transferred asset and the associated liability are measured on a basis that reflects the rights and obligations that the company has retained.

Continuing involvement that takes the form of a guarantee over the transferred asset is measured at the lower of the original carrying amount of the asset and the maximum amount of consideration that the company could be required to repay.

## **Financial liabilities**

### *Initial recognition and measurement*

Financial liabilities are classified, at initial recognition, as financial liabilities at fair value through profit or loss, loans and borrowings, payables, or as derivatives designated as hedging instruments in an effective hedge, as appropriate.

All financial liabilities are recognised initially at fair value and, in the case of loans and borrowings and payables, net of directly attributable transaction costs.

The company's financial liabilities include trade and other payables, loans and borrowings including bank overdrafts, employee dues and interest accrued on borrowings, other interest payable.

### *Subsequent measurement*

For purposes of subsequent measurement, financial liabilities are classified in two categories:

Financial liabilities at fair value through profit or loss

Financial liabilities at amortised cost (loans and borrowings)

#### Financial liabilities at fair value through profit or loss

Financial liabilities at fair value through profit or loss include financial liabilities held for trading and financial liabilities designated upon initial recognition as at fair value through profit or loss.

Financial liabilities are classified as held for trading if they are incurred for the purpose of repurchasing in the near term.

Financial liabilities designated upon initial recognition at fair value through profit or loss are designated as such at the initial date of recognition, and only if the criteria in Ind AS 109 are satisfied. For liabilities designated as FVTPL, fair value gains/ losses attributable to changes in own credit risk are recognized in OCI. These gains/ losses are not subsequently transferred to P&L.

#### Financial liabilities at amortised cost (Loans and borrowings)

This is the category most relevant to the Company. After initial recognition, interest-bearing loans and borrowings are subsequently measured at amortised cost using the EIR method. Gains and losses are recognised in profit or loss when the liabilities are derecognised as well as through the EIR amortisation process.

Amortised cost is calculated by taking into account any discount or premium on acquisition and fees or costs that are an integral part of the EIR. The EIR amortisation is included as finance costs in the statement of profit and loss.

This category generally applies to borrowings. For more information refer Note 12. Moreover, as assessed by management that the transaction costs incurred on long term term loans are insignificant to the value of loans and prepayment penalty does not exist.

### *Derecognition*

A financial liability is derecognised when the obligation under the liability is discharged or cancelled or expires. When an existing financial liability is replaced by another from the same lender on substantially different terms, or the terms of an existing liability are substantially modified, such an exchange or modification is treated as the derecognition of the original liability and the recognition of a new liability. The difference in the respective carrying amounts is recognised in the statement of profit

and loss.

#### *Offsetting of financial instruments*

Financial assets and financial liabilities are offset and the net amount is reported in the balance sheet if there is a currently enforceable legal right to offset the recognised amounts and there is an intention to settle on a net basis, to realise the assets and settle the liabilities simultaneously.

#### **xiv) Compound Financial Instruments**

Compound financial instruments issued by the company comprises of non convertible redeemable preference shares containing a zero percent dividend redeemable at par at the end of 10 years from the date of allotment and optionally convertible redeemable preference shares containing a zero percent dividend redeemable at par. The liability component of compound financial instrument is initially recognised at fair value. The equity portion is initially recognised as a difference between the fair value of the compound financial instrument as a whole and the fair value of the liability component. Any directly attributable transaction costs are allocated to the liability and equity components in the proportion of their initial carrying amounts.

Subsequent to initial recognition, the liability component of the compound financial instrument is measured at amortised costs using effective interest method. The equity component is not re-measured subsequently. Interest related to the financial liability is recognised in profit and loss (unless it qualifies for inclusion in the cost of an asset).

#### **xv) Revenue from contract with customer**

Revenue from contract with customer is recognised when control of the goods or services are transferred to the customer at an amount that reflects the consideration to which the Company expects to be entitled in exchange for those goods or services. Revenue is measured at the fair value of the consideration received or receivable, taking into account contractually defined terms of payment and excluding taxes or duties collected on behalf of the government.

#### **Sale of goods -**

Revenue from sale of goods is recognised at the point in time when control of the goods is transferred to the customer, generally on dispatch/ delivery of the goods or terms as agreed with the customer. The company considers whether there are other promises in the contract that are separate performance obligations to which a portion of the transaction price needs to be allocated. In determining the transaction price for the sale of goods, the company considers the effects of variable consideration, the existence of significant financing components, non-cash consideration, and consideration payable to the customer (if any).

#### *Variable consideration -*

If the consideration in a contract includes a variable amount, the Company estimates the amount of consideration to which it will be entitled in exchange for transferring the goods to the customer. The variable consideration is estimated at the time of completion of performance obligation and constrained until it is highly probable that a significant revenue reversal in the amount of cumulative revenue recognised will not occur when the associated uncertainty with the variable consideration is subsequently resolved.

#### *Contract assets -*

A contract asset is the right to consideration in exchange for goods transferred to the customer. If the Company performs its obligation by transferring goods to a customer before the customer pays consideration or before payment is due, a contract asset is recognised for the earned consideration that is conditional.

Trade receivables: A receivable represents the Company's right to an amount of consideration that is unconditional (i.e., only the passage of time is required before payment of the consideration is due).



Refer to accounting policies of financial assets i.e. Financial instruments – initial recognition and subsequent measurement.

*Contract liabilities -*

A contract liability is recognised if a payment is received or a payment is due (whichever is earlier) from a customer before the Company transfers the related goods or services. Contract liabilities are recognised as revenue when the Company performs under the contract (i.e., transfers control of the related goods or services to the customer).

**Export incentives**

Export incentives under various schemes notified by government are accounted for in the year of exports based on eligibility and when there is no uncertainty in receiving the same and is included in revenue in the statement of profit and loss due to its operating nature.

**Windmill energy income**

Consideration for electricity generated by the windmill division and fed into the state power grid is received in the form of credit in the manufacturing division's power bill. Credits are recognised as income net of wheeling charges. Income so recognised is shown separately from the power cost under Other operating revenue

**Interest Income**

Interest income from financial assets is recognised when it is probable that the economic benefit will flow to the Company and the amount of income can be measured reliably. Interest income is recorded using the effective interest rate (EIR). Interest income is accrued on a time basis, by reference to the principal outstanding and the interest rate applicable, which is the rate that exactly discounts estimated future cash receipts through the expected life of the financial asset to that asset's net carrying amount on initial recognition.

**Rental Income**

Rental income arising from operating leases is accounted on the basis of lease terms and is included in other income in the statement of profit and loss.

**xvi) Employee benefits**

**Defined Contribution Plan-**

The company's contribution to provident fund is considered as a defined contribution scheme and are charged as expense based on the amount of contribution required to be made and when the services are rendered by the employees.

**Defined Benefit Plan -**

The company operates a defined benefit plan for its employees, viz., gratuity liability. The costs of providing benefits under this plan are determined on the basis of actuarial valuation at each year-end. Actuarial valuation is carried out for the plan using the projected unit credit method. Remeasurements comprising of actuarial gains and losses, the effect of changes to the return on plan assets (excluding net interest) is reflected immediately in the balance sheet with a charge or credit recognised in OCI in the period in which they occur.

Remeasurements recognised in OCI are reflected immediately in retained earnings and is not reclassified to in the statement of profit and loss. Net interest is calculated by applying the discount rate to the net defined benefit liability or asset.

**Long-term employee benefits:**

Compensated absences which are not expected to occur within twelve months after the end of the period in which the employee renders the related service are recognised as a liability at the present value of the estimated future cash outflows expected to be made by the Company in respect of services provided by employees up to the balance sheet date.

**Short term employee benefits:**

Accumulated leave, which is expected to be utilized within the next 12 months, is treated as short-term employee benefit. The company measures the expected cost of such absences as the additional amount that it expects to pay as a result of the unused entitlement that has accumulated at the reporting date.

#### **xvii) Foreign currencies**

The company's financial statements are presented in INR, which is also company's functional currency.

Initial recognition -

Foreign currency transactions are recorded in the reporting currency, by applying to the foreign currency amount the exchange rate between the reporting currency and the foreign currency at the date of the transaction.

Measurement of foreign currency monetary items at the Balance Sheet date -

Foreign currency monetary items are retranslated using the exchange rate prevailing at the reporting date. Non-monetary items, which are measured in terms of historical cost denominated in a foreign currency, are reported using the exchange rate at the date of the transaction.

Treatment of exchange differences -

Exchange differences arising on the settlement of monetary items or on reporting monetary items of company at rates different from those at which they were initially recorded during the year, or reported in previous financial statements, are recognised as income or as expenses in the year in which they arise

#### **xviii) Borrowing costs**

Borrowing costs directly attributable to the acquisition, construction or production of an asset that necessarily takes a substantial period of time to get ready for its intended use or sale are capitalised as part of the cost of the asset. All other borrowing costs are expensed in the period in which they occur. Borrowing costs consist of interest and other costs that an entity incurs in connection with the borrowing of funds. Borrowing cost also includes exchange differences to the extent regarded as an adjustment to the borrowing costs.

#### **xix) Income taxes**

Tax expense comprises current and deferred tax.

Current tax -

The tax currently payable is based on the taxable profits for the years. Current income-tax is measured at the amount expected to be paid to the tax authorities in accordance with the Income-tax Act, 1961 enacted in India.

Management periodically evaluates positions taken in the tax returns with respect to situations in which applicable tax regulations are subject to interpretation and considers whether it is probable that a taxation authority will accept an uncertain tax treatment. The Company shall reflect the effect of uncertainty for each uncertain tax treatment by using either most likely method or expected value method, depending on which method predicts better resolution of the treatment.

The tax rates and tax laws used to compute the amount are those that are enacted or substantively enacted, at the reporting date.

Deferred tax-

Deferred tax is recognised on temporary differences between the carrying amounts of assets and liabilities in the financial statements and the corresponding tax base used in the computation of taxable profit. Deferred tax liabilities are generally recognised for all taxable temporary differences.

Deferred tax assets are generally recognised for all deductible temporary differences to the extent that it is probable that taxable profits will be available against which those deductible temporary differences can be utilised. Such deferred tax assets and liabilities are not recognised if the temporary difference arises from the initial recognition of assets and liabilities in a transaction that affects neither the taxable profit nor the accounting profit.

The carrying amount of deferred tax assets is reviewed at the end of each reporting period and reduced to the extent that it is no longer probable that sufficient taxable profits will be available to allow all or part of the asset to be recovered.

Deferred tax liabilities and assets are measured at the tax rates that are expected to apply in the period in which the liability is settled or the asset realised, based on tax rates (and tax laws) that have been enacted or substantively enacted by the end of the reporting period.

The measurement of deferred tax liabilities and assets reflects the tax consequences that would follow from the manner in which the Company expects, at the end of the reporting period, to recover or settle the carrying amount of its assets and liabilities.

Deferred tax assets include Minimum Alternate Tax (MAT) credit paid in accordance with the tax laws in India, which is likely to give future economic benefits in the form of availability of set off against future income tax liability. Accordingly, MAT credit is recognised as deferred tax asset in the Balance sheet when the asset can be measured reliably and it is probable that the future economic benefit associated with the asset will be realised.

#### **xx) Provisions and contingent liabilities**

Provisions are recognised when the company has a present obligation (legal or constructive) as a result of a past event, it is probable that an outflow of resources embodying economic benefits will be required to settle the obligation and a reliable estimate can be made of the amount of the obligation. When the company expects some or all of a provision to be reimbursed, for example, under an insurance contract, the reimbursement is recognised as a separate asset, but only when the reimbursement is virtually certain. The expense relating to a provision is presented in the statement of profit and loss net of any reimbursement.

If the effect of the time value of money is material, provisions are discounted using a current pre-tax rate that reflects, when appropriate, the risks specific to the liability. When discounting is used, the increase in the provision due to the passage of time is recognised as a finance cost.

When some or all of the economic benefits required to settle a provision are expected to be recovered from a third party, a receivable is recognised as an asset if it is virtually certain that reimbursement will be received and the amount of the receivable can be measured reliably.

Contingent liabilities and Contingent assets are not recognised in the financial statements when an inflow/ outflow of economic benefits/ loss is not probable.

#### **xxi) Operating Segments**

Basis of Segmentation-

The company is mainly engaged in the business of manufacturing and selling of machined / forged rings and auto components. The company's business falls within a single business segment of 'diversified auto components' and all the activities of the Company revolve around this main business.

The Chief Operating decision maker (CODM) monitors the operating results of the business as a whole for the purpose of making decisions about resource allocation and performance assessment.

Therefore, management views company's business activity as a single segment and segment's performance is evaluated based on profit or loss and is measured consistently with profit or loss in the financial statements.

Geographical Information -

The management evaluates that the company operates in two principal geographical areas - India and

Outside India.

Company's Revenue and Receivables are specified by location of customers and the other geographic information (Segment Assets and Capital Expenditure) are specified by location of the assets.

#### **xxii) Earnings per share**

Basic earnings per share are calculated by dividing the net profit or loss for the period attributable to equity shareholders by the weighted average number of equity shares outstanding during the period.

For the purpose of calculating diluted earnings per share, the net profit or loss for the period attributable to equity shareholders and the weighted average number of shares outstanding during the period are adjusted for the effects of all dilutive potential equity shares. Potential equity shares are deemed to be dilutive only if their conversion to equity shares would decrease the net profit per share from continuing ordinary operations. Potential dilutive equity shares are deemed to be converted as at the beginning of the period, unless they have been issued at a later date. The dilutive potential equity shares are adjusted for the proceeds receivable had the shares been actually issued at fair value (i.e. average market value of the outstanding shares). Dilutive potential equity shares are determined independently for each year presented.

#### **xxiii) Fair Value Measurement**

The Company measures certain financial instruments at fair value at each balance sheet date. Fair value is the price that would be received to sell an asset or paid to transfer a liability in an orderly transaction between market participants at the measurement date. The fair value measurement is based on the presumption that the transaction to sell the asset or transfer the liability takes place either:

the principal market for the asset or liability, or  
In the absence of a principal market, in the most advantageous market for the asset or liability

The principal or the most advantageous market must be accessible by the Company. The fair value of an asset or a liability is measured using the assumptions that market participants would use when pricing the asset or liability, assuming that market participants act in their economic best interest. A fair value measurement of a non-financial asset takes into account a market participant's ability to generate economic benefits by using the asset in its highest and best use or by selling it to another market participant that would use the asset in its highest and best use.

The Company uses valuation techniques that are appropriate in the circumstances and for which sufficient data are available to measure fair value, maximising the use of relevant observable inputs and minimising the use of unobservable inputs. All assets and liabilities for which fair value is measured or disclosed in the financial statements are categorised within the fair value hierarchy, described as under, based on the lowest level input that is significant to the fair value measurement as a whole:

- Level 1 - Quoted (unadjusted) market prices in active markets for identical assets or liabilities.
- Level 2 - Valuation techniques for which the lowest level input that is significant to the fair value measurement is directly or indirectly observable
- Level 3 - Valuation techniques for which the lowest level input that is significant to the fair value measurement is unobservable

For assets and liabilities that are recognised in the financial statements on a recurring basis, the Company determines whether transfers have occurred between levels in the hierarchy by re-assessing categorisation (based on the lowest level input that is significant to the fair value measurement as a whole) at the end of each reporting period.

The Company's management determines the policies and procedures for both recurring fair value measurement, such as unquoted financial assets measured at fair value, and for non-recurring measurement, such as assets held for distribution in discontinued operations. The management

comprises of the Managing Director and Chief Finance Officer (CFO).

External valuers are involved for valuation of significant assets. Involvement of external valuers is decided upon annually by the board of directors after discussion with and approval by the management. Selection criteria include market knowledge, reputation, independence and whether professional standards are maintained. Valuers are normally rotated every three years. The management decides, after discussions with the Company's external valuers, which valuation techniques and inputs to use for each case.

At each reporting date, the management analyses the movements in the values of assets and liabilities which are required to be re-measured or re-assessed as per the Company's accounting policies. For this analysis, the management verifies the major inputs applied in the latest valuation by agreeing the information in the valuation computation to contracts and other relevant documents.

The management, in conjunction with the Company's external valuers, also compares the change in the fair value of each asset and liability with relevant external sources to determine whether the change is reasonable.

For the purpose of fair value disclosures, the Company has determined classes of assets and liabilities on the basis of the nature, characteristics and risks of the asset or liability and the level of the fair value hierarchy as explained above.

## **PRINCIPAL COMPONENTS OF REVENUE AND EXPENDITURE**

The components of our revenue and expenditure are as set forth below.

### ***Total Income***

Our total income consists of (i) revenue from operations and (ii) other income.

### ***Revenue from operations***

Our Revenue from operations comprise the following:

- a. Revenue from contracts with customer comprises of sale of goods through contracts with customers, and
- b. Other operating revenue which comprises of
  - scrap sales,
  - export incentives, and
  - windmill income

### ***Other income***

Our other income primarily comprises of (i) interest income on bank deposits, (ii) foreign exchange differences (net), (iii) other interest income, (iv) rental income and, (v) profit on sale of plant property and equipment (net) and (vi) miscellaneous Income.

### ***Expenses***

Our expenses comprise of (i) cost of raw materials and components consumed, (ii) decrease or (increase) in inventories of finished goods and work-in-progress, (iv) employee benefits expense, (v) finance costs, (vi) depreciation and amortisation expense and (vii) other expenses.

### ***Cost of raw materials and components consumed***

Cost of materials consumed include cost of raw materials such as alloys steels and others. The expense is computed based on purchases during the year adjusted for change in inventory during the year.

### ***Decrease/(increase) in inventories of finished goods and work-in-progress***

Changes in inventories of finished goods and work-in-progress.

### Employee benefits expense

Our employee benefits expense consists of (a) salaries, wages and bonus, (b) contribution to provident fund and other funds, (c) gratuity expenses and (d) staff welfare expenses.

### Finance costs

Our finance costs consist of (a) Interest on bank borrowings, (b) interest on liability component of compound financial instrument, (c) interest on lease liabilities, and (d) exchange differences regarded as an adjustment to borrowing costs, and (v) other finance charges.

### Depreciation and amortization expense

Our depreciation/amortization expense relate to (a) depreciation of property, plant and equipment, (b) depreciation of right of use assets, and (c) amortisation of intangible assets.

### Other expenses

Other expenses includes, amongst others: (a) power and fuel, (b) consumption of stores, spares and consumables, (c) labour charges, (d) freight and forwarding charges, (e) net loss on foreign currency transactions other than those on financial cost, (f) insurance, (g) repairs and maintenance (plant and machinery, buildings and others), (h) sorting, segregation and testing charges, (i) windmill expenses, (j) CSR expenses, (k) rates and taxes, (l) sales promotion, (m) travelling and conveyance, (n) legal and professional fees, (o) printing and stationery, (p) loss on sale of property, plant and equipment (net), (q) communication costs, (r) payment to auditors as statutory audit fees and other services, (s) annual maintenance charges (t) provision for impairment allowance of financial assets (net), (u) donations, and (v) miscellaneous expenses.

## SUMMARY OF RESULTS OF OPERATIONS

The following table sets forth select financial data from our restated statement of profit and loss for Fiscals 2019, 2020, and 2021, the components of which are also expressed as a percentage of total income for such periods.

Particulars	Fiscal 2021		Fiscal 2020		Fiscal 2019 (Proforma)	
	Amount	% of Total Income	Amount	% of Total Income	Amount	% of Total Income
<b>Income</b>						
Revenue from operations	6,163.32	99.45	6,659.94	98.62	9,043.23	99.24
Other income	34.25	0.55	93.38	1.38	69.31	0.76
<b>Total income (I)</b>	<b>6,197.57</b>	<b>100.00</b>	<b>6,753.32</b>	<b>100.00</b>	<b>9,112.54</b>	<b>100.00</b>
<b>Expenses</b>						
Cost of raw materials and components consumed	3,165.94	51.08	3,137.41	46.46	4,529.36	49.70
(Increase) / Decrease in inventories of finished goods and work-in-progress	(291.60)	(4.71)	155.92	2.31	(190.06)	(2.09)
Employee benefits expense	518.66	8.37	526.59	7.80	608.06	6.67
Finance costs	116.99	1.89	321.69	4.76	420.19	4.61
Depreciation and amortisation expense	254.09	4.10	265.24	3.93	254.40	2.79
Other expenses	1,681.64	27.13	1,625.64	24.07	2,084.99	22.88
<b>Total expenses (II)</b>	<b>5,445.72</b>	<b>87.87</b>	<b>6,032.49</b>	<b>89.33</b>	<b>7,706.94</b>	<b>84.58</b>
<b>Restated profit before tax (III) = (I - II)</b>	<b>751.85</b>	<b>12.13</b>	<b>720.83</b>	<b>10.67</b>	<b>1,405.60</b>	<b>15.42</b>
<b>Tax expense</b>						

Particulars	Fiscal 2021		Fiscal 2020		Fiscal 2019 (Proforma)	
	Amount	% of Total Income	Amount	% of Total Income	Amount	% of Total Income
Current tax expenses	130.42	2.10	127.17	1.88	308.90	3.39
Deferred tax charge/ (Credit)	(248.12)	(4.00)	64.25	0.95	506.29	5.56
<b>Total tax expense (IV)</b>	<b>(117.70)</b>	<b>(1.90)</b>	<b>191.42</b>	<b>2.83</b>	<b>815.19</b>	<b>8.95</b>
<b>Restated profit for the year (V) = (III - IV)</b>	<b>869.55</b>	<b>14.03</b>	<b>529.41</b>	<b>7.84</b>	<b>590.41</b>	<b>6.48</b>
<b>Other comprehensive income (OCI)</b>						
<b>Items not to be reclassified to profit or loss in subsequent year :</b>						
Re-measurement gains/ (losses) on defined benefit plans	7.81	0.13	(2.77)	(0.04)	(0.35)	-
Less: Income tax relating to these items	(2.73)	(0.04)	0.97	0.01	0.12	-
<b>Restated total other comprehensive income for the year, net of tax (VI)</b>	<b>5.08</b>	<b>0.08</b>	<b>(1.80)</b>	<b>(0.03)</b>	<b>(0.23)</b>	<b>-</b>
<b>Restated total comprehensive income for the year, net of tax (VII)=(V+VI)</b>	<b>874.63</b>	<b>14.11</b>	<b>527.61</b>	<b>7.81</b>	<b>590.18</b>	<b>6.48</b>

### Fiscal 2021 compared to Fiscal 2020

#### Total income

Our total income decreased by 8.23% from ₹ 6,753.32 million in Fiscal 2020 to ₹ 6,197.57 million in Fiscal 2021 due to decrease in revenue from operations as mentioned below.

#### Revenue from operations

Our revenue from operations decreased by 7.46% from ₹ 6,659.94 million in Fiscal 2020 to ₹ 6,163.32 million in Fiscal 2021, predominantly as a result of a decrease in our revenue from contracts with customers and other operating revenue for the reasons mentioned below.

*Revenue from contracts with customers:* Our revenue from sales of goods decreased by 7.72% from ₹ 6,158.93 million in Fiscal 2020 to ₹ 5,683.30 million in Fiscal 2021 on account of unfavourable demand scenario in the automobile industry and because of COVID-19 pandemic especially during the initial months of Fiscal 2021.

*Other operating revenue:* Our other operating revenue also decreased by 4.19% from ₹ 501.01 million in Fiscal 2020 to ₹ 480.02 million in Fiscal 2021 led by decrease in export incentives by 39.95% from ₹ 158.07 million in Fiscal 2020 to ₹ 94.92 million in Fiscal 2021 and decrease in windmill income by 34.79% from ₹ 78.00 million in Fiscal 2020 to ₹ 50.86 million in Fiscal 2021 which is partially offset by increase in scrap sales by 26.16% from ₹ 264.94 million in Fiscal 2020 to ₹ 334.24 million in Fiscal 2021. While our revenue from sale of scrap is linked to our scale of operations and price of scrap, our revenues from export incentives is dependent on exports and government policy around such incentives.

#### Other income

Our other income decreased by 63.32% from ₹ 93.38 million in Fiscal 2020 to ₹ 34.25 million in Fiscal 2021, primarily due to reduction in net gain on foreign exchange difference, other interest income and rental income

which was partially offset by increase in profit on sale of plant property and equipment (net) and interest income on bank deposits.

### ***Expenses***

Our total expenses decreased by 9.73% from ₹ 6,032.49 million in Fiscal 2020 to ₹ 5,445.72 million in Fiscal 2021 primarily due to decrease in inventories of finished goods and work-in-progress, employee benefits expense and finance costs which was partially offset by increase in cost of raw materials and components consumed, and other expenses.

#### *Cost of raw materials and components consumed.*

Our cost of raw materials and components consumed increased by 0.91% from ₹ 3,137.41 million in Fiscal 2020 to ₹ 3,165.94 million in Fiscal 2021. This increase was primarily due to higher raw material prices.

*Decrease/(increase) in inventories of finished goods and work-in progress.*

Change in inventories of finished goods and work-in-progress moved from ₹ 155.92 million in Fiscal 2020 to ₹ (291.60) million in Fiscal 2021 due to higher amount of sales in transit as at March 31, 2021 compared to sales in transit as at March 31, 2020.

#### *Employee benefit expenses*

Our employee benefit expenses decreased by 1.51% from ₹ 526.59 million in Fiscal 2020 to ₹ 518.66 million in Fiscal 2021, primarily due to decrease in payment of salaries, wages and bonus, contributions to provident and other funds which was partially offset by increase in staff welfare and gratuity expenses.

#### *Finance costs*

Our finance costs decreased by 63.63% from ₹ 321.69 million in Fiscal 2020 to ₹ 116.99 million in Fiscal 2021, primarily due to decrease in interest on bank borrowings by 25.81% from ₹ 196.98 million in Fiscal 2020 to ₹ 146.14 million in Fiscal 2021 led by decrease in total borrowings from ₹ 2,589.53 million in Fiscal 2020 to ₹ 2,494.91 million in Fiscal 2021, and decrease in exchange differences regarded as an adjustment to borrowing costs and Interest on lease liabilities. This was partially offset by increase in interest on liability component of compound financial instrument and other finance charges.

#### *Depreciation and amortisation expense*

Depreciation and amortisation expenses decreased by 4.21% from ₹ 265.24 million in Fiscal 2020 to ₹ 254.09 million in Fiscal 2021 due to decrease in depreciation of property, plant and equipment, as well as in amortization of intangible assets.

#### *Other expenses*

Our other expenses increased by 3.44% from ₹ 1,625.64 million in Fiscal 2020 to ₹ 1,681.64 million in Fiscal 2021. This increase was primarily due to increase in labour charges from ₹ 229.65 million in Fiscal 2020 to ₹ 252.75 million in Fiscal 2021, increase in consumption of stores, spares and consumables from ₹ 430.79 million in Fiscal 2020 to ₹ 445.59 million in Fiscal 2021 and increase in sorting, segregation and testing charges, CSR expenses, freight and forwarding charges, insurance and legal and professional fees. This was offset by decrease in power and fuel expenses from ₹ 541.84 million in Fiscal 2020 to ₹ 520.55 million in Fiscal 2021 and decrease in expenses including repair and maintenance (plant, building, machinery and others), windmill expenses, travelling and conveyance expenses. Further, as a percentage of our total income, other expenses increased to 27.13% in Fiscal 2021 from 24.07% in Fiscal 2020.

### ***Restated profit before tax***

As a result of the foregoing, our restated profit before tax increased by 4.30% from ₹ 720.83 million in Fiscal 2020 to ₹ 751.85 million in Fiscal 2021.



### ***Total tax expense***

Total tax expense decreased from ₹ 191.42 million in Fiscal 2020 to ₹ (117.70) million in Fiscal 2021, primarily due to decrease in deferred tax charge/credit which was partially offset by small increase in current tax expenses.

### ***Restated profit after tax***

As a result of the above, our restated profit after tax increased by 64.25% from ₹ 529.41 million in Fiscal 2020 to ₹ 869.55 million in Fiscal 2021.

### **Fiscal 2020 compared to Fiscal 2019**

#### ***Total income***

Our total income decreased by 25.89% from ₹ 9,112.54 million in Fiscal 2019 to ₹ 6,753.32 million in Fiscal 2020 due to decrease in revenue from operations as mentioned below.

#### ***Revenue from operations***

Our revenue from operations decreased by 26.35% from ₹ 9,043.23 million in Fiscal 2019 to ₹ 6,659.94 million in Fiscal 2020, predominantly as a result of a decrease in our revenue from contracts with customers and other operating revenue for the reasons mentioned below.

***Revenue from contracts with customers:*** Our revenue from sales of goods decreased by 25.70% from ₹ 8,289.47 million in Fiscal 2019 to ₹ 6,158.93 million in Fiscal 2020 on account of unfavourable demand scenario in the automobile industry and because of COVID-19 pandemic. Further, our operations were closed for last few days of the Fiscal 2020 because of government stipulations to contain COVID-19.

***Other operating revenue:*** Our other operating revenue also decreased by 33.53% from ₹ 753.76 million in Fiscal 2019 to ₹ 501.01 million in Fiscal 2020 led by decrease in scrap sales by 38.61% from ₹ 431.54 million in Fiscal 2019 to ₹ 264.94 million in Fiscal 2020, decrease in export incentives by 34.70% from ₹ 242.08 million in Fiscal 2019 to ₹ 158.07 million in Fiscal 2020 and decrease in windmill income by 2.67% from ₹ 80.14 million in Fiscal 2019 to ₹ 78.00 million in Fiscal 2020. While our revenue from sale of scrap is linked to our scale of operations and price of scrap, our revenues from export incentives is dependent on exports and government policy around such incentives.

#### ***Other income***

Our other income increased by 34.73% from ₹ 69.31 million in Fiscal 2019 to ₹ 93.38 million in Fiscal 2020, primarily due to net gain on foreign exchange difference, other interest income and rental income which was partially offset by decrease in profit on sale of plant property and equipment (net) and interest income on bank deposits.

### ***Expenses***

Our total expenses decreased by 21.73% from ₹ 7,706.94 million in Fiscal 2019 to ₹ 6,032.49 million in Fiscal 2020 primarily due to decrease in cost of raw materials and components consumed, decrease in inventories of finished goods and work-in-progress, employee benefits expense, finance costs and other expenses.

#### ***Cost of raw materials and components consumed.***

Our cost of raw materials and components consumed decreased by 30.73% from ₹ 4,529.36 million in Fiscal 2019 to ₹ 3,137.41 million in Fiscal 2020. This decrease was primarily due to reduced level of operations.

#### ***Decrease/(increase) in inventories of finished goods and work-in progress.***

Change in inventories of finished goods and work-in-progress moved from ₹ (190.06) million in Fiscal 2019 to ₹ 155.92 million in Fiscal 2020 due to reduced amount of sales in transit as at March 31, 2020 compared to sales in transit as at March 31, 2019 and also changes made to holding levels of inventories due to evolving business scenario in light of COVID-19 pandemic.

### *Employee benefit expenses*

Our employee benefit expenses decreased by 13.40% from ₹ 608.06 million in Fiscal 2019 to ₹ 526.59 million in Fiscal 2020, primarily due to decrease in payment of salaries, bonus and allowances, contributions to provident and other funds, and staff welfare expenses primarily on account of decrease in number of employees.

### *Finance costs*

Our finance costs decreased by 23.44% from ₹ 420.19 million in Fiscal 2019 to ₹ 321.69 million in Fiscal 2020, primarily due to decrease in interest on bank borrowings by 43.21% from ₹ 346.86 million in Fiscal 2019 to ₹ 196.98 million in Fiscal 2020 led by decrease in total borrowings from ₹ 3,851.68 million in Fiscal 2019 to ₹ 2,589.53 million in Fiscal 2020, decrease in other finance charges by 39.96% from ₹ 65.47 million in Fiscal 2019 to ₹ 39.31 million in Fiscal 2020 and 11.76% decrease in Interest on lease liabilities. This was partially offset by increase in interest on liability component of compound financial instrument and exchange differences regarded as an adjustment to borrowing costs.

### *Depreciation and amortisation expense*

Depreciation and amortisation expenses increased by 4.26% from ₹ 254.40 million in Fiscal 2019 to ₹ 265.24 million in Fiscal 2020 due to increase in depreciation of property, plant and equipment, and increase in amortization of intangible assets.

### *Other expenses*

Our other expenses decreased by 22.03% from ₹ 2,084.99 million in Fiscal 2019 to ₹ 1,625.64 million in Fiscal 2020. This decrease was primarily due to decrease in power and fuel expenses from ₹ 714.89 million in Fiscal 2019 to ₹ 541.84 million in Fiscal 2020, decrease in consumption of stores, spares and consumables from ₹ 700.30 million in Fiscal 2019 to ₹ 430.79 million in Fiscal 2020 due to decrease in overall operations. Further, as a percentage of our total income, other expenses increased to 24.07% in Fiscal 2020 from 22.88% in Fiscal 2019.

### ***Restated profit before tax***

As a result of the foregoing, our restated profit before tax decreased by 48.72% from ₹ 1,405.60 million in Fiscal 2019 to ₹ 720.83 million in Fiscal 2020.

### ***Total tax expense***

Total tax expense decreased by 76.52% from ₹ 815.19 million in Fiscal 2019 to ₹ 191.42 million in Fiscal 2020, primarily due to decrease in current tax expenses and deferred tax charge.

### ***Restated profit after tax***

As a result of the above, our restated profit after tax decreased by 10.33% from ₹ 590.41 million in Fiscal 2019 to ₹ 529.41 million in Fiscal 2020.

## **LIQUIDITY AND CAPITAL RESOURCES**

We fund our operations primarily with cash flow from operating activities and borrowings under term loan and working capital facilities from banks and financial institutions. We evaluate our funding requirements regularly in light of our cash flow from our operating activities and market conditions. To the extent we do not generate sufficient cash flow from operating activities, we may rely on debt financing activities, subject to market conditions.

We had cash and cash equivalents of ₹ 46.12 million, ₹ 12.45 million, and ₹ 1.38 million as of, March 31, 2021, 2020, and 2019, respectively. Our anticipated cash flows are however dependent on several factors beyond our control. Set forth below is a summary of our cash flow data for the periods indicated.

### **Cash Flows**

The following table sets forth certain information relating to our cash flows in the periods:

(in ₹ million)

Particulars	Year ended March 31,		
	2021	2020	2019 (Proforma)
Net cash flows from operating activities	592.14	1,837.77	1,938.05
Net cash flows (used in) investing activities	(363.08)	(141.70)	(363.49)
Net cash flows (used in) financing activities	(195.39)	(1,685.00)	(1,580.12)
Cash and cash equivalents at the end of the year	46.12	12.45	1.38

### ***Cash Flows from Operating Activities***

#### *Fiscal 2021*

Our net cash flow from operating activities for Fiscal 2021 was ₹ 592.14 million. Restated profit before tax for the fiscal was ₹ 751.85 million and our operating profit before working capital changes for the period was ₹ 1,077.65 million primarily as a result of adjustments made for depreciation and amortization, finance cost, interest income and unrealized gain on foreign exchange (net). Working capital adjustments to our operating profit before working capital changes for the period included increase in trade receivables by ₹ 417.85 million, increase in trade payables by ₹ 447.96 million, increase in inventories by ₹ 405.01 million, increase in other financial liabilities, other liabilities and provisions by ₹ 22.49 million, increase in loans, other financial assets and other assets by ₹ 74.70 million and direct taxes paid (net of refunds) of ₹ 58.40 million.

#### *Fiscal 2020*

Our net cash flow from operating activities for Fiscal 2020 was ₹ 1,837.77 million. Restated profit before tax for the fiscal was ₹ 720.83 million and our operating profit before working capital changes for the period was ₹ 1,306.76 million primarily as a result of adjustments made for depreciation and amortization, finance cost, interest income and unrealized gain on foreign exchange (net). Working capital adjustments to our operating profit before working capital changes for the period included decrease in trade receivables by ₹ 611.18 million, decrease in trade payables by ₹ 184.01 million, decrease in inventories by ₹ 296.29 million, increase in other financial liabilities, other liabilities and provisions by ₹ 1.16 million, decrease in loans, other financial assets and other assets by ₹ 28.82 million and direct taxes paid (net of refunds) of ₹ 222.43 million.

#### *Fiscal 2019*

Our net cash flow from operating activities for Fiscal 2019 was ₹ 1,938.05 million. Restated profit before tax for the fiscal was ₹ 1,405.60 million and our operating profit before working capital changes for the period was ₹ 2,039.79 million primarily as a result of adjustments made for depreciation and amortization, finance cost, interest income and unrealized gain on foreign exchange (net). Working capital adjustments to our operating profit before working capital changes for the period included decrease in trade receivables by ₹ 168.60 million, decrease in trade payables by ₹ 58.33 million, decrease in inventories by ₹ 6.67 million, increase in other financial liabilities, other liabilities and provisions by ₹ 8.20 million, decrease in loans, other financial assets and other assets by ₹ 121.99 million and direct taxes paid (net of refunds) of ₹ 348.87 million.

### ***Cash flows from investing activities***

#### *Fiscal 2021*

Our net cash used in investing activities in the Fiscal ended March 31, 2021, was ₹ 363.08 million, on account of purchase of property, plant and equipment and intangible assets (including capital advances) and capital work in progress aggregating to ₹ 387.29 million and investment in margin money deposits aggregating to ₹ 103.06 million which was partially offset by redemption of margin money deposits having original maturity more than 12 months of ₹ 93.86 million, proceeds from sale of property, plant and equipment of ₹ 2.43 million, interest received aggregating to ₹ 5.98 million and inter corporate deposit received from related party aggregating to ₹ 25.00 million.

#### *Fiscal 2020*

Our net cash used in investing activities in the Fiscal ended March 31, 2020, was ₹ 141.70 million, on account of purchase of property, plant and equipment and intangible assets (including capital advances) and capital work in progress aggregating to ₹ 160.94 million, investment in margin money deposits aggregating to ₹ 106.66 million and proceeds from sale of property, plant and equipment of ₹ 3.80 million which was partially offset by redemption of margin money deposits having original maturity more than 12 months of ₹ 91.03 million, interest received aggregating to ₹ 22.77 million and inter corporate deposit received from related party aggregating to ₹ 8.30 million.

#### *Fiscal 2019*

Our net cash used in investing activities in the Fiscal ended March 31, 2019, was ₹ 363.49 million, on account of purchase of property, plant and equipment and intangible assets (including capital advances) and capital work in progress aggregating to ₹ 367.41 million, investment in margin money deposits aggregating to ₹ 135.94 million and proceeds from sale of property, plant and equipment of ₹ 4.57 million which was partially offset by redemption of margin money deposits having original maturity more than 12 months of ₹ 135.96 million, interest received aggregating to ₹ 7.63 million and inter corporate deposit given to related party aggregating to ₹ 8.30 million.

#### **Cash Flow from/ (used in) Financing Activities**

#### *Fiscal 2021*

Our net cash used in financing activities for the Fiscal ended March 31, 2021 was ₹ 195.39 million, primarily on account of repayment of short term borrowings (net) of ₹ 97.24 million, repayment of long term borrowings of ₹ 223.54 million, payment of principal portion of lease liabilities of ₹ 0.39 million and interest paid of ₹ 108.62 million which was partially offset by proceeds from long-term borrowings of ₹ 208.10 million and proceeds from issue of Optionally Convertible Redeemable Preference Shares of ₹ 26.30 million.

#### *Fiscal 2020*

Our net cash used in financing activities for the Fiscal ended March 31, 2020 was ₹ 1,685.00 million, primarily on account of repayment of short term borrowings (net) of ₹ 480.72 million, repayment of long term borrowings of ₹ 866.68 million, payment of principal portion of lease liabilities of ₹ 0.39 million and interest paid of ₹ 337.21 million.

#### *Fiscal 2019*

Our net cash used in financing activities the Fiscal ended March 31, 2019 was ₹ 1,580.12 million, primarily on account of repayment of short term borrowings (net) of ₹ 257.68 million, repayment of long term borrowings of ₹ 909.72 million, payment of principal portion of lease liabilities of ₹ 0.39 million and interest paid of ₹ 412.33 million.

### **BORROWINGS**

Our total borrowings as at March 31, 2021, March 31, 2020, and March 31, 2019 was ₹ 2,494.91 million, ₹ 2,589.53 million, and ₹ 3,851.68 million.

The following table provides the types and amounts of our outstanding borrowings as at the dates indicated:

Particulars	<i>(in ₹ million)</i>		
	As at March 31, 2021	As at March 31, 2020	As at March 31, 2019
<b>Long term borrowings at amortised cost</b>			
Term loans (secured)*	323.45	442.43	913.40
<b>Total long term borrowings (A)</b>	<b>323.45</b>	<b>442.43</b>	<b>913.40</b>
<b>Current maturities of long-term debts</b>			
Term loans	335.74	207.84	595.03
<b>Total current maturities of long-term debts (B)</b>	<b>335.74</b>	<b>207.84</b>	<b>595.03</b>
<b>Short term borrowings at amortised cost (secured)</b>			
Cash credit from bank	171.11	190.83	301.13
Other working capital facilities	1,664.62	1,748.43	2,042.12

Particulars	As at March 31, 2021	As at March 31, 2020	As at March 31, 2019
Total Short term borrowings (C)	1,835.72	1,939.26	2,343.25
Total borrowings (A) + (B) + (C)	2,494.91	2,589.53	3,851.68

## CONTINGENT LIABILITIES

As on March 31, 2021, we had certain contingent liabilities as per Ind AS 37 that have not been provided:

Particulars	As on March 31, 2021
<i>(in ₹ million)</i>	
<b>Contingent liabilities</b>	
Disputed Income tax/ Sales tax/ Service tax	
Income tax with respect to matters relating to disallowance of additional depreciation, disallowance of forex loss, disallowance of foreign commission and disallowance of other expenditure for the assessment years 2005-06 to 2017-18 in respect of which the Company has filed an appeal with higher authorities	138.73
For non receipt of the required forms and non acceptance of the companies claim of certain sales as an exempted sales and related matters	0.25
Service tax with respect to the matters decided against the company in respect of which the company has filed appeal with higher authorities	1.41

## CAPITAL AND OTHER COMMITMENTS

As at March 31, 2021, the estimated amount of contracts remaining to be executed by us and not provided for (net of advances) was ₹ 328.53 million.

The table below summarizes the maturity profile of the Company's financial liabilities as of March 31, 2021:

Particulars	On demand	Within one year	Within one to five years	More than 5 years	Total
<i>(in ₹ million)</i>					
Term loan from banks	-	-	208.10	-	208.10
Non Convertible Preference Shares - Liability component of compound Financial instruments	-	-	100.59	-	100.59
Optionally Convertible Preference Share-Liability component of compound Financial Instruments	-	-	-	14.76	14.76
Lease Liabilities - Non current	-	-	-	0.67	0.67
Short term Borrowings	171.11	-	-	-	171.11
Short term Borrowings	-	1,664.62	-	-	1,664.62
Trade Payables	-	1,176.35	-	-	1,176.35
Current maturities of Borrowings - Non current	-	335.74	-	-	335.74
Employee dues	-	53.28	-	-	53.28
Lease Liabilities - Current	-	0.39	-	-	0.39
Payables for capital goods	-	44.95	-	-	44.95
<b>Total</b>	<b>171.11</b>	<b>3,275.32</b>	<b>308.69</b>	<b>15.43</b>	<b>3,770.54</b>

## OFF-BALANCE SHEET ARRANGEMENTS

As of March 31, 2021, our Company does not have any off-balance sheet arrangements, derivative instruments or other relationships with any entities that would have been established for the purpose of facilitating off balance sheet arrangements.

## CAPITAL EXPENDITURE

Our capital expenditure (cash outflow) includes purchase of property, plant and equipment and intangible assets (including capital advances) and capital work in progress. The following table sets out the cash outflow on capital expenditure for the periods indicated:

	<i>(In ₹ million)</i>		
Particulars	Fiscal 2021	Fiscal 2020	Fiscal 2019
Purchase of property, plant and equipment and intangible assets (including capital advances) and capital work in progress	(387.29)	(160.94)	(367.41)

## QUANTITATIVE AND QUALITATIVE DISCLOSURE OF MARKET RISK

In the course of business, amongst others, our Company is exposed to several financial risks arising from our underlying operations and finance activities. Our Company is primarily exposed to market risk (i.e. interest rate and foreign currency risk), credit risk and liquidity risk.

### *Market Risk*

Our Company is exposed to the market risk arising out of the fluctuations in fair value of future cash flows of a financial instrument because of changes in market prices. Financial instruments affected by market risk includes loans and borrowings, deposits and investments. Market risk comprises two types of risks: foreign currency risk and interest rate risk. Details of the foreign currency risk and interest rate risk are set forth below:

### *Interest Rate Risk*

Interest rate risk is the risk that the fair value or future cash flows of a financial instrument will fluctuate on account of changes in market interest rates. Interest rates for borrowings have been volatile in India in recent periods. Changes in interest rates may cause variations in interest income and expenses resulting from interest bearing assets and liabilities. Our Company's exposure to the risk of changes in market interest rates relates primarily to our Company's debt obligations with floating interest rates. As of March 31, 2021, our Company has instruments with variable interest rate of ₹ 2,379.56 million. Therefore, fluctuations in interest rates could have the effect on the interest due on our Company's outstanding debt and interest expenses.

### *Foreign Exchange Risk*

For the financial years ended March 31, 2021, 2020 and 2019, 56.12%, 53.82% and 56.27% respectively of our revenue from operations from outside India. Further, we import a part of our cost of raw materials and components consumed. Our imports and exports are predominantly denominated in currencies such as UDS and Euro. We may be affected by fluctuations in the currency exchange rate between these currencies and the Indian Rupee. While imports offer us a partial hedge, we are still exposed to the fluctuation in currencies and for the Fiscal 2021 foreign exchange differences (net) included in other income and exchange difference regarded as an adjustment to borrowing costs included in finance costs amounted to ₹ 100.32 million which amounted to 1.63% of our revenues from operations. For Fiscal 2020, and 2019, foreign exchange differences (net) included in other income and exchange difference regarded as an adjustment to borrowing costs included in finance costs amounted to ₹ (0.23) million, and ₹ 49.36 million and constituted (0.01%), and 0.55% of our revenue from operations, respectively. The exchange rate between the Indian Rupee and various foreign currencies, including USD and Euro, has fluctuated significantly in the past.

### *Liquidity Risk*

Our Company faces the risk that it may not have sufficient cash flows to meet its operating requirements and its financing obligations when they come due. Our Company manages its liquidity profile through the efficient management of existing funds and effective planning for future funding requirements. Going forward, and to the extent it is able to do so, our Company intends to primarily use internally generated funds, money market instruments, bank overdrafts and bank loans to meet its financing requirements and if required, by borrowing of funds.

## **Credit Risk**

Credit risk is the risk that a counterparty will not meet its obligations under a financial instrument or customer contract, leading to a financial loss. Our Company is exposed to credit risk primarily from our operating activities (primarily trade receivables), including deposits with banks and financial institutions, foreign exchange transactions and other financial instruments. Trade receivables are typically unsecured. Credit risk is managed by our Company through credit approvals, establishing credit limits and continuously monitoring the creditworthiness of customers to which our Company grants credit terms in the normal course of business. Credit risk on cash and cash equivalent is limited as we generally transact with banks and financial institutions with high credit ratings assigned by international and domestic credit rating. In Fiscal 2019, 2020, and 2021, our trade receivables were ₹ 1,814.96 million, ₹ 1,276.72 million, and ₹ 1,708.01 million, respectively.

## **RELATED PARTY TRANSACTIONS**

Related party transactions with certain of our promoters and directors primarily relate to remuneration payable, loans advanced and issue of Equity Shares. For further details of such related parties under IND AS 24, see section titled “*Related Party Transactions*” on page 159.

### **Unusual or infrequent events or transactions**

As on date, there have been no unusual or infrequent events or transactions including unusual trends on account of business activity, unusual items of income, change of accounting policies and discretionary reduction of expenses.

### **Significant economic changes that materially affected or are likely to affect income from continuing operations**

Other than as described elsewhere in this chapter, the section “*Risk Factors*” and “*Industry Overview*” and the chapter “*Our Business*” beginning on pages 22, 95 and 111, respectively, there have been no significant economic changes that materially affected or are likely to affect our income from operations.

### **Known trends or uncertainties**

Other than as described elsewhere in this chapter, the section “*Risk Factors*” and the chapter “*Our Business*” on pages 22 and 111, respectively, to our knowledge, there are no known trends or uncertainties that are expected to have a material adverse impact on our revenues or income from continuing operations.

### **Future relationship between cost and revenue**

Other than as described elsewhere in this chapter, the section “*Risk Factors*” and the chapter “*Our Business*” beginning on pages 22 and 111, respectively, to our knowledge, there are no known factors that may adversely affect our business prospects, results of operations and financial condition.

### **Material increases in total income**

Changes in our revenues from operations in the last three Fiscals are as explained in the part “Fiscal 2020 compared to Fiscal 2019” and “Fiscal 2021 compared to Fiscal 2020” in this section.

### **Total turnover of each major industry segment in which the issuer operates**

The company is mainly engaged in the business of manufacturing and selling of machined / forged rings and auto components. The company’s business falls within a single business segment of ‘diversified auto components’ and all the activities of the Company revolve around the main business.

### **Competitive conditions**

We expect competition in our industry from existing and potential competitors to intensify. For details, see discussions of our competition in “*Our Business*” and “*Industry Overview*” on pages 111 and 95.

**Increase in income**

Increases in our income are due to the factors described above in “*Management’s Discussion and Analysis of Financial Condition and Results of Operations – Significant Factors Affecting Our Results of Operations*” and “*Risk Factors*” on pages 225 and 22, respectively.

**Status of any publicly announced new products or business segments**

Except as disclosed in the section titled “*Our Business*” on page 111, we have not announced and do not expect to announce in the near future any new products or business segments.

**Significant Dependence on a Single or Few Suppliers or Customers**

Other than as described elsewhere in this chapter, the section “*Risk Factors*” and the chapter “*Our Business*” beginning on pages 22 and 111, respectively, to our knowledge, there is no significant dependence on a single or few customers or suppliers.

**Seasonality of Business**

Our business is not affected by seasonal factors.

**Significant developments after March 31, 2021 that may affect our results of operations**

Except as set out in this Prospectus, no circumstances have arisen since the date of the last financial statements as disclosed in this Prospectus which materially or adversely affect or are likely to affect, our trading or profitability, or the value of our assets or our ability to pay our material liabilities within the next 12 months.



## CAPITALISATION STATEMENT

The following table sets forth our Company's capitalization as at March 31, 2021, as derived from our Restated Financial Statements. This table should be read in conjunction with the sections titled "Management's Discussion and Analysis of Financial Condition and Results of Operations", "Financial Statements" and "Risk Factors" beginning on pages 224, 161 and 22, respectively.

*(in ₹ million, except ratios)*

Particulars	Pre-offer as at March 31, 2021	As adjusted for the Offer
<b>Borrowings</b>		
Non-current borrowings (I)	323.45	323.45
Current maturity of long-term debts (II)	335.74	335.74
Short term borrowings (III)	1,835.72	1,835.72
<b>Total borrowings (IV = I + II + III)</b>	<b>2,494.91</b>	<b>2,494.91</b>
<b>Equity</b>		
Equity share capital (V)	239.81	246.03
Other Equity (VI)	3,327.52	3,881.30
<b>Total Equity (VII = V + VI)</b>	<b>3,567.33</b>	<b>4,127.33</b>
<b>Total borrowings/ Total Equity (VIII = IV/ VII)</b>	<b>0.70</b>	<b>0.60</b>

**Notes:**

- 1) *The above has been computed on the basis of amounts derived from the restated IndAS summary statement of assets and liabilities of the Company as on March 31, 2021.*
- 2) *As adjusted for the Offer column has only been adjusted for proceeds of Rs 560 million consisting of equity share capital of Rs 6.22 million and Securities premium of Rs 553.78 million considered in Equity Share Capital and Other Equity respectively. It does not consider any other adjustments.*
- 3) *Other Equity includes equity component of compound financial instruments.*
- 4) *Non-current borrowings includes liability component of compound financial instruments.*
- 5) *The Company has converted 2,630,000 OCRPS into 2,630,000 Equity Shares in the board meeting held on July 16, 2021. However, the same has not been adjusted in the above table.*

## SECTION VI – LEGAL AND OTHER INFORMATION

### OUTSTANDING LITIGATION AND MATERIAL DEVELOPMENTS

Except as stated in this section, there are no outstanding (i) criminal proceedings; (ii) actions taken by statutory or regulatory authorities; (iii) disciplinary action including penalty imposed by the SEBI or stock exchanges against our Promoter in the last five Fiscals, including outstanding action; (iv) claims related to direct and indirect taxes in a consolidated manner; and (v) details of any other pending material litigation which are determined to be material as per a policy adopted by our Board (“**Materiality Policy**”), in each case involving our Company, Promoter and Directors (the “**Relevant Parties**”).

For the purpose of (v) above, our Board in its meeting held on March 12, 2021, has considered and adopted a policy of materiality for identification of material litigation involving the Relevant Parties and Group Company.

In terms of the Materiality Policy, all pending litigation involving the Relevant Parties, other than criminal proceedings, actions by regulatory authorities and statutory authorities, disciplinary action including penalty imposed by SEBI or stock exchanges against our Promoter in the last five Fiscals including outstanding action and tax matters, would be considered ‘material’ for disclosure in this Prospectus:

(a) if the monetary amount of the claim exceeds the amount which is lesser of 1% of the total revenue, as per the Restated Financial Statements for Fiscal 2021 or 5% of the net worth, as per the Restated Financial Statements for Fiscal 2021;

(b) the decision in one case is likely to affect the decision in similar cases, even though the amount involved in an individual litigation may not exceed the amount which is lesser of 1% of the total revenue, as per Restated Financial Statements for Fiscal 2021 or 5% of the net worth, as per the Restated Financial Statements for Fiscal 2021; or

(c) all other outstanding litigation which may not meet the specific threshold and parameters as set out in (a) or (b) above, but where an adverse outcome would materially and adversely affect the business, operations or financial position or reputation of our Company.

Further, pre-litigation notices (other than those issued by governmental, statutory or regulatory authorities) received by any of the Relevant Parties or our Group Company shall not be considered as litigation until such time that any of the Relevant Parties or our Group Company, as the case may be, is made a party to proceedings initiated before any court, tribunal or governmental authority, or is notified by any governmental, statutory or regulatory authority or arbitral tribunal of any such proceeding that may be commenced.

Except as stated in this section, there are no outstanding litigation involving our Group Company which have a material impact on our Company.

Except as stated in this section, there are no outstanding material dues to creditors of our Company. For this purpose, our Board in its meeting held on March 12, 2021, has considered and adopted a policy of materiality for identification of material outstanding dues to creditors. In terms of this materiality policy, outstanding dues to any creditor of our Company having monetary value which exceeds ₹ 11.76 million, which is 1% of the trade payables of our Company as of March 31, 2021 as per the Restated Financial Statements of our Company included in this Prospectus, shall be considered as ‘material’.

Further, for outstanding dues to any party which is a micro, small or a medium enterprise (“**MSMEs**”), the disclosure will be based on information available with our Company regarding status of the creditor under section 2 of the Micro, Small and Medium Enterprises Development Act, 2006, as amended.

All terms defined in a particular litigation disclosure pertain to that litigation only. Unless stated to the contrary, the information provided below is as of the date of this Prospectus.

#### **I. Litigation involving our Company**

##### **A. Outstanding criminal proceedings involving our Company**

As on the date of this Prospectus, there are no outstanding criminal proceedings involving our Company.

**B. Action by statutory or regulatory authorities involving our Company**

As on the date of this Prospectus, there is no outstanding action by statutory or regulatory authorities involving our Company.

**C. Tax proceedings involving our Company**

Disclosed below are claims relating to direct and indirect taxes involving our Company, in a consolidated manner, giving details of the number of cases and liability involved in such claims:

Nature of tax involved	Number of cases outstanding	Amount involved in such proceedings (in ₹ million)
Direct tax	6	138.78
Indirect Tax	5	10.13
<b>Total</b>	<b>11</b>	<b>148.91</b>

**D. Other pending proceedings involving our Company**

As on the date of this Prospectus, there are no pending proceedings involving our Company, which have been considered material by our Company in accordance with the Materiality Policy.

**II. Litigation involving our Directors**

**A. Outstanding criminal proceedings involving our Directors**

As on the date of this Prospectus, there are no outstanding criminal proceedings involving our Directors.

**B. Pending action by statutory or regulatory authorities involving our Directors**

As on the date of this Prospectus, there are no pending actions by statutory or regulatory authorities against our Directors.

**C. Tax proceedings involving our Directors**

As on date of this Prospectus, there are no tax proceedings pending involving our Directors, except as stated below:

Nature of tax involved	Number of notices/case	Amount involved in such proceedings (in ₹ million)
Direct tax	5	Not quantifiable
<b>Total</b>	<b>5</b>	

**D. Material outstanding litigation involving our Directors**

As on the date of this Prospectus, there are no pending proceedings involving our Directors, which have been considered material by our Company in accordance with the Materiality Policy.

**III. Litigation involving our Promoters**

**A. Outstanding criminal proceedings involving our Promoters**

As on the date of this Prospectus, there are no outstanding criminal proceedings involving our Promoters.

**B. Pending action by statutory or regulatory authorities involving our Promoters**

As on the date of this Prospectus, there are no pending actions by statutory or regulatory authorities involving Promoter.

**C. Tax proceedings involving our Promoters**

As on the date of this Prospectus, there are no pending actions by taxation authorities involving our Promoters, except the notices received by our Promoters under sections 153C and 143(3) of the Income Tax Act, 1961, as stated below:

Nature of tax involved	Number of notices/case	Amount involved in such proceedings (in ₹ million)
Direct tax	10	Not quantifiable
<b>Total</b>	<b>10</b>	

**D. Material outstanding litigation involving our Promoters**

As on the date of this Prospectus, there are no pending proceedings involving our Promoters, which have been considered material by our Company in accordance with the Materiality Policy.

**E. Disciplinary action including penalty imposed by SEBI or stock exchanges against the Promoters in the last five financial years immediately preceding the date of filing of this Prospectus**

There has been no disciplinary action including penalty imposed by SEBI or stock exchanges against the Promoters in the last five financial years immediately preceding the date of filing of this Prospectus.

**IV. Litigation involving our Group Company which may have a material impact on our Company**

As on the date of this Prospectus, there is no outstanding material litigations involving our Group Company which may have a material impact on our Company.

**V. Outstanding dues to small scale undertakings or any other creditors**

In terms of the Materiality Policy, outstanding dues to any creditor of our Company having monetary value which exceeds ₹ 11.76 million, which is 1% of the trade payables of our Company as of March 31, 2021 as per the Restated Financial Statements of our Company included in this Prospectus, shall be considered as 'material'. As per the Restated Financial Statements, our total outstanding trade payables as of March 31, 2021 was ₹ 1,176.35 million. Accordingly, creditors to whom outstanding dues exceeds ₹ 11.76 million have been considered as material creditors for the purposes of disclosure in this Prospectus. As of March 31, 2021, our Company owed outstanding dues of ₹ 866.70 million to a total of thirteen material creditors.

Details of outstanding dues to MSMEs and other creditors as of March 31, 2021 by our Company is set out below:

Type of Creditor	Number of Creditors	Amount due (in ₹ million)
MSMEs	131	19.20
Material creditors	13	866.70
Other creditors	440	290.45
<b>Total</b>	<b>584</b>	<b>1,176.35</b>

The details pertaining to outstanding dues owed to our material creditors is available on the website of our Company at <http://www.rolexrings.com/>.

**VI. Material developments since the last balance sheet date**

Except as stated in “*Management’s Discussion and Analysis of Financial Condition and Results of Operation – Significant Developments after March 31, 2021*” on page 252, there have been no developments subsequent to March 31, 2021 that we believe are expected to have a material impact on the reserves, profits, earnings per share and book value of our Company.

## GOVERNMENT AND OTHER APPROVALS

*Except as disclosed herein, our Company has obtained all material consents, licenses, registrations, permissions and approvals from the relevant governmental, statutory and regulatory authorities, which are necessary for undertaking their business activities and operations. In the event any of the approvals and licenses that are required for our business operations expire in the ordinary course, we make applications for their renewal from time to time. We have set out below a list of material approvals, consents, licences and permissions from various governmental and regulatory authorities obtained by our Company which are considered material and necessary for the purpose of undertaking their business activities and operations. Unless otherwise stated, these material approvals are valid as on the date of this Prospectus. For details of risk associated with not obtaining or delay in obtaining the requisite approvals, see “Risk Factors - We may be unable to obtain, renew or maintain statutory and regulatory permits, licenses and approvals required to operate our business and operate our manufacturing facilities, which could have an adverse effect on our results of operations” on page 30. For further details in connection with the regulatory and legal framework within which we operate, see “Key Regulations and Policies in India” beginning on page 126. For incorporation details of our Company, see “History and Certain Corporate Matters” on page 131.*

### **Approvals in relation to our Company**

The approvals required to be obtained by our Company include the following:

#### **I. Incorporation details of our Company**

1. Partnership deed executed on April 26, 1988 under the name of ‘Rolex Industries’.
2. Certificate of incorporation dated February 13, 2003 issued by the RoC to our Company name of ‘Rolex Rings Private Limited’.
3. Fresh certificate of incorporation dated March 10, 2021 issued by the RoC to our Company consequent upon change of name on conversion to public limited company to Rolex Rings Limited.

#### **II. Approvals in relation to the Offer**

For details, see “Other Regulatory and Statutory Disclosures” and “The Offer” on pages 260 and 54, respectively.

#### **III. Approvals under tax laws of our Company**

- (a) Permanent account number AACCR3790B issued by the Income Tax Department under the Income Tax Act, 1961;
- (b) Professional tax registration under the Gujarat State Tax on Professions, Trades, Callings and Employment Act, 1976.
- (c) The goods and services tax registration number of our Company is 24AACCR3790B1ZO
- (d) The tax deduction and collection account number of our Company is RKTR00395D.

#### **IV. Employment and labour related Registrations**

- (a) Registration for employees’ provident fund issued by the Employees’ Provident Fund Organisation under the Employees’ Provident Funds and Miscellaneous Provisions Act, 1952; and
- (b) Certificate for contract labour issued by the Office of the Deputy Labour Department, under the Contract Labour (Regulation and Abolition) Act, 1970.

## **V. Material Approvals in relation to Business Operations of our Company**

As on date of this Prospectus, we operate three manufacturing units in Rajkot, Gujarat, India. In order to operate our business in India, our Company has procured following material approvals and/ or licenses, i.e., license to work a factory, consent to establish issued by the Gujarat Pollution Control Board under the Water (Prevention and Control of Pollution) Act 1974, Air (Prevention and Control of Pollution) Act 1981 and Hazardous and other Wastes (Management and Transboundary Movement) Rules, 2016, consolidated consent and authorisation issued by the Gujarat Pollution Control Board under the Water (Prevention and Control of Pollution) Act 1974, Air (Prevention and Control of Pollution) Act 1981 and Hazardous and other Wastes (Management and Transboundary Movement) Rules, 2016, certificate of importer-exporter code under the Foreign Trade (Development & Regulation) Act, 1992, license for the purchase, possession and use of methyl alcohol under the Bombay Prohibition Act, 1949 (as applicable), verification certificates for weighing equipment at our facilities under the Legal Metrology Act, 2009 and rules made thereunder and no objection certificate from the fire and emergency department of Rajkot.

Certain approvals may have lapsed in their normal course and our Company has either made applications to the appropriate authorities for renewal of such licenses and/or approvals or is in the process of making such applications.

### **Material Approvals applied for but not received**

- (a) Fire NOC for Unit I.
- (b) Fire NOC for Unit II & III.
- (c) License to work a factory for Unit I
- (d) License to work a factory for Unit II and III.

### **Material Approvals applicable but not applied for**

- (a) Nil

## OTHER REGULATORY AND STATUTORY DISCLOSURES

### Authority for this Offer

Our Board has authorised the Offer, pursuant to their resolution dated March 12, 2021 read with July 18, 2021. Our Shareholders have authorised the Offer pursuant to a special resolution passed at their extra-ordinary general meeting dated March 12, 2021. The Offer for Sale of 7,500,000 Equity Shares has been authorised by the Selling Shareholder (i.e. Rivendell PE LLC) pursuant to a resolution of its board of directors dated July 17, 2021 read with its consent letter dated July 17, 2021. Further, the Board has taken on record the Offer for Sale pursuant to its resolution dated July 18, 2021.

The Draft Prospectus has been approved by our Board pursuant to its resolution dated March 17, 2021.

This Prospectus has been approved by our Board pursuant to its resolution dated July 21, 2021.

Our Company has received in-principle approvals from the BSE and NSE for the listing of the Equity Shares pursuant to letters dated April 19, 2021 and May 4, 2021, respectively.

### Prohibition by SEBI or other Authorities

Our Company, Selling Shareholder (i.e. Rivendell PE LLC), Promoters, members of the Promoter Group, Directors, and the persons in control of our Company are not prohibited from accessing the capital markets or debarred from buying, selling or dealing in securities under any order or direction passed by SEBI or any securities market regulator in any other jurisdiction or any other authority/court.

### Compliance with the Companies (Significant Beneficial Ownership) Rules, 2018

Our Company, the Selling Shareholder (i.e. Rivendell PE LLC), our Promoters and members of our Promoter Group are in compliance with the Companies (Significant Beneficial Ownership) Rules, 2018, to the extent applicable, as on the date of this Prospectus.

### Directors associated with securities market

None of our Directors are associated with the securities market. There are no outstanding actions initiated by SEBI in the last five years against our Directors.

### Eligibility for the Offer

Our Company is eligible for the Offer in accordance with Regulation 6(1) of the SEBI ICDR Regulations as set out under the eligibility criteria calculated in accordance with the Restated Financial Statements prepared in accordance with the Companies Act and restated in accordance with the SEBI ICDR Regulations:

- a) Our Company has net tangible assets of at least ₹ 30 million in each of the preceding three full years (of 12 months each), of which not more than 50% of the net tangible assets are held as monetary assets;
- b) Our Company has a minimum average pre-tax operating profit of ₹150 million calculated on a restated and consolidated basis, during the preceding three years (of 12 months each), with operating profit in each of the preceding three years;
- c) Our Company has a net worth of at least ₹ 10 million in each of the three preceding full years (of 12 months each) calculated on a restated and consolidated basis; and
- d) Our Company has not changed its name within the last one year.

Our Company's operating profit, net worth, net tangible assets, monetary assets and monetary assets as a percentage of the net tangible assets derived from the Restated Financial Statements included in this Prospectus as at, and for the last three years ended March 31, are set forth below:

*(in ₹ million, except percentage values)*

Particulars	March 31, 2021	March 31, 2020	March 31, 2019
Net Tangible Assets (A)	3,881.41	3,238.14	2,644.65
Operating Profits	834.59	949.14	1,756.48
Net Worth	3,567.33	2,681.05	2,153.44

Particulars	March 31, 2021	March 31, 2020	March 31, 2019
Monetary Assets (B)	104.17	164.36	46.63
Monetary Assets as a percentage of Net Tangible Assets (B)/(A)(%)	2.68%	5.08%	1.76%

- i. Net tangible assets is the sum of all assets of our Company excluding intangible assets and right of use assets reduced by total liabilities excluding deferred tax liability (Net) of the Company.
- ii. Operating profit is defined as restated profit before tax excluding other income and finance expense.
- iii. Net worth has been computed as: aggregate value of the paid-up share capital and all reserves created out of the profits and securities premium account and debit or credit balance of profit and loss account, after deducting the aggregate value of the accumulated losses, deferred expenditure and miscellaneous expenditure not written off, as per the audited balance sheet, but does not include reserves created out of revaluation of assets, write-back of depreciation and amalgamation. Management has also considered equity component of compound financial statement above.
- iv. Monetary assets represent the sum of cash and cash equivalents and bank balances other than cash and cash equivalents (excludes Bank deposits with remaining maturity of more than twelve months).

Our Company confirms that it is in compliance with the conditions specified in Regulation 7(1) of the SEBI ICDR Regulations, to the extent applicable, and will ensure compliance with the conditions specified in Regulation 7(2) of the SEBI ICDR Regulations, to the extent applicable.

Our Company is in compliance with the following conditions specified under Regulations 5 of the SEBI ICDR Regulations:

- (i) Our Company, the Selling Shareholder (i.e. Rivendell PE LLC), our Promoters, the members of our Promoter Group, and our Directors are not debarred from accessing the capital markets;
- (ii) None of the Promoter or the Directors are promoter or directors of companies which are debarred from accessing the capital markets by SEBI;
- (iii) None of our Company, our Promoters or our Directors have been categorized as a Wilful Defaulter;
- (iv) None of our Promoters and our Directors are fugitive economic offenders; and
- (v) There are no outstanding warrants, options or rights to convert debentures, loans or other instruments convertible into, or which would entitle any person any option to receive Equity Shares, as on the date of this Prospectus.

The Selling Shareholder (i.e. Rivendell PE LLC) confirms that it is in compliance with Regulation 8 of the SEBI ICDR Regulations.

#### DISCLAIMER CLAUSE OF SEBI

**IT IS TO BE DISTINCTLY UNDERSTOOD THAT SUBMISSION OF THE DRAFT RED HERRING PROSPECTUS TO SEBI SHOULD NOT IN ANY WAY BE DEEMED OR CONSTRUED TO MEAN THAT THE SAME HAS BEEN CLEARED OR APPROVED BY SEBI. SEBI DOES NOT TAKE ANY RESPONSIBILITY EITHER FOR THE FINANCIAL SOUNDNESS OF ANY SCHEME OR THE PROJECT FOR WHICH THE OFFER IS PROPOSED TO BE MADE OR FOR THE CORRECTNESS OF THE STATEMENTS MADE OR OPINIONS EXPRESSED IN THE DRAFT RED HERRING PROSPECTUS. THE BOOK RUNNING LEAD MANAGERS, BEING EQUIRUS CAPITAL PRIVATE LIMITED, IDBI CAPITAL MARKETS & SECURITIES LIMITED AND JM FINANCIAL LIMITED HAVE CERTIFIED THAT THE DISCLOSURES MADE IN THE DRAFT RED HERRING PROSPECTUS ARE GENERALLY ADEQUATE AND ARE IN CONFORMITY WITH THE SECURITIES AND EXCHANGE BOARD OF INDIA (ISSUE OF CAPITAL AND DISCLOSURE REQUIREMENTS) REGULATIONS, 2018. THIS REQUIREMENT IS TO FACILITATE INVESTORS TO TAKE AN INFORMED DECISION FOR MAKING AN INVESTMENT IN THE PROPOSED OFFER.**

**IT SHOULD ALSO BE CLEARLY UNDERSTOOD THAT WHILE THE COMPANY IS PRIMARILY RESPONSIBLE FOR THE CORRECTNESS, ADEQUACY AND DISCLOSURE OF ALL RELEVANT INFORMATION IN THE DRAFT RED HERRING PROSPECTUS, THE SELLING SHAREHOLDER WILL BE RESPONSIBLE ONLY FOR THE STATEMENTS SPECIFICALLY CONFIRMED OR UNDERTAKEN BY IT IN THE DRAFT RED HERRING PROSPECTUS IN RELATION TO ITSELF FOR ITS RESPECTIVE PORTION OF OFFERED SHARES, THE BOOK RUNNING LEAD MANAGERS ARE EXPECTED TO EXERCISE DUE DILIGENCE TO ENSURE THAT THE**



**COMPANY AND THE SELLING SHAREHOLDER DISCHARGE THEIR RESPONSIBILITIES ADEQUATELY IN THIS BEHALF AND TOWARDS THIS PURPOSE, THE BOOK RUNNING LEAD MANAGERS HAVE FURNISHED TO SEBI, A DUE DILIGENCE CERTIFICATE DATED MARCH 17, 2021, IN THE FORMAT PRESCRIBED UNDER SCHEDULE V(A) OF THE SECURITIES AND EXCHANGE BOARD OF INDIA (ISSUE OF CAPITAL AND DISCLOSURE REQUIREMENTS) REGULATIONS, 2018.**

**THE FILING OF THE PROSPECTUS DOES NOT, HOWEVER, ABSOLVE OUR COMPANY FROM ANY LIABILITIES UNDER THE COMPANIES ACT, 2013 OR FROM THE REQUIREMENT OF OBTAINING SUCH STATUTORY OR OTHER CLEARANCES AS MAY BE REQUIRED FOR THE PURPOSE OF THE PROPOSED OFFER. SEBI FURTHER RESERVES THE RIGHT TO TAKE UP, AT ANY POINT OF TIME, WITH THE BOOK RUNNING LEAD MANAGERS ANY IRREGULARITIES OR LAPSES IN THE PROSPECTUS.**

**Disclaimer from our Company, the Selling Shareholder, our Directors and the BRLMs**

Our Company, the Selling Shareholder (i.e. Rivendell PE LLC), our Directors, the BRLMs accept no responsibility for statements made otherwise than those confirmed in this Prospectus or in the advertisements or any other material issued by or at our Company's instance. Anyone placing reliance on any other source of information, including our Company's website [www.rolexrings.com](http://www.rolexrings.com) or the website of the Selling Shareholder (i.e. Rivendell PE LLC), would be doing so at his or her or their own risk.

Unless required by law, the Selling Shareholder (i.e. Rivendell PE LLC), and where applicable, its respective directors, affiliates, associates and officers accept no responsibility for any statements and undertakings, except such statements and undertakings made or confirmed by them in this Prospectus specifically in relation to itself, and the Offered Shares, are true and correct.

The BRLMs accept no responsibility, save to the limited extent as provided in the Offer Agreement and the Underwriting Agreement to be entered into between the Underwriters, the Selling Shareholder (i.e. Rivendell PE LLC) and our Company.

All information shall be made available by our Company, Selling Shareholder (i.e. Rivendell PE LLC) and the BRLMs to the public and investors at large and no selective or additional information would be available for a section of the investors in any manner whatsoever, including at road show presentations, in research or sales reports, at Bidding centres or elsewhere.

None among our Company, the Selling Shareholder (i.e. Rivendell PE LLC) or any member of the Syndicate is liable for any failure in (i) uploading the Bids due to faults in any software/ hardware system or otherwise; and (ii) the blocking of Bid Amount in the ASBA Account on receipt of instructions from the Sponsor Bank on account of any errors, omissions or non-compliance by various parties involved in, or any other fault, malfunctioning or breakdown in, or otherwise, in the UPI Mechanism.

Investors who Bid in the Offer were required to confirm and were deemed to have represented to our Company, the Selling Shareholder (i.e. Rivendell PE LLC), BRLMs and their respective directors, officers, agents, affiliates, and representatives that they are eligible under all applicable laws, rules, regulations, guidelines and approvals to acquire the Equity Shares and will not issue, sell, pledge, or transfer the Equity Shares to any person who is not eligible under any applicable laws, rules, regulations, guidelines and approvals to acquire the Equity Shares. Our Company, the Selling Shareholder (i.e. Rivendell PE LLC), Underwriters and their respective directors, officers, agents, affiliates, and representatives accept no responsibility or liability for advising any investor on whether such investor is eligible to acquire the Equity Shares.

Neither the delivery of this Prospectus nor any offer or sale hereunder shall, under any circumstances, create any implication that there has been no change in the affairs of our Company and the Selling Shareholder (i.e. Rivendell PE LLC) from the date hereof or that the information contained herein is correct as of any time subsequent to this date.

The BRLMs and their respective associates and affiliates may engage in transactions with, and perform services for, our Company, the Selling Shareholder (i.e. Rivendell PE LLC) and their respective group companies, affiliates or associates or third parties in the ordinary course of business and have engaged, or may in the future engage, in commercial banking and investment banking transactions with our Company, the Selling Shareholder (i.e.

Rivendell PE LLC) and their respective group companies, affiliates or associates or third parties, for which they have received, and may in the future receive, compensation. As used herein, the term ‘affiliate’ means any person or entity that controls or is controlled by or is under common control with another person or entity.

### **Disclaimer in respect of Jurisdiction**

Any dispute arising out of this Offer will be subject to the jurisdiction of appropriate court(s) at Rajkot, India only.

### **Eligibility and Transfer Restrictions**

This Offer is being made in India to persons resident in India (including Indian nationals resident in India who are competent to contract under the Indian Contract Act, 1872, as amended, HUFs, companies, corporate bodies and societies registered under the applicable laws in India and authorised to invest in shares, domestic Mutual Funds registered with SEBI, Indian financial institutions, commercial banks, regional rural banks, co-operative banks (subject to permission from RBI), systemically important NBFCs or trusts under applicable trust law and who are authorised under their respective constitutions to hold and invest in shares, public financial institutions as specified in Section 2(72) of the Companies Act, 2013, multilateral and bilateral development financial institutions, state industrial development corporations, insurance companies registered with IRDAI, provident funds (subject to applicable law) and pension funds, National Investment Fund, insurance funds set up and managed by army, navy or air force of Union of India, insurance funds set up and managed by the Department of Posts, GoI, NBFC-SIs and permitted Non-Residents including FPIs and Eligible NRIs, AIFs, FVCIs, and other eligible foreign investors, if any, provided that they are eligible under all applicable laws and regulations to purchase the Equity Shares.

Bidders are advised to ensure that any Bid from them does not exceed investment limits or maximum number of Equity Shares that can be held by them under applicable law.

Invitations to subscribe to or purchase the Equity Shares in the Offer will be made only pursuant to this Prospectus if the recipient is in India or the preliminary offering memorandum for the Offer, which comprises this Prospectus and the preliminary international wrap for the Offer, if the recipient is outside India except the United States of America. No person outside India is eligible to Bid for Equity Shares in the Offer unless that person has received the preliminary offering memorandum for the Offer, which contains the selling restrictions for the Offer outside India.

No action has been taken to permit a public offering in any jurisdiction where action would be required for that purpose, except that this Prospectus has been filed with the RoC. Accordingly, the Equity Shares offered in the Offer may not be offered or sold, directly or indirectly, and this Prospectus may not be distributed in any jurisdiction, except in accordance with the legal requirements applicable in such jurisdiction. In particular, the Equity Shares offered in the Offer have not been and will not be registered under the U.S. Securities Act of 1933, as amended (the “**U.S. Securities Act**”), or the laws of any state of the United States and may not be offered or sold in the United States (as defined in Regulation S under the U.S. Securities Act (“**Regulation S**”)) except pursuant to an exemption from, or in a transaction not subject to, the registration requirements of the U.S. Securities Act and applicable state securities laws. The Equity Shares are being offered and sold only outside the United States pursuant to Regulation S.

Each purchaser of the Equity Shares offered in the Offer (referred to as “it” below) shall be deemed to have represented, warranted, agreed and acknowledged as follows:

- It understands that the Equity Shares offered in the Offer have not been and will not be registered under the U.S. Securities Act or the laws of any state of the United States and are being offered and sold to it in reliance on Regulation S.
- It was outside the United States at the time the offer of the Equity Shares offered in the Offer was made to it and it was outside the United States when its buy order for the Equity Shares offered in the Offer was originated.
- It did not purchase the Equity Shares offered in the Offer as a result of any “directed selling efforts” (as defined in Regulation S).
- It is buying the Equity Shares offered in the Offer for investment purposes and not with a view to the distribution thereof. If in the future it decides to offer, resell, pledge or otherwise transfer any of the Equity

Shares offered in the Offer, it agrees that it will not offer, sell, pledge or otherwise transfer the Equity Shares offered in the Offer except in transactions complying with Rule 903 or Rule 904 of Regulation S or pursuant to any other available exemption from registration under the U.S. Securities Act and in accordance with all applicable securities laws of the states of the United States and any other jurisdiction, including India.

- Where it is subscribing to the Equity Shares offered in the Offer as fiduciary or agent for one or more investor accounts, it has sole investment discretion with respect to each such account and it has full power to make the representations, warranties, agreements and acknowledgements herein.
- Where it is subscribing to the Equity Shares offered in the Offer for one or more managed accounts, it represents and warrants that it was authorised in writing by each such managed account to subscribe to the Equity Shares offered in the Offer for each managed account and to make (and it hereby makes) the representations, warranties, agreements and acknowledgements herein for and on behalf of each such account, reading the reference to “it” to include such accounts.
- It agrees to indemnify and hold our Company, the Selling Shareholder and the Members of the Syndicate harmless from any and all costs, claims, liabilities and expenses (including legal fees and expenses) arising out of or in connection with any breach of these representations, warranties or agreements. It agrees that the indemnity set forth in this paragraph shall survive the resale of the Equity Shares purchased in the Offer.
- It acknowledges that our Company, the Selling Shareholder, the Members of the Syndicate, their respective affiliates and others will rely upon the truth and accuracy of the foregoing representations, warranties, agreements and acknowledgements.

#### **Disclaimer Clause of BSE**

BSE Limited (“the Exchange”) has given vide its letter dated April 19, 2021 permission to this Company to use the Exchange’s name in this offer document as one of the stock exchanges on which this company’s securities are proposed to be listed. The Exchange has scrutinized this offer document for its limited internal purpose of deciding on the matter of granting the aforesaid permission to this Company. The Exchange does not in any manner:

- a) warrant, certify or endorse the correctness or completeness of any of the contents of this offer document; or
- b) warrant that this Company’s securities will be listed or will continue to be listed on the Exchange; or
- c) take any responsibility for the financial or other soundness of this Company, its promoters, its management or any scheme or project of this Company;

and it should not for any reason be deemed or construed that this offer document has been cleared or approved by the Exchange. Every person who desires to apply for or otherwise acquires any securities of this Company may do so pursuant to independent inquiry, investigation and analysis and shall not have any claim against the Exchange whatsoever by reason of any loss which may be suffered by such person consequent to or in connection with such subscription/acquisition whether by reason of anything stated or omitted to be stated herein or for any other reason whatsoever

#### **Disclaimer Clause of NSE**

As required, a copy of this Offer Document has been submitted to National Stock Exchange of India Limited (hereinafter referred to as NSE). NSE has given vide its letter Ref.: NSE/LIST/993 dated May 04, 2021 permission to the Issuer to use the Exchange’s name in this Offer Document as one of the Stock Exchanges on which this Issuer’s securities are proposed to be listed. The Exchange has scrutinized this draft offer document for its limited internal purpose of deciding on the matter of granting the aforesaid permission to this Issuer. It is to be distinctly understood that the aforesaid permission given by NSE should not in any way be deemed or construed that the offer document has been cleared or approved by NSE; nor does it in any manner warrant, certify or endorse the correctness or completeness of any of the contents of this offer document; nor does it warrant that this Issuer’s securities will be listed or will continue to be listed on the Exchange; nor does it take any responsibility for the financial or other soundness of this Issuer, its promoters, its management or any scheme or project of this Issuer. Every person who desires to apply for or otherwise acquire any securities of this Issuer may do so pursuant to independent inquiry, investigation and analysis and shall not have any claim against the Exchange whatsoever by reason of any loss which may be suffered by such person consequent to or in connection with such subscription /acquisition whether by reason of anything stated or omitted to be stated herein or any other reason whatsoever.

## **Listing**

The Equity Shares issued through this Prospectus are proposed to be listed on the BSE and NSE. Applications have been made to the Stock Exchanges for obtaining permission to deal in and for an official quotation of the Equity Shares to be issued and sold in the Offer. The NSE will be the Designated Stock Exchange with which the Basis of Allotment will be finalised.

If the permissions to deal in, and for an official quotation of, the Equity Shares are not granted by any of the Stock Exchanges mentioned above, our Company will forthwith repay, without interest, all monies received from the applicants in pursuance of this prospectus, in accordance with applicable law and the Selling Shareholder (i.e. Rivendell PE LLC) will be liable to reimburse our Company for any such repayment of monies, on its behalf, with respect to Selling Shareholder (i.e. Rivendell PE LLC) Offered Shares. If such money is not repaid within the prescribed time, then our Company, the Selling Shareholder (i.e. Rivendell PE LLC) and every officer in default shall be liable to repay the money, with interest, as prescribed under applicable law. Any expense incurred by our Company on behalf of the Selling Shareholder (i.e. Rivendell PE LLC) with regard to interest on such refunds will be reimbursed by the Selling Shareholder (i.e. Rivendell PE LLC). For the avoidance of doubt, subject to applicable law, the Selling Shareholder (i.e. Rivendell PE LLC) shall not be responsible to pay interest for any delay, except to the extent that such delay has been caused by any act or omission solely attributable to the Selling Shareholder (i.e. Rivendell PE LLC).

Our Company shall ensure that all steps for the completion of the necessary formalities for listing and commencement of trading of the Equity Shares at the Stock Exchanges are taken within six Working Days from the Bid/ Offer Closing Date or within such other period as may be prescribed. The Selling Shareholder (i.e. Rivendell PE LLC) confirms that it shall extend complete co-operation required by our Company and the BRLMs for the completion of the necessary formalities for listing and commencement of trading of the Equity Shares at the Stock Exchanges within six Working Days from the Bid/Offer Closing Date, or within such other period as may be prescribed.

If our Company does not Allot the Equity Shares within six Working Days from the Bid/ Offer Closing Date or within such timeline as prescribed by SEBI, all amounts received in the Public Offer Accounts will be transferred to the Refund Account and it shall be utilised to repay, without interest, all monies received from Bidders, failing which interest shall be due to be paid to the Bidders at the rate of 15% per annum for the delayed period, subject to applicable law.

## **Consents**

Consents in writing of (a) the Selling Shareholder (i.e. Rivendell PE LLC), our Directors, our Company Secretary and Compliance Officer, Chief Financial Officer, Statutory Auditor, the BRLMs, legal counsel, bankers/lenders to our Company, ICRA and the Registrar to the Offer, in their respective capacities have been obtained; and consents in writing of (b) the Syndicate Members, the Escrow Collection Bank(s), Public Offer Account Bank(s) the Sponsor Bank and Refund Bank(s) to act in their respective capacities, have been obtained and filed along with a copy of this Prospectus with the RoC as required under Sections 26 and 32 of the Companies Act, 2013. Further, consents received prior to filing of this Prospectus have not been withdrawn up to the time of delivery of this Prospectus with SEBI.

## **Expert to the Offer**

Except as stated herein, our Company has not obtained any expert opinions.

Our Company has received written consent dated August 3, 2021 from S R B C & Co LLP, Chartered Accountants, to include their name as required under section 26 (1) of the Companies Act, 2013 read with SEBI ICDR Regulations, in this Prospectus and as an “expert” as defined under section 2(38) of the Companies Act, 2013 to the extent and in their capacity as our Statutory Auditors, and in respect of their (i) examination report, dated July 18, 2021 on our Restated Financial Statements; and (ii) their report dated July 18, 2021 on the Statement of Special Tax Benefits in this Prospectus and such consent has not been withdrawn as on the date of this Prospectus. However, the term “expert” shall not be construed to mean an “expert” as defined under the U.S. Securities Act.

Additionally, our Company has also received a letter dated July 11, 2021 from Babulal A. Ughreja, Independent Chartered Engineer, to include their name as required under Section 26(5) of the Companies Act, 2013 read with SEBI ICDR Regulations, in this Prospectus as an “expert” as defined under Section 2(38) of the Companies Act,

2013.

### Public or rights issues by our Company during the last five years

Our Company has not made any public issue during the five years immediately preceding the date of this Prospectus. Except as mentioned below, our Company has not made any rights issue during the five years immediately preceding the date of this Prospectus.

Closing Date	Date of Allotment	Date of Refunds	Date of listing on stock exchanges	Premium/ discount amount (in ₹)
March 2, 2021	March 3, 2021	March 10, 2021	N.A.	N.A.

### Commission and brokerage paid on previous issues

Since this is an initial public offer of Equity Shares, no sum has been paid or has been payable as commission or brokerage for subscribing to or procuring or agreeing to procure subscription for any of the Equity Shares since our Company's incorporation.

### Capital issue during the previous three years by our Company, our listed Group Companies, subsidiaries and associates

Our Company does not have any subsidiaries or associates. Our Group Company is not listed on any stock exchange. For details in relation to the capital issuances by our Company in the three years preceding the date of filing this Prospectus, see "Capital Structure – Notes to Capital Structure" beginning on page 64.

### Performance vis-à-vis objects – our Company

Our Company has not made any public issue during the five years immediately preceding the date of this Prospectus. For details of rights issue made by our Company in the past five years, preceding the date of filing of this Prospectus, see "Capital Structure" beginning on page 64. Further, our Company has not experienced any shortfall or delays in the achievement of objects.

### Performance vis-à-vis objects – Last issue of Subsidiaries or Promoters

Our Company does not have any subsidiaries. Our Promoters being individuals do not have securities listed on any stock exchange.

- **Equirus Capital Private Limited**

1. Price information of past issues handled by Equirus:

Sr. No.	Issue Name	Issue Size (₹ million)	Issue Price (₹)	Listing Date	Opening Price on listing date	+/- % change in closing price, [+/- % change in closing benchmark]- 30th calendar days from listing	+/- % change in closing price, [+/- % change in closing benchmark]- 90th calendar days from listing	+/- % change in closing price, [+/- % change in closing benchmark]- 180th calendar days from listing
1.	Antony Waste Handling Cell Limited	2,999.85	315.00	January 01, 2021	436.10	-10.27% [-2.74%]	-23.21% [+4.80%]	2.14% [12.34%]
2.	G R Infraprojects Limited	9,623.34	837.00	July 19, 2021	1,715.85	N.A.	N.A.	N.A.

Source: [www.nseindia.com](http://www.nseindia.com) for price information and prospectus for issue details

Notes:

i. The S&P CNX NIFTY is considered as the Benchmark Index.

- ii. Price on NSE is considered for all of the above calculations.  
iii. In the event any day falls on a holiday, the price/index of the immediately preceding working day has been considered.  
iv. Not Applicable – Period not completed.

2. Summary statement of price information of past public issues handled by Equirus:

Financial Year	Total no. of IPOs	Total funds raised (₹ million)	Nos. of IPOs trading at discount as on 30th calendar day from listing date			Nos. of IPOs trading at premium as on 30th calendar day from listing date			Nos. of IPOs trading at discount as on 180th calendar day from listing date			Nos. of IPOs trading at premium as on 180th calendar day from listing date		
			Over 50%	Between 25%-50%	Less than 25%	Over 50%	Between 25%-50%	Less than 25%	Over 50%	Between 25%-50%	Less than 25%	Over 50%	Between 25%-50%	Less than 25%
2021 – 2022*	1	9,623.34	-	-	-	-	-	-	-	-	-	-	-	-
2020-2021	1	2,999.85	-	-	1	-	-	-	-	-	-	-	-	1
2019-2020	-	-	-	-	-	-	-	-	-	-	-	-	-	-

\* The information is as on the date of this Prospectus.

The information for each of the financial years is based on issues listed during such financial year.

• **IDBI Capital Markets & Securities Limited**

1. Price information of past issues handled by IDBI Capital:

Sr. No.	Issue Name	Issue Size (in Rs. Million)	Issue Price (Rs.)	Listing Date	Opening price on listing date	+/- % change in closing price, [+/- % change in closing benchmark] - 30th calendar days from listing	+/- % change in closing price, [+/- % change in closing benchmark] - 90th calendar days from listing	+/- % change in closing price, [+/- % change in closing benchmark] - 180th calendar days from listing
1.	RailTel Corporation of India Limited	8,192.42	94.00	February 26, 2021	109.00	+35.64% (-0.15%)	+37.50% (+5.32%)	N.A*
2.	Route Mobile Limited	6,000.00	350.00	September 21, 2020	717.00	+105.81% (+5.74%)	+231.04% (22.31%)	+347.33% (+31.05%)
3.	Indian Railway Catering and Tourism Corporation Limited	6,379.60	320.00 <sup>(2)</sup>	October 14, 2019	626.00	+191.27% (+2.10%)	+186.64% (+5.69%)	+291.84% (-21.43%)
4.	Rail Vikas Nigam Limited	4,768.61	19.00 <sup>(1)</sup>	April 11, 2019	19.00	+19.47% (-2.74%)	+40.26% (-0.35%)	+20.53% (-4.06%)

(1) Price for retail individual bidders bidding in the retail portion and to eligible employees was INR 18.50 per equity share

(2) Price for retail individual bidders bidding in the retail portion and to eligible employees was INR 310.00 per equity share

\*N.A: Not Available

**Notes:**

a. Source: www.nseindia.com for the price information

b. Wherever 30th/ 90th/ 180th calendar day from listing day is a holiday, the closing data of the previous trading day has been considered.

c. The Nifty 50 index is considered as the benchmark index.

1.1 Summary statement of price information of past issues handled by IDBI:

Fiscal	Total no. of IPOs	Total amount of funds raised (₹ in million)	No. of IPOs trading at discount as on 30 <sup>th</sup> calendar day from listing date			No. of IPOs trading at premium as on 30 <sup>th</sup> calendar day from listing date			No. of IPOs trading at discount as on 180 <sup>th</sup> calendar day from listing date			No. of IPOs trading at premium as on 180 <sup>th</sup> calendar day from listing date		
			Over 50%	Between 25%-50%	Less than 25%	Over 50%	Between 25%-50%	Less than 25%	Over 50%	Between 25%-50%	Less than 25%	Over 50%	Between 25%-50%	Less than 25%
2021 – 2022*	0	-	-	-	-	-	-	-	-	-	-	-	-	-
2020-2021	2	14,192.42	-	-	-	1	1	-	-	-	-	1	-	-
2019-2020	2	11,148.21	-	-	-	1	-	1	-	-	-	1	-	1

\* The information is as on the date of the document.

The information for each of the financial years is based on issues listed during such financial year.

• **JM Financial Limited**

**Price information of past issues handled by JM Financial Limited**

Price information of past issues (during the current Financial Year and two Financial Years preceding the current Financial Year) handled by JM Financial Limited.

Sr. No.	Issue name	Issue Size (million)	Issue price (₹)	Listing Date	Opening price on Listing Date (in ₹)	+/- % change in closing price, [+/- % change in closing benchmark] - 30 <sup>th</sup> calendar days from listing	+/- % change in closing price, [+/- % change in closing benchmark] - 90 <sup>th</sup> calendar days from listing	+/- % change in closing price, [+/- % change in closing benchmark] - 180 <sup>th</sup> calendar days from listing
1.	Tatva Chintan Pharma Chem Limited	5,000.00	1,083.00	July 29, 2021	2,111.85	Not Applicable	Not Applicable	Not Applicable
2.	Clean Science and Technology Limited	15,466.22	900.00	July 19, 2021	1,755	Not Applicable	Not Applicable	Not Applicable
3.	India Pesticides Limited	8,000.00	296.00	July 5, 2021	350.00	Not Applicable	Not Applicable	Not Applicable
4.	Shyam Metals and Energy Limited <sup>7</sup>	9,085.50	306.00	June 24, 2021	380.00	40.95% [0.42%]	Not Applicable	Not Applicable
5.	Sona BLW Precision Forgings Limited	55,500.00	291.00	June 24, 2021	301.00	45.45% [0.42%]	Not Applicable	Not Applicable
6.	Macrotech Developers Limited	25,000.00	486.00	April 19, 2021	436.00	30.22% [5.21%]	75.43% [10.89%]	Not Applicable
7.	Anupam Rasayan India Limited <sup>8</sup>	7,600.00	555.00	March 24, 2021	520.00	-0.11% [-0.98%]	30.49% [8.23%]	Not Applicable
8.	Easy Trip Planners Limited	5,100.00	187.00	March 19, 2021	212.25	-7.27% [-0.86%]	124.68% [6.94%]	Not Applicable
9.	MTAR Technologies Limited	5,964.14	575.00	March 15, 2021	1050.00	69.45% [-2.84%]	78.83% [5.83%]	Not Applicable
10.	Stove Kraft Limited	4,126.25	385.00	February 05, 2021	498.00	30.68% [0.09%]	28.92% [-2.05%]	Not Applicable

Source: www.nseindia.com for price information and prospectus/basis of allotment for issue details

Notes:

1. Opening price information as disclosed on the website of NSE.
2. Change in closing price over the issue/offer price as disclosed on NSE.
3. Change in closing price over the closing price as on the listing date for benchmark index viz. NIFTY 50.
4. In case of reporting dates falling on a trading holiday, values for the trading day immediately preceding the trading

holiday have been considered.

5. 30<sup>th</sup> calendar day has been taken as listing date plus 29 calendar days; 90<sup>th</sup> calendar day has been taken as listing date plus 89 calendar days; 180<sup>th</sup> calendar day has been taken a listing date plus 179 calendar days.
6. Restricted to last 10 issues.
7. A discount of 4.90 % on the Offer Price was offered to the Eligible Employees Bidding in the Employee Reservation Portion ( "Employee Discount" ) equivalent to ₹ 15 per Equity Share.
8. A discount of Rs. 55 per Equity Share was offered to Eligible Employees bidding in the Employee Reservation Portion.
9. Not Applicable - Period not completed

1. Summary statement of price information of past issues handled by JM Financial Limited:

Financial Year	Total no. of IPOs	Total funds raised ( Millions)	Nos. of IPOs trading at discount on as on 30 <sup>th</sup> calendar days from listing date			Nos. of IPOs trading at premium on as on 30 <sup>th</sup> calendar days from listing date			Nos. of IPOs trading at discount as on 180 <sup>th</sup> calendar days from listing date			Nos. of IPOs trading at premium as on 180 <sup>th</sup> calendar days from listing date		
			Over 50%	Between 25% - 50%	Less than 25%	Over 50%	Between 25%- 50%	Less than 25%	Over 50%	Between 25%- 50%	Less than 25%	Over 50%	Between 25%- 50%	Less than 25%
2021-2022	6	1,18,051.72	-	-	-	-	3	-	-	-	-	-	-	-
2020-2021	8	62,102.09	-	-	3	2	1	2	-	-	-	2	1	1
2019-2020	4	36,400.83**	-	-	1	-	1	2	-	1	1	-	1	1

\*\*Spandana Sphoorty Financial Limited raised Rs. 11,898.49 million as against the issue size of Rs. 12,009.36 million

### Track record of past issues handled by the BRLMs

For details regarding the track record of the BRLMs, as specified in circular reference CIR/MIRSD/1/2012 dated January 10, 2012 issued by SEBI, please see the websites of the BRLMs, as set forth in the table below:

Sr. No	Name of the BRLM	Website
1.	Equirus Capital Private Limited	www.equirus.com
2.	IDBI Capital Markets & Securities Limited	www.idbicapital.com
3.	JM Financial Limited	www.jmfl.com

### Stock Market Data of Equity Shares

This being an initial public offer of our Company, the Equity Shares are not listed on any stock exchange and accordingly, no stock market data is available for the Equity Shares.

### Mechanism for Redressal of Investor Grievances

The agreement between the Registrar to the Offer, our Company and the Selling Shareholder (i.e. Rivendell PE LLC) provides for retention of records with the Registrar to the Offer for a period of at least eight years from the last date of dispatch of the letters of allotment and demat credit to enable the investors to approach the Registrar to the Offer for redressal of their grievances.

All grievances in relation to the Bidding process may be addressed to the Registrar to the Offer with a copy to the relevant Designated Intermediary to whom the Bid cum Application Form was submitted. The Bidder should give full details such as name of the sole or First Bidder, Bid cum Application Form number, Bidder DP ID, Client ID, UPI ID, PAN, date of the submission of Bid cum Application Form, address of the Bidder, number of the Equity Shares applied for and the name and address of the Designated Intermediary where the Bid cum Application Form was submitted by the Bidder. Anchor Investors are required to address all grievances in relation to the Offer to the BRLMs. Further, the Bidder shall also enclose a copy of the Acknowledgment Slip duly received from the concerned Designated Intermediary in addition to the information mentioned hereinabove.



The Registrar to the Offer shall obtain the required information from the SCSBs for addressing any clarifications or grievances of ASBA Bidders.

Our Company, the BRLMs and the Registrar to the Offer accept no responsibility for errors, omissions, commission or any acts of SCSBs including any defaults in complying with their obligations under applicable SEBI ICDR Regulations.

Investors can contact the Compliance Officer or the Registrar to the Offer in case of any pre-Offer or post-Offer related problems such as non-receipt of letters of Allotment, non-credit of allotted Equity Shares in the respective beneficiary account, non-receipt of refund intimations and non-receipt of funds by electronic mode.

In terms of SEBI circular no. SEBI/HO/CFD/DIL2/CIR/P/2018/22, dated February 15, 2018, SEBI circular SEBI/HO/CFD/DIL2/CIR/P/2021/2480/1/M dated March 16, 2021, as amended pursuant to SEBI circular SEBI/HO/CFD/DIL2/P/CIR/2021/570 dated June 2, 2021 and subject to applicable law, any ASBA Bidder whose Bid has not been considered for Allotment, due to failure on the part of any SCSB, shall have the option to seek redressal of the same by the concerned SCSB within three months of the date of listing of the Equity Shares. SCSBs are required to resolve these complaints within 15 days, failing which the concerned SCSB would have to pay interest at the rate of 15% per annum for any delay beyond this period of 15 days. Further, the investors shall be compensated by the SCSBs in accordance with SEBI circular SEBI/HO/CFD/DIL2/CIR/P/2021/2480/1/M dated March 16, 2021 in the events of delayed unblock for cancelled/withdrawn/deleted applications, blocking of multiple amounts for the same UPI application, blocking of more amount than the application amount, delayed unblocking of amounts for non-allotted/partially-allotted applications, for the stipulated period. In an event there is a delay in redressal of the investor grievance in relation to unblocking of amounts, the Book Running Lead Managers shall compensate the investors at the rate higher of ₹ 100 or 15% per annum of the application amount for the period of such delay.

Our Company has obtained authentication on the SCORES and shall comply with the SEBI circular no.CIR/OIAE/1/2013 dated April 17, 2013 and SEBI circular (CIR/OIAE/1/2014) dated December 18, 2014 in relation to redressal of investor grievances through SCORES.

Our Company has constituted a Stakeholders' Relationship Committee. For details, see "*Our Management*" on page 136.

Our Company has appointed Hardik Dhimantbhai Gandhi as our Company Secretary and Compliance Officer for the Company who may be contacted in case of any pre-Offer or post-Offer related grievances. His contact details are as follows:

B/h. Glowtech Steel Private Limited,  
Gondal Road, Kotharia,  
Rajkot – 360004, Gujarat  
**Tel:** 0281 6699677/577  
**E-mail:** compliance@rolexrings.com

The Selling Shareholder (i.e. Rivendell PE LLC) has authorised the Company Secretary and Compliance Officer of the Company, and the Registrar to the Offer to redress any complaints received from Bidders in respect of the Offer for Sale.

Our Company has not received any investor complaint during the three years preceding the date of this Prospectus. Further, no investor complaint in relation to our Company is pending as on the date of this Prospectus.

**Disposal of Investor Grievances by our Company**

Our Company estimates that the average time required by our Company or the Registrar to the Offer or the SCSB in case of ASBA Bidders, for the redressal of routine investor grievances shall be 10 Working Days from the date of receipt of the complaint. In case of non-routine complaints and complaints where external agencies are involved, our Company will seek to redress these complaints as expeditiously as possible.

## SECTION VII – OFFER INFORMATION

### TERMS OF THE OFFER

The Equity Shares being issued, offered and Allotted pursuant to the Offer shall be subject to the provisions of the Companies Act, SEBI ICDR Regulations, SCRA, SCRR, the MoA, AoA, Listing Regulations, the terms of the Red Herring Prospectus, this Prospectus, the abridged prospectus, Bid cum Application Form, the Revision Form, the CAN/Allotment Advice and other terms and conditions as may be incorporated in other documents/certificates that may be executed in respect of the Offer. The Equity Shares shall also be subject to laws as applicable, guidelines, rules, notifications and regulations relating to the issue of capital and listing and trading of securities issued from time to time by SEBI, the Government of India, the Stock Exchanges, the RBI, RoC and/or other authorities, as in force on the date of the Offer and to the extent applicable or such other conditions as may be prescribed by the SEBI, the Government of India, the Stock Exchanges, the RoC and/or any other authorities while granting its approval for the Offer.

The Allottees upon Allotment of Equity Shares under the Offer will be entitled to dividend and other corporate benefits, if any, declared by our Company after the date of Allotment. The Equity Shares issued in the Offer shall be *pari passu* with the existing Equity Shares in all respects including dividends. For further details, see “*Main Provisions of Articles of Association*” on page 299.

#### Mode of Payment of Dividend

Our Company shall pay dividends, if declared, to the Shareholders in accordance with the provisions of the Companies Act, the Memorandum and Articles of Association and provisions of the Listing Regulations and any other guidelines or directions which may be issued by the Government in this regard. Dividends, if any, declared by our Company after the date of Allotment (pursuant to the transfer of Equity Shares from the Offer for Sale), will be payable to the Bidders who have been Allotted Equity Shares in the Offer, for the entire year, in accordance with applicable laws. For further details, in relation to dividends, see “*Dividend Policy*” and “*Main Provisions of Articles of Association*” beginning on pages 160 and 299, respectively.

#### Face Value, Offer Price, Floor Price and Price Band

The face value of each Equity Share is ₹10 and the Offer Price at the lower end of the Price Band is ₹880 per Equity Share and at the higher end of the Price Band is ₹900 per Equity Share. The Anchor Investor Offer Price is ₹900 per Equity Share. The Price Band and the minimum Bid Lot size for the Offer will be decided by our Company and the Selling Shareholder (i.e. Rivendell PE LLC) in consultation with the BRLMs, and advertised in all editions of Financial Express, an English national daily newspaper, all editions of Jansatta, a Hindi national daily newspaper and Rajkot editions of Jaihind, a Gujarati newspaper, Gujarati being the regional language of Gujarat, where our Registered Office is located, each with wide circulation, at least two Working Days prior to the Bid/Offer Opening Date and shall be made available to the Stock Exchanges for the purpose of uploading the same on their websites. The Price Band, along with the relevant financial ratios calculated at the Floor Price and at the Cap Price, shall be pre-filled in the Bid cum Application Forms available on the respective websites of the Stock Exchanges. At any given point of time, there shall be only one denomination for the Equity Shares.

#### The Offer

The Offer consists of a Fresh Issue by our Company and an Offer for Sale by the Selling Shareholder (i.e. Rivendell PE LLC). The Offer-related expenses shall be shared between our Company and the Selling Shareholder (i.e. Rivendell PE LLC) in proportion of the size of the Fresh Issue and the Offer for Sale respectively. All Offer-related expenses shall initially be borne by the Company. Upon successful completion of the Offer, the Selling Shareholder (i.e. Rivendell PE LLC) shall reimburse the Company its proportionate share of the Offer-related expenses.

#### Rights of the Equity Shareholders

Subject to applicable laws, rules, regulations and guidelines and the Articles of Association, our equity Shareholders shall have the following rights:

- Right to receive dividends, if declared;

- Right to attend general meetings and exercise voting rights, unless prohibited by law;
- Right to vote on a poll either in person or by proxy, in accordance with the provisions of the Companies Act;
- Right to receive offers for rights shares and be allotted bonus shares, if announced;
- Right to receive surplus on liquidation, subject to any statutory and preferential claim being satisfied;
- Right of free transferability, subject to applicable laws including any RBI rules and regulations; and
- Such other rights, as may be available to a shareholder of a listed public company under the Companies Act, the SEBI Listing Regulations and the Articles of Association of our Company.

For a detailed description of the main provisions of the Articles of Association of our Company relating to voting rights, dividend, forfeiture and lien, transfer, transmission and/or consolidation/splitting, see “*Main Provisions of Articles of Association*” beginning on page 299.

#### **Allotment only in dematerialised form**

Pursuant to Section 29 of the Companies Act, 2013 the Equity Shares shall be Allotted only in dematerialised form. As per the SEBI ICDR Regulations, the trading of the Equity Shares shall only be in dematerialised form on the Stock Exchanges. In this context, our Company has entered into the following agreements with the respective Depositories and Registrar to the Offer:

- Tripartite agreement dated June 16, 2015 amongst our Company, NSDL and Registrar to the Offer.
- Tripartite agreement dated April 16, 2015 amongst our Company, CDSL and Registrar to the Offer.

#### **Market Lot and Trading Lot**

Since trading of the Equity Shares is in dematerialised form, the tradable lot is one Equity Share. Allotment in his Offer will be in multiples of one Equity Share subject to a minimum Allotment of 16 Equity Shares.

#### **Joint Holders**

Subject to the provisions of the Articles of Association, where two or more persons are registered as the holders of the Equity Shares, they will be deemed to hold such Equity Shares as joint tenants with benefits of survivorship.

#### **Nomination facility to investors**

In accordance with Section 72 of the Companies Act, 2013, read with the Companies (Share Capital and Debentures) Rules, 2014, the sole Bidder, or the first Bidder along with other joint Bidders, may nominate any one person in whom, in the event of the death of sole Bidder or in case of joint Bidders, death of all the Bidders, as the case may be, the Equity Shares Allotted, if any, shall vest. A person, being a nominee, entitled to the Equity Shares by reason of the death of the original holder(s), shall be entitled to the same advantages to which he or she would be entitled if he or she were the registered holder of the Equity Share(s). Where the nominee is a minor, the holder(s) may make a nomination to appoint, in the prescribed manner, any person to become entitled to Equity Share(s) in the event of his or her death during the minority. A nomination shall stand rescinded upon a sale/transfer/alienation of Equity Share(s) by the person nominating. A buyer will be entitled to make a fresh nomination in the manner prescribed. Fresh nomination can be made only on the prescribed form available on request at our Registered Office or to the registrar and transfer agents of our Company.

Any person who becomes a nominee by virtue of the provisions of Section 72 of the Companies Act, 2013 shall upon the production of such evidence as may be required by the Board, elect either:

- a) to register himself or herself as the holder of the Equity Shares; or
- b) to make such transfer of the Equity Shares, as the deceased holder could have made.

Further, the Board may at any time give notice requiring any nominee to choose either to be registered himself or herself or to transfer the Equity Shares, and if the notice is not complied with within a period of 90 days, the Board may thereafter withhold payment of all dividends, bonuses or other monies payable in respect of the Equity Shares, until the requirements of the notice have been complied with. Since the Allotment of Equity Shares in the Offer will be made only in dematerialized mode, there is no need to make a separate nomination with our Company. Nominations registered with respective Depository Participant of the Bidder would prevail. If the Bidder wants to

change the nomination, they are requested to inform their respective Depository Participant. Our Company shall comply with such disclosure and accounting norms as may be specified by SEBI from time to time.

### **Bid/Offer Programme**

<b>BID/ OFFER OPENED ON*</b>	<b>Wednesday, July 28, 2021</b>
<b>BID/ OFFER CLOSED ON**§</b>	<b>Friday, July 30, 2021</b>

\* The Anchor Investor Bid/ Offer Period was one Working Day prior to the Bid/ Offer Opening Date i.e. July 27,2021.  
 § The UPI mandate end time and date shall be 12 P.M. on Monday, August 2, 2021.

In case of (i) any delay in unblocking of amounts in the ASBA Accounts (including amounts blocked through the UPI Mechanism) for cancelled/ withdrawn/ deleted ASBA Forms, the Bidders shall be compensated by the SCSB responsible for causing such delay in unblocking at a uniform rate of ₹100 per day or 15% per annum of the Bid Amount, whichever is higher from the date on which the request for cancellation/ withdrawal/ deletion is placed in the Stock Exchanges bidding platform until the date on which the amounts are unblocked; (ii) any blocking of multiple amounts for the same ASBA Form (for amounts blocked through the UPI Mechanism), the Bidder shall be compensated by the SCSB responsible for causing such delay in unblocking at a uniform rate ₹100 per day or 15% per annum of the total cumulative blocked amount except the original application amount, whichever is higher from the date on which such multiple amounts were blocked till the date of actual unblock; (iii) any blocking of amounts more than the Bid Amount, the Bidder shall be compensated at a uniform rate of ₹100 per day or 15% per annum of the difference in amount, whichever is higher from the date on which such excess amounts were blocked till the date of actual unblock; (iv) any delay in unblocking of non-allotted/ partially allotted Bids, exceeding four Working Days from the Bid/Offer Closing Date, the Bidder shall be compensated by the SCSB responsible for causing such delay in unblocking at a uniform rate of ₹100 per day or 15% per annum of the Bid Amount, whichever is higher for the entire duration of delay exceeding four Working Days from the Bid/Offer Closing Date by the SCSB responsible for causing such delay in unblocking. The post Offer BRLMs shall be liable for compensating the Bidder at a uniform rate of ₹100 per day or 15% per annum of the Bid Amount, whichever is higher from the date of receipt of the Investor grievance until the date on which the blocked amounts are unblocked.

An indicative timetable in respect of the Offer is set out below:

<b>Event</b>	<b>Indicative Date</b>
Finalisation of Basis of Allotment with the Designated Stock Exchange	On or about Wednesday, 4 August, 2021
Initiation of refunds (if any, for Anchor Investors) / unblocking of funds from ASBA Account*	On or about Thursday, 5 August, 2021
Credit of the Equity Shares to depository accounts of Allottees	On or about Friday, 6 August, 2021
Commencement of trading of the Equity Shares on the Stock Exchanges	On or about Monday, 9 August, 2021

\*In case of any delay in unblocking of amounts in the ASBA Accounts (including amounts blocked through the UPI Mechanism) exceeding four Working Days from the Bid/Offer Closing Date, the Bidder shall be compensated by the SCSB responsible for causing such delay in unblocking at a uniform rate of ₹100 per day for the entire duration of delay exceeding four Working Days from the Bid/Offer Closing Date by the intermediary responsible for causing such delay in unblocking. The BRLMs shall, in their sole discretion, identify and fix the liability on such intermediary or entity responsible for such delay in unblocking. The Bidder shall be compensated in the manner specified in the SEBI circular no. SEBI/HO/CFD/DIL1/CIR/P/2021/47 dated March 31, 2021 and SEBI circular no. SEBI/HO/CFD/DIL2/CIR/P/2021/2480/1/M dated March 16, 2021, as amended pursuant to SEBI circular no. SEBI/HO/CFD/DIL2/P/CIR/2021/570 dated June 2, 2021, which for the avoidance of doubt, shall be deemed to be incorporated in the deemed agreement of the Company with the SCSBs, to the extent applicable.

For helpline details of the BRLMs, Sponsor Bank and the Registrar to the Offer pursuant to the SEBI/HO/CFD/DIL2/CIR/P/2021/2480/1/M dated March 16, 2021, see “General Information” on page 56.

**The above timetable, other than the Bid/Offer Closing Date, is indicative and does not constitute any obligation or liability on our Company, our Selling Shareholder (i.e. Rivendell PE LLC) or the BRLMs.**

Whilst our Company shall ensure that all steps for the completion of the necessary formalities for the listing and the commencement of trading of the Equity Shares on the Stock Exchanges are taken within six Working Days of the Bid/Offer Closing Date, the timetable may be extended due to various factors, such as extension of the Bid/Offer Period by our Company and the Selling Shareholder (i.e. Rivendell PE LLC) in consultation with the BRLMs, revision of the Price Band or any delay in receiving the final listing and trading approval from the Stock Exchanges. The commencement of trading of the Equity Shares will be entirely at the discretion of the Stock Exchanges and in accordance with the applicable laws. The Selling Shareholder (i.e. Rivendell PE LLC) confirms that it shall extend such reasonable support and co-operation required by our Company and the BRLMs for completion of the necessary formalities for listing and commencement of trading of the Equity Shares at the Stock Exchanges within six Working Days from the Bid/Offer Closing Date or such other period as may be prescribed by SEBI.

**Submission of Bids (other than Bids from Anchor Investors):**

<b>Bid/ Offer Period (except the Bid/ Offer Closing Date)</b>	
Submission and Revision in Bids	Only between 10:00 am and 5:00 pm (Indian Standard Time (“IST”))
<b>Bid/ Offer Closing Date</b>	
Submission and Revision in Bids	Only between 10:00 am and 3:00 pm IST

\* UPI mandate end time and date shall be at 12 P.M. on Monday, August 2, 2021.

#### **On the Bid/ Offer Closing Date:**

- (i) In case of Bids by QIBs and Non-Institutional Bidders, the Bids and the revisions in Bids were accepted only between 10.00 a.m. and 3.00 p.m.(IST) and uploaded by 4.00 p.m. IST, and
- (ii) In case of Bids by Retail Individual Bidders, the Bids and the revisions in Bids were accepted only between 10.00 a.m. and 3.00 p.m. (IST) and uploaded until 5.00 p.m. IST or such extended time as permitted by the Stock Exchanges, in case of Bids by RIBs.

On Bid/Offer Closing Date, extension of time may be granted by Stock Exchanges only for uploading Bids received by Retail Individual Bidders, after taking into account the total number of Bids received and as reported by the BRLMs to the Stock Exchanges.

**It is clarified that Bids not uploaded on the electronic bidding system or in respect of which the full Bid Amount is not blocked by SCSBs or not blocked under the UPI Mechanism in the relevant ASBA Account, as the case may be would be rejected.**

Due to limitation of time available for uploading the Bids on the Bid/Offer Closing Date, Bidders were advised to submit their Bids one day prior to the Bid/Offer Closing Date. Any time mentioned in this Prospectus is IST. Bidders were cautioned that, in the event a large number of Bids were received on the Bid/Offer Closing Date, some Bids may not get uploaded due to lack of sufficient time. Such Bids that cannot be uploaded will not be considered for allocation under this Offer. Bids will be accepted only during Working Days.

Investors may please note that as per letter no. List/SMD/SM/2006 dated July 3, 2006 and letter no. NSE/IPO/25101-6 dated July 6, 2006 issued by BSE and NSE respectively, Bids and any revision in Bids shall not be accepted on Saturdays and public holidays as declared by the Stock Exchanges. Bids by ASBA Bidders shall be uploaded by the relevant Designated Intermediary in the electronic system to be provided by the Stock Exchanges. None among our Company and the Selling Shareholder (i.e. Rivendell PE LLC) or any member of the Syndicate is liable for any failure in (i) uploading the Bids due to faults in any software/ hardware system or otherwise; and (ii) the blocking of Bid Amount in the ASBA Account on receipt of instructions from the Sponsor Bank on account of any errors, omissions or non-compliance by various parties involved in, or any other fault, malfunctioning or breakdown in, or otherwise, in the UPI Mechanism.

Our Company and the Selling Shareholder (i.e. Rivendell PE LLC), in consultation with the BRLMs reserves the right to revise the Price Band during the Bid/Offer Period. The revision in the Price Band shall not exceed 20% on either side, i.e. the Floor Price can move up or down to the extent of 20% of the Floor Price and the Cap Price will be revised accordingly.

**In case of revision in the Price Band, the Bid/Offer Period shall be extended for at least three additional Working Days after such revision, subject to the Bid/Offer Period not exceeding 10 Working Days. In cases of force majeure, banking strike or similar circumstances, our Company and the Selling Shareholder (i.e. Rivendell PE LLC) in consultation with the BRLMs, for reasons to be recorded in writing, extend the Bid/Offer Period for a minimum of three Working Days, subject to the Bid/ Offer Period not exceeding 10 Working Days. Any revision in Price Band, and the revised Bid/Offer Period, if applicable, shall be widely disseminated by notification to the Stock Exchanges, by issuing a press release and also by indicating the change on the terminals of the Syndicate Members and by intimation to the Designated Intermediaries.**

In case of discrepancy in data entered in the electronic book vis-vis data contained in the Bid cum Application Form for a particular Bidder, the details as per the Bid file received from the Stock Exchanges shall be taken as the final data for the purpose of Allotment.

#### **Minimum Subscription**

If our Company does not receive the minimum subscription in the Offer as specified under Rule 19(2)(b) of the SCRR), including through devolvement of Underwriters, as applicable, within 60 days from the date of Bid/ Offer Closing Date on the date of closure of the Offer or; the minimum subscription of 90% of the Fresh Issue on the date of closure of the Offer; or withdrawal of applications; or after technical rejections; or if the listing or trading permission is not obtained from the Stock Exchanges for the Equity Shares so offered under the offer document, our Company shall forthwith refund the entire subscription amount received. If there is a delay beyond fifteen days after our Company becomes liable to pay the amount, our Company and our Directors, who are officers in default, shall pay interest at the rate of 15% per annum. In the event of an undersubscription in the Offer, Equity Shares offered pursuant to the Fresh Issue shall be allocated in the Fresh Issue prior to the Equity Shares offered pursuant to the Offer for Sale.

The Selling Shareholder (i.e. Rivendell PE LLC) shall reimburse, in proportion to the respective portion of its Offered Shares, any expenses and interest incurred by our Company on behalf of it for any delays in making refunds as required under the Companies Act and any other applicable law, provided that the Selling Shareholder (i.e. Rivendell PE LLC) shall not be responsible or liable for payment of such expenses or interest, unless such delay is solely and directly attributable to an act or omission of the Selling Shareholder (i.e. Rivendell PE LLC).

Further, in terms of Regulation 49(1) of the SEBI ICDR Regulations, our Company shall ensure that the number of Bidders to whom the Equity Shares will be Allotted will be not less than 1,000.

#### **Arrangements for Disposal of Odd Lots**

There are no arrangements for disposal of odd lots since our Equity Shares will be traded in dematerialised form only and market lot for our Equity Shares will be one Equity Share.

#### **Restrictions, if any on Transfer and Transmission of Equity Shares**

Except for lock-in of the pre-Offer capital of our Company as well as shares held by Promoters and certain members of the Promoter Group which are subject to pledge in accordance with the provisions of the CDR Package, lock-in of the Promoters' minimum contribution under the SEBI ICDR Regulations and the Anchor Investor lock-in as provided in "*Capital Structure*" on page 64 and except as provided under the Articles of Association, there are no restrictions on transfer of the Equity Shares. Further, there are no restrictions on transmission of any shares of our Company and on their consolidation or splitting, except as provided in the Articles of Association. For details, see "*Main Provisions of Articles of Association*" beginning on page 299.

## OFFER STRUCTURE

Initial public offering of 8,122,222 Equity Shares for cash at a price of ₹ 900 per Equity Share (including a share premium of ₹ 890 per Equity Share) aggregating to ₹ 7,310 million (the “Offer”). The Offer comprises of a Fresh Issue of 622,222 Equity Shares aggregating to ₹ 560 million and an Offer for Sale of 7,500,000 Equity Shares aggregating to ₹ 6,750 million. The Offer shall constitute 29.82%, of the post-offer paid-up Equity Share capital of our Company.

The Offer is being made through the Book Building Process.

Particulars	QIBs <sup>(1)</sup>	Non-Institutional Bidders	Retail Individual Bidders
Number of Equity Shares available for Allotment/ allocation <sup>(2)</sup>	4,061,110 Equity Shares	1,218,334 Equity Shares	2,842,778 Equity Shares
Percentage of Offer size available for Allotment/ allocation	Not more than 50% of the Offer was made available for allocation to QIBs. However, 5% of the QIB Portion (excluding the Anchor Investor Portion) was available for allocation proportionately to Mutual Funds only. Mutual Funds participating in the Mutual Fund Portion were also eligible for allocation in the remaining balance QIB Portion (excluding the Anchor Investor Portion). The unsubscribed portion in the Mutual Fund Portion was made available for allocation to other QIBs	Not less than 15% of the Offer or the Offer less allocation to QIBs and Retail Individual Bidders will be available for allocation	Not less than 35% of the Offer or Offer less allocation to QIBs and Non-Institutional Bidders will be available for allocation
Basis of Allotment if respective category is oversubscribed*	Proportionate as follows (excluding the Anchor Investor Portion):  (a) 81,223 Equity Shares were made available for allocation on a proportionate basis to Mutual Funds; and  (b) 1,543,221 Equity Shares shall be Allotted on a proportionate basis to all QIBs including Mutual Funds receiving allocation as per (a) above.  Our Company and the Selling Shareholder (i.e. Rivendell PE LLC) in consultation with the BRLMs, may allocate up to 60% of the QIB Portion to Anchor Investors at the Anchor Investor Allocation Price on a discretionary basis, out of which at least one-third will be available for allocation to domestic Mutual Funds only.	Proportionate.	Allotment to each Retail Individual Bidders shall not be less than the minimum Bid Lot, subject to availability of Equity Shares in the Retail Portion, and the remaining available Equity Shares, if any, shall be allotted on a proportionate basis. For further details, see the General Information Document.
Minimum Bid	Such number of Equity Shares so that the Bid Amount exceeds ₹ 200,000 and in multiples of 16 Equity Shares thereafter.	Such number of Equity Shares so that the Bid Amount exceeds ₹ 200,000 and in multiples of 16 Equity Shares thereafter.	16 Equity Shares and in multiples of 16 Equity Shares thereafter.



Particulars	QIBs <sup>(1)</sup>	Non-Institutional Bidders	Retail Individual Bidders
Maximum Bid	Such number of Equity Shares not exceeding the size of the Offer, subject to applicable limits.	Such number of Equity Shares not exceeding the size of the Offer less the QIB Portion, subject to applicable limits.	Such number of Equity Shares whereby the Bid Amount does not exceed ₹ 200,000.
Mode of Allotment	Compulsorily in dematerialised form.		
Bid Lot	16 Equity Shares and in multiples of 16 Equity Shares thereafter		
Allotment Lot	A minimum of 16 Equity Shares and thereafter in multiples of one Equity Share		
Trading Lot	One Equity Share		
Who can Apply <sup>(3)</sup>	Mutual Funds, Venture Capital Funds, AIFs, FVCIs, FPIs, other than individuals, corporate bodies and family offices, public financial institution as defined in Section 2(72) of the Companies Act, 2013, a scheduled commercial bank, multilateral and bilateral development financial institution, state industrial development corporation, insurance company registered with the Insurance Regulatory and Development Authority, provident fund with minimum corpus of ₹ 250 million, pension fund with minimum corpus of ₹ 250 million, National Investment Fund set up by the Government of India, insurance funds set up and managed by army, navy or air force of the Union of India and insurance funds set up and managed by the Department of Posts, India and NBFC-SI.	Eligible NRIs, Resident Indian individuals, HUFs (in the name of the Karta), companies, corporate bodies, scientific institutions, societies and trusts, and FPIs who are individuals, corporate bodies and family offices.	Resident Indian individuals, HUFs (in the name of the Karta) and Eligible NRIs.
Terms of Payment <sup>(4)</sup>	<p><b>In case of Anchor Investors:</b> Full Bid Amount was payable by the Anchor Investors at the time of submission of their Bids.</p> <p><b>In case of all other Bidders:</b> Full Bid Amount was blocked in the bank account of the ASBA Bidder (other than Anchor Investors) that is specified in the ASBA Form at the time of submission of the ASBA Form or by the Sponsor Bank through the UPI Mechanism, that is specified in the ASBA Form at the time of submission of the ASBA Form.</p>		
Mode of Bidding	Only through the ASBA process (except for Anchor Investors).	Only through the ASBA process.	Only through the ASBA process.

<sup>(1)</sup> *Our Company and the Selling Shareholder (i.e. Rivendell PE LLC), in consultation with the BRLMs, allocated up to 60% of the QIB Portion to Anchor Investors on a discretionary basis in accordance with the SEBI ICDR Regulations. One-third of the Anchor Investor Portion was reserved for domestic Mutual Funds, subject to valid Bids being received from domestic Mutual Funds at or above the Anchor Investor Allocation Price. For further details, see "Offer Procedure" on page 280.*

<sup>(2)</sup> *Subject to valid Bids being received at or above the Offer Price. The Offer was made in terms of Rule 19(2)(b) of the SCRR and is being made through the Book Building Process in accordance with Regulation 6(1) of the SEBI ICDR Regulations. The Offer was made through the Book Building Process in accordance with Regulation 6(1) of the SEBI ICDR Regulations, wherein not more than 50% of the Offer was available for allocation on a proportionate basis to Qualified Institutional Buyers. Such number of Equity Shares representing 5% of the Net QIB Portion was available for allocation on a proportionate basis to Mutual Funds only. The remainder of the Net QIB Portion was available for allocation on a proportionate basis to QIBs (other than Anchor Investors), including Mutual Funds, subject to valid Bids being received from them at or above the Offer Price. However, if the aggregate demand from Mutual Funds was less than 5% of the Net QIB Portion, the balance Equity Shares available for allocation in the Mutual Fund Portion would have been added to the remaining Net QIB Portion for proportionate allocation to all QIBs. Further, not less than 15% of the Offer was available for allocation on a proportionate basis to Non-Institutional Bidders and not less than 35% of the Offer was available for allocation to Retail Individual Bidders in accordance with the SEBI ICDR Regulations, subject to valid Bids being received from them at or above the Offer Price. Subject to valid Bids being received at or above the Offer Price, under-subscription, if any, in the Non-Institutional Portion or the Retail Portion is allowed to be met with*

*spill-over from other categories or a combination of categories at the discretion of our Company, in consultation with the BRLMs and the Designated Stock Exchange, on a proportionate basis. However, under-subscription, if any, in the QIB Portion is not allowed to be met with spill-over from other categories or a combination of categories. In the event of under-subscription in the Offer, the Allotment for the valid Bids will be made, in the first instance, towards subscription for 90% of the Fresh Issue. If there remain any balance valid Bids in the Offer, the Allotment for the balance valid Bids will be made pro rata towards Equity Shares offered by the Selling Shareholders, and thereafter, towards the balance Fresh Issue. For further details, please see “Terms of the Offer” on page 272.*

- (3) In the event that a Bid is submitted in joint names, the relevant Bidders were required to ensure that the depository account is also held in the same joint names and the names are in the same sequence in which they appear in the Bid cum Application Form. The Bid cum Application Form was required to contain only the name of the First Bidder whose name should also have appeared as the first holder of the beneficiary account held in joint names. The signature of only such First Bidder would be required in the Bid cum Application Form and such First Bidder was deemed to have signed on behalf of the joint holders. Our Company reserves the right to reject, in its absolute discretion, all or any multiple Bids in any or all categories.*
- (4) Anchor Investors shall have paid the entire Bid Amount at the time of submission of the Anchor Investor Bid, provided that any positive difference between the Anchor Investor Allocation Price and the Offer Price, is payable by the Anchor Investor Pay-in Date as mentioned in the CAN.*
- (5) The Bids by FPIs with certain structures as described under “Offer Procedure - Bids by FPIs” on page 285 and having same PAN could be collated and identified as a single Bid in the Bidding process. The Equity Shares Allocated and Allotted to such successful Bidders (with same PAN) may be proportionately distributed. Bidders were required to confirm and were deemed to have represented to our Company, the Underwriters, their respective directors, officers, agents, affiliates and representatives that they are eligible under applicable law, rules, regulations, guidelines and approvals to acquire the Equity Shares.*

Bidders were required to confirm and were deemed to have represented to our Company, the Selling Shareholder (i.e. Rivendell PE LLC), the Underwriters, their respective directors, officers, agents, affiliates and representatives that they are eligible under applicable law, rules, regulations, guidelines and approvals to acquire the Equity Shares.

#### **Withdrawal of the Offer**

Our Company and the Selling Shareholder (i.e. Rivendell PE LLC), in consultation with the BRLMs, reserves the right not to proceed with the Fresh Issue and the Selling Shareholder, reserve the right not to proceed with the Offer for Sale, in whole or in part thereof, to the extent of the Offered Shares, after the Bid/ Offer Opening Date but before the Allotment. In such an event, our Company would issue a public notice in the newspapers in which the pre-Offer advertisements were published, within two days of the Bid/ Offer Closing Date or such other time as may be prescribed by SEBI, providing reasons for not proceeding with the Offer and inform the Stock Exchanges promptly on which the Equity Shares are proposed to be listed. The BRLMs, through the Registrar to the Offer, shall notify the SCSBs and the Sponsor Bank, to unblock the bank accounts of the ASBA Bidders within one Working Day from the date of receipt of such notification and also inform the Bankers to the Offer to process refunds to the Anchor Investors, as the case may be. The notice of withdrawal will be issued in the same newspapers where the pre-Offer advertisements have appeared and the Stock Exchanges will also be informed promptly.

If our Company and the Selling Shareholder (i.e. Rivendell PE LLC), in consultation with the BRLMs withdraws the Offer at any stage and thereafter determines that it will proceed with an issue of the Equity Shares, our Company shall file a fresh draft red herring prospectus with SEBI. Notwithstanding the foregoing, this Offer is also subject to obtaining (i) the final listing and trading approvals of the Stock Exchanges, which our Company shall apply for after Allotment; and (ii) the filing of the Prospectus with the RoC.

## OFFER PROCEDURE

All Bidders should read the General Information Document for Investing in Public Issues prepared and issued in accordance with the circular no. SEBI/HO/CFD/DIL1/CIR/P/2020/37 dated March 17, 2020 and the UPI Circulars (the “**General Information Document**”) which highlights the key rules, processes and procedures applicable to public issues in general in accordance with the provisions of the Companies Act, the SCRA, the SCRR and the SEBI ICDR Regulations. The General Information Document is available on the websites of the Stock Exchanges and the BRLMs. Please refer to the relevant provisions of the General Information Document which are applicable to the Offer especially in relation to the process for Bids by RIBs through the UPI Mechanism. The investors should note that the details and process provided in the General Information Document should be read along with this section.

Additionally, all Bidders may refer to the General Information Document for information in relation to (i) Category of investors eligible to participate in the Offer; (ii) maximum and minimum Bid size; (iii) price discovery and allocation; (iv) Payment Instructions for ASBA Bidders/Applicants; (v) Issuance of CAN and allotment in the Offer; (vi) General instructions (limited to instructions for completing the Bid Form); (vii) Submission of Bid cum Application Form; (viii) Other Instructions (limited to joint bids in cases of individual, multiple bids and instances when an application would be rejected on technical grounds); (ix) disposal of application (x) applicable provisions of the Companies Act, 2013 relating to punishment for fictitious applications; (xi) mode of making refunds; (xii) Designated Date and (xiii) interest in case of delay in allotment or refund.

SEBI vide its circular no. SEBI/HO/CFD/DIL2/CIR/P/2018/138 dated November 1, 2018 read with its circular no. SEBI/HO/CFD/DIL2/CIR/P/2019/50 dated April 3, 2019, has introduced an alternate payment mechanism using Unified Payments Interface (“**UPI**”) and consequent reduction in timelines for listing in a phased manner. From January 1, 2019, the UPI Mechanism for RIBs applying through Designated Intermediaries was made effective along with the existing process and existing timeline of T+6 days. (“**UPI Phase I**”). The UPI Phase I was effective till June 30, 2019.

With effect from July 1, 2019, SEBI vide its circular no. SEBI/HO/CFD/DIL2/CIR/P/2019/76 dated June 28, 2019, read with circular bearing number SEBI/HO/CFD/DIL2/CIR/P/2019/85 dated July 26, 2019 with respect to Bids by RIBs through Designated Intermediaries (other than SCSBs), the existing process of physical movement of forms from such Designated Intermediaries to SCSBs for blocking of funds has been discontinued and only the UPI Mechanism for such Bids with existing timeline of T+6 days was mandated for a period of three months or launch of five main board public issues, whichever is later (“**UPI Phase II**”). Subsequently, however, SEBI vide its circular no. SEBI/HO/CFD/DIL2/CIR/P/2020/50 dated March 30, 2020 extended the timeline for implementation of UPI Phase II till further notice. The final reduced timeline will be made effective using the UPI Mechanism for applications by RIBs (“**UPI Phase III**”), as may be prescribed by SEBI. The Offer will be undertaken pursuant to the processes and procedures under UPI Phase II, subject to any circulars, clarification or notification issued by the SEBI from time to time. Further, SEBI vide its circular no. SEBI/HO/CFD/DIL2/CIR/P/2021/2480/1/M dated March 16, 2021 has introduced certain additional measures for streamlining the process of initial public offers and redressing investor grievances. This circular has come into force for initial public offers on May 1, 2021 which has been subsequently revised by SEBI vide its circular no. SEBI/HO/CDF/DIL2/P/CIR/2021/570 dated June 2, 2021 in relation to certain aspects of completion of unblocking process and deferred implementation of certain measures for initial public offers opening on or after January 1, 2022. Provisions of these circular are deemed to form part of this Prospectus.

Our Company, the Selling Shareholder (i.e. Rivendell PE LLC) and the BRLMs do not accept any responsibility for the completeness and accuracy of the information stated in this section and are not liable for any amendment, modification or change in the applicable law which may occur after the date of this Prospectus. Bidders are advised to make their independent investigations and ensure that their Bids are submitted in accordance with applicable laws and do not exceed the investment limits or maximum number of the Equity Shares that can be held by them under applicable law or as specified in the Red Herring Prospectus and this Prospectus.

Further, our Company, Selling Shareholder (i.e. Rivendell PE LLC) and the members of the Syndicate are not liable for any adverse occurrences consequent to the implementation of the UPI Mechanism for application in this Offer.

## **Book Building Procedure**

The Offer is being made through the Book Building Process in accordance with Regulation 6(1) of the SEBI ICDR Regulations wherein not more than 50% of the Offer shall be allocated on a proportionate basis to QIBs, provided that our Company and the Selling Shareholder (i.e. Rivendell PE LLC), in consultation with the BRLMs, may allocate up to 60% of the QIB Portion to Anchor Investors on a discretionary basis in accordance with the SEBI ICDR Regulations, of which one-third shall be reserved for domestic Mutual Funds, subject to valid Bids being received from domestic Mutual Funds at or above the Anchor Investor Allocation Price. In the event of under-subscription, or non-allotment in the Anchor Investor Portion, the balance Equity Shares shall be added to the Net QIB Portion. Further, 5% of the Net QIB Portion shall be available for allocation on a proportionate basis only to Mutual Funds, and spill-over from the remainder of the Net QIB Portion shall be available for allocation on a proportionate basis to all QIBs (other than Anchor Investors), including Mutual Funds, subject to valid Bids being received at or above the Offer Price. Further, not less than 15% of the Offer shall be available for allocation on a proportionate basis to Non-Institutional Bidders and not less than 35% of the Offer shall be available for allocation to Retail Individual Bidders in accordance with the SEBI ICDR Regulations, subject to valid Bids being received at or above the Offer Price.

Under-subscription, if any, in any category, except in the QIB Portion, would be allowed to be met with spill over from any other category or combination of categories of Bidders at the discretion of our Company and the Selling Shareholder (i.e. Rivendell PE LLC), in consultation with the BRLMs and the Designated Stock Exchange subject to receipt of valid Bids received at or above the Offer Price. Under-subscription, if any, in the QIB Portion, would not be allowed to be met with spill-over from any other category or a combination of categories.

The Equity Shares, on Allotment, shall be traded only in the dematerialized mode on the platform of the Stock Exchanges.

Investors should note that the Equity Shares will be Allotted to all successful Bidders only in dematerialised form. The Bid cum Application Forms which do not have the details of the Bidders' depository account, including DP ID, Client ID, PAN and UPI ID, for RIBs using the UPI Mechanism, shall be treated as incomplete and will be rejected. Bidders will not have the option of being Allotted Equity Shares in physical form.

## **Phased implementation of Unified Payments Interface**

SEBI has issued the UPI Circulars in relation to streamlining the process of public issue of inter alia, equity shares. Pursuant to the UPI Circulars, the UPI Mechanism has been introduced in a phased manner as a payment mechanism (in addition to mechanism of blocking funds in the account maintained with SCSBs under ASBA) for applications by RIBs through Designated Intermediaries with the objective to reduce the time duration from public issue closure to listing from six Working Days to up to three Working Days. Considering the time required for making necessary changes to the systems and to ensure complete and smooth transition to the UPI payment mechanism, the UPI Circulars have introduced the UPI Mechanism in three phases in the following manner:

**Phase I:** This phase was applicable from January 1, 2019 until March 31, 2019 or floating of five main board public issues, whichever was later. Subsequently, the timeline for implementation of Phase I was extended till June 30, 2019. Under this phase, a RIB had the option to submit the ASBA Form with any of the Designated Intermediary and use his/ her UPI ID for the purpose of blocking of funds. The time duration from public issue closure to listing continued to be six Working Days.

**Phase II:** This phase has become applicable from July 1, 2019 and was to initially continue for a period of three months or floating of five main board public issues, whichever is later. SEBI vide its circular no. SEBI/HO/CFD/DCR2/CIR/P/2019/133 dated November 8, 2019 has decided to extend the timeline for implementation of UPI Phase II until March 31, 2020. Subsequently, SEBI vide its circular no. SEBI/HO/CFD/DIL2/CIR/P/2020/50 dated March 30, 2020 extended the timeline for implementation of UPI Phase II till further notice. Under this phase, submission of the ASBA Form by RIBs through Designated Intermediaries (other than SCSBs) to SCSBs for blocking of funds has been discontinued and replaced by the UPI Mechanism. However, the time duration from public issue closure to listing continues to be six Working Days during this phase.

**Phase III:** The commencement period of Phase III is yet to be notified. In this phase, the time duration from public issue closure to listing would be reduced to three Working Days.

For further details, refer to the General Information Document available on the websites of the Stock Exchanges and the BRLMs.

### **Bid cum Application Form**

Copies of the Bid cum Application Form (other than for Anchor Investors) and the abridged prospectus were available with the Designated Intermediaries at the Bidding Centres, and our Registered Office. An electronic copy of the Bid cum Application Form were also available for download on the websites of NSE ([www.nseindia.com](http://www.nseindia.com)) and BSE ([www.bseindia.com](http://www.bseindia.com)) at least one day prior to the Bid/Offer Opening Date.

Copies of the Anchor Investor Application Form will be available with the BRLMs.

All Bidders (other than Anchor Investors) were mandatorily required to participate in the Offer only through the ASBA process. Anchor Investors were not permitted to participate in the Offer through the ASBA process. The RIBs could additionally Bid through the UPI Mechanism.

RIBs using the UPI Mechanism were required to provide the valid UPI ID in the relevant space provided in the Bid cum Application Form and the Bid cum Application Form that does not contain the UPI ID are liable to be rejected. Retail Individual Investors bidding using the UPI Mechanism may also apply through the SCSBs and mobile applications using the UPI handles as provided on the website of the SEBI. ASBA Bidders using UPI Mechanism must provide bank account details and authorisation to block funds in their respective ASBA Accounts in the relevant space provided in the ASBA Form and the ASBA Forms that do not contain such details are liable to be rejected or the UPI ID, as applicable, in the relevant space provided in the ASBA Form.

ASBA Bidders were required to ensure that the Bids are made on ASBA Forms bearing the stamp of the Designated Intermediary, submitted at the Bidding Centres only (except in case of electronic ASBA Forms) and the ASBA Forms not bearing such specified stamp are liable to be rejected. RIBs using UPI Mechanism, may submit their ASBA Forms, including details of their UPI IDs, with the Syndicate, Sub-Syndicate members, Registered Brokers, RTAs or CDPs. RIBs authorising an SCSB to block the Bid Amount in the ASBA Account may submit their ASBA Forms with the SCSBs. ASBA Bidders must ensure that the ASBA Account has sufficient credit balance such that an amount equivalent to the full Bid Amount can be blocked by the SCSB or the Sponsor Bank, as applicable at the time of submitting the Bid. In order to ensure timely information to investors SCSBs are required to send SMS alerts to investors intimating them about the Bid Amounts blocked/unblocked.

Anchor Investors were not permitted to participate in the Offer through the ASBA process. For Anchor Investors, the Anchor Investor Application Form was available with the Book Running Lead Managers

The prescribed colour of the Bid cum Application Form for the various categories is as follows:

<b>Category</b>	<b>Colour of Bid cum Application Form*</b>
Resident Indians, including resident QIBs, Non-Institutional Bidders, Retail Individual Bidders and Eligible NRIs applying on a non-repatriation basis	White
Non-residents including Eligible NRIs, FVCIs, FPIs and registered bilateral and multilateral institutions applying on a repatriation basis	Blue
Anchor Investors	White

\* Excluding electronic Bid cum Application Forms

Notes:

(1) Electronic Bid cum Application forms and the abridged prospectus were also available for download on the website of NSE ([www.nseindia.com](http://www.nseindia.com)) and BSE ([www.bseindia.com](http://www.bseindia.com))

(2) Bid cum Application Forms for Anchor Investors were available at the offices of the BRLMs

In case of ASBA forms, the relevant Designated Intermediaries shall upload the relevant bid details in the electronic bidding system of the Stock Exchanges. For ASBA Forms (other than RIBs using UPI Mechanism) Designated Intermediaries (other than SCSBs) were required to submit/ deliver the ASBA Forms to the respective SCSB where the Bidder has an ASBA bank account and were required to not submit it to any non-SCSB bank or any Escrow Collection Bank. Stock Exchanges were required to validate the electronic bids with the records of the CDP for DP ID/Client ID and PAN, on a real time basis and bring inconsistencies to the notice of the relevant Designated Intermediaries, for rectification and re-submission within the time specified by Stock Exchanges.

Stock Exchanges allow modification of either DP ID/Client ID or PAN ID, bank code and location code in the Bid details already uploaded.

For Retail Individual Investors using the UPI Mechanism, the Stock Exchanges were required to share the Bid details (including UPI ID) with the Sponsor Bank on a continuous basis through API integration to enable the Sponsor Bank to initiate a UPI Mandate Request to such Retail Individual Investors for blocking of funds. The Sponsor Bank was required to initiate request for blocking of funds through NPCI to RIIs, who were required to accept the UPI Mandate Request for blocking of funds on their respective mobile applications associated with UPI ID linked bank account. The NPCI were required to maintain an audit trail for every Bid entered in the Stock Exchanges bidding platform, and the liability to compensate RIIs (Bidding through UPI Mechanism) in case of failed transactions is with the concerned entity (i.e. the Sponsor Bank, NPCI or the issuer bank) at whose end the lifecycle of the transaction has come to a halt. The NPCI were required to share the audit trail of all disputed transactions/ investor complaints to the Sponsor Bank and the issuer bank. The BRLMs were also required to obtain the audit trail from the Sponsor Banks and the Bankers to the Offer for analysing the same and fixing liability. For ensuring timely information to investors, SCSBs were required to send SMS alerts as specified in SEBI circular no. SEBI/HO/CFD/DIL2/CIR/P/2021/2480/1/M dated March 16, 2021, as amended pursuant to SEBI circular no. SEBI/HO/CFD/DIL2/P/CIR/2021/570 dated June 2, 2021

The Sponsor Bank will undertake a reconciliation of Bid responses received from Stock Exchanges and sent to NPCI and will also ensure that all the responses received from NPCI are sent to the Stock Exchanges platform with detailed error code and description, if any. Further, the Sponsor Bank will undertake reconciliation of all Bid requests and responses throughout their lifecycle on daily basis and share reports with the BRLMs in the format and within the timelines as specified under the UPI Circulars. Sponsor Bank and issuer banks shall download UPI settlement files and raw data files from the NPCI portal after every settlement cycle and do a three way reconciliation with Banks UPI switch data, CBS data and UPI raw data. NPCI is to coordinate with issuer banks and Sponsor Banks on a continuous basis.

#### **ELECTRONIC REGISTRATION OF BIDS**

a) The Designated Intermediary may register the Bids using the on-line facilities of the Stock Exchanges. The Designated Intermediaries can also set up facilities for off-line electronic registration of Bids, subject to the condition that they may subsequently upload the off-line data file into the on-line facilities for Book Building on a regular basis before the closure of the issue.

b) On the Bid/Issue Closing Date, the Designated Intermediaries may upload the Bids till such time as may be permitted by the Stock Exchanges and as disclosed in this Prospectus.

c) Only Bids that are uploaded on the Stock Exchanges Platform are considered for allocation/Allotment. The Designated Intermediaries are given till 1:00 pm on the next Working Day following the Bid/Issue Closing Date to modify select fields uploaded in the Stock Exchange Platform during the Bid/Issue Period after which the Stock Exchange(s) send the bid information to the Registrar to the Offer for further processing.

**The Equity Shares offered in the Offer have not been and will not be registered under the U.S. Securities Act or the securities laws of any state of the United States and may not be offered or sold in the United States except pursuant to an exemption from, or in a transaction not subject to, the registration requirements of the U.S. Securities Act and applicable state securities laws. The Equity Shares are being offered and sold only outside the United States in reliance on Regulation S and the applicable laws of the jurisdictions where such offers and sales occurs.**

**The Equity Shares have not been and will not be registered, listed or otherwise qualified in any other jurisdiction outside India and may not be offered or sold, and Bids may not be made by persons in any such jurisdiction, except in compliance with the applicable laws of such jurisdiction.**

#### **Participation by Promoters and members of the Promoter Group of the Company, the BRLMs and the Syndicate Members**

The BRLMs and the Syndicate Members were not allowed to purchase Equity Shares in this Offer in any manner, except towards fulfilling their underwriting obligations. However, the associates and affiliates of the BRLMs and the Syndicate Members could Bid for Equity Shares in the Offer, either in the QIB Portion or in the Non-Institutional Portion as applicable to such Bidders, where the allocation is on a proportionate basis and such

subscription may be on their own account or on behalf of their clients. All categories of investors, including associates or affiliates of the BRLMs and Syndicate Members, shall be treated equally for the purpose of allocation to be made on a proportionate basis.

Neither (i) the BRLMs or any associates of the BRLMs (except Mutual Funds sponsored by entities which are associates of the BRLMs or insurance companies promoted by entities which are associate of BRLMs or AIFs sponsored by the entities which are associate of the BRLMs or FPIs other than individuals, corporate bodies and family offices sponsored by the entities which are associates of the BRLMs) nor (ii) any “person related to the Promoters/ Promoter Group” could apply in the Offer under the Anchor Investor Portion.

For the purposes of this section, a QIB who has any of the following rights shall be deemed to be a “person related to the Promoters/ Promoter Group”: (a) rights under a shareholders’ agreement or voting agreement entered into with the Promoters or Promoter Group; (b) veto rights; or (c) right to appoint any nominee director on our Board. Further, an Anchor Investor shall be deemed to be an associate of the BRLMs, if: (a) either of them controls, directly or indirectly through its subsidiary or holding company, not less than 15% of the voting rights in the other; or (b) either of them, directly or indirectly, by itself or in combination with other persons, exercises control over the other; or (c) there is a common director, excluding a nominee director, amongst the Anchor Investor and the BRLMs.

The Promoters and members of the Promoter Group will not participate in the Offer.

### **Bids by Mutual Funds**

With respect to Bids by Mutual Funds, a certified copy of their SEBI registration certificate was required to be lodged along with the Bid cum Application Form. Failing this, our Company and Selling Shareholder (i.e. Rivendell PE LLC) in consultation with the BRLMs reserved the right to reject any Bid without assigning any reason thereof.

Bids made by asset management companies or custodians of Mutual Funds were required to specifically state names of the concerned schemes for which such Bids were made.

In case of a Mutual Fund, a separate Bid could be made in respect of each scheme of the Mutual Fund registered with SEBI and such Bids in respect of more than one scheme of the Mutual Fund would not be treated as multiple Bids provided that the Bids clearly indicated the scheme concerned for which the Bid has been made.

No Mutual Fund scheme shall invest more than 10% of its NAV in equity shares or equity related instruments of any single company provided that the limit of 10% shall not be applicable for investments in case of index funds or sector or industry specific schemes. No Mutual Fund under all its schemes should own more than 10% of any company’s paid-up share capital carrying voting rights.

### **Bids by Eligible NRIs**

Eligible NRIs could obtain copies of Bid cum Application Form from the Designated Intermediaries. Only Bids accompanied by payment in Indian Rupees or freely convertible foreign exchange will be considered for Allotment. Eligible NRI Bidders bidding on a repatriation basis by using the Non-Resident Forms could authorize their respective SCSB to block their Non-Resident External (“NRE”) accounts, or Foreign Currency Non-Resident (“FCNR”) Accounts, and eligible NRI Bidders bidding on a non-repatriation basis by using Resident Forms could authorize their respective SCSB to block their Non-Resident Ordinary (“NRO”) accounts for the full Bid Amount, at the time of the submission of the Bid cum Application Form.

Eligible NRIs Bidding on non-repatriation basis were advised to use the Bid cum Application Form for residents (White in colour). Eligible NRIs Bidding on a repatriation basis were advised to use the Bid cum Application Form meant for Non-Residents (Blue in colour).

For details of investment by NRIs, see “*Restrictions on Foreign Ownership of Indian Securities*” on page 298. Participation of Eligible NRIs was subject to the FEMA Non-debt Instruments Rules.

## **Bids by HUFs**

Hindu Undivided Families or HUFs, were required to be made in the individual name of the Karta. The Bidder/Applicant was required to specify that the Bid was being made in the name of the HUF in the Bid cum Application Form/Application Form as follows: "Name of sole or first Bidder/Applicant: XYZ Hindu Undivided Family applying through XYZ, where XYZ is the name of the Karta". Bids/Applications by HUFs were considered at par with Bids/Applications from individuals.

## **Bids by FPIs**

In terms of the SEBI FPI Regulations, the issue of Equity Shares to a single FPI or an investor group (which means the same multiple entities having common ownership directly or indirectly of more than 50% or common control) must be below 10% of our post-Offer Equity Share capital. Further, in terms of the FEMA Non-debt Instruments Rules, the total holding by each FPI, of an investor group, shall be below 10% of the total paid-up Equity Share capital of our Company on a fully diluted basis and the aggregate limit for FPI investments shall be the sectoral caps applicable to our Company, which is 100% of the total paid-up Equity Share capital of our Company on a fully diluted basis. In case the total holding of an FPI or investor group increases beyond 10% of the total paid-up Equity Share capital of our Company, on a fully diluted basis, the total investment made by the FPI or investor group will be re-classified as FDI subject to the conditions as specified by SEBI and the RBI in this regard and our Company and the investor will be required to comply with applicable reporting requirements. Further, the total holdings of all FPIs put together, with effect from April 1, 2020, can be up to the sectoral cap applicable to the sector in which our Company operates (i.e., up to 100%). In terms of the FEMA Rules, for calculating the aggregate holding of FPIs in a company, holding of all registered FPIs shall be included. Bids by FPIs which utilise the multi investment manager structure, submitted with the same PAN but with different beneficiary account numbers, Client IDs and DP IDs may not be treated as multiple Bids.

FPIs are permitted to participate in the Offer subject to compliance with conditions and restrictions which may be specified by the Government from time to time. In terms of the FEMA Non-debt Instruments Rules, for calculating the aggregate holding of FPIs in a company, holding of all registered FPIs shall be included.

Subject to compliance with all applicable Indian laws, rules, regulations, guidelines and approvals in terms of Regulation 22 of the SEBI FPI Regulations, an FPI, may issue, subscribe to or otherwise deal in offshore derivative instruments (as defined under the SEBI FPI Regulations as any instrument, by whatever name called, which is issued overseas by a FPI against securities held by it in India, as its underlying) directly or indirectly, only in the event (i) such offshore derivative instruments are issued only by persons registered as Category I FPIs; (ii) such offshore derivative instruments are issued only to persons eligible for registration as Category I FPIs; (iii) such offshore derivative instruments are issued after compliance with 'know your client' norms; and (iv) such other conditions as may be specified by SEBI from time to time.

An FPI issuing offshore derivative instruments was also required to ensure that any transfer of offshore derivative instruments issued by, or on behalf of it subject to, inter alia, the following conditions:

- (a) such offshore derivative instruments were transferred to persons subject to fulfilment of SEBI FPI Regulations; and
- (b) prior consent of the FPI was obtained for such transfer, except when the persons to whom the offshore derivative instruments were to be transferred were pre-approved by the FPI.

The FPIs who wished to participate in the Offer were advised to use the Bid cum Application Form for non-residents.

Bids received from FPIs bearing the same PAN shall be treated as multiple Bids and are liable to be rejected, except for Bids from FPIs that utilize the multiple investment manager structure in accordance with the operational guidelines for FPIs and designated Depository Participants issued to facilitate implementation of SEBI FPI Regulations (such structure referred to as "**MIM Structure**"), provided such Bids have been made with different beneficiary account numbers, Client IDs and DP IDs.

Accordingly, it should be noted that multiple Bids received from FPIs, who do not utilize the MIM Structure, and bear the same PAN, are liable to be rejected. In order to ensure valid Bids, FPIs making multiple Bids using the same PAN, and with different beneficiary account numbers, Client IDs and DP IDs, are required to provide a



confirmation in the Bid cum Application Forms that the relevant FPIs making multiple Bids utilize the MIM Structure. In the absence of such confirmation from the relevant FPIs, such multiple Bids shall be rejected.

#### **Bids by SEBI registered VCFs, AIFs and FVCIs**

The Securities and Exchange Board of India (Venture Capital Funds) Regulations, 1996 (“**SEBI VCF Regulations**”) as amended, inter alia prescribe the investment restrictions on VCFs, registered with SEBI. The Securities and Exchange Board of India (Alternative Investment Funds) Regulations, 2012 (“**SEBI AIF Regulations**”) prescribe, amongst others, the investment restrictions on AIFs. The Securities and Exchange Board of India (Foreign Venture Capital Investors) Regulations, 2000 as amended (“**SEBI FVCI Regulations**”) prescribe the investment restrictions on FVCIs.

Accordingly, the holding in any company by any individual VCF or FVCIs registered with SEBI should not exceed 25% of the corpus of the VCF or FVCI. Further, VCFs and FVCIs can invest only up to 33.33% of the investible funds in various prescribed instruments, including in public offering.

Category I and II AIFs cannot invest more than 25% of the investible funds in one investee company. A Category III AIF cannot invest more than 10% of the investible funds in one investee company. A VCF registered as a Category I AIF, as defined in the SEBI AIF Regulations, cannot invest more than one-third of its investible funds by way of subscription to an initial public offering of a venture capital undertaking whose shares are proposed to be listed. Additionally, the VCFs which have not re-registered as an AIF under the SEBI AIF Regulations shall continue to be regulated by the SEBI VCF Regulations until the existing fund or scheme managed by the fund is wound up and such funds shall not launch any new scheme after the notification of the SEBI AIF Regulations.

**All non-resident investors should note that refunds (in case of Anchor Investors), dividends and other distributions, if any, will be payable in Indian Rupees only and net of bank charges and commission.**

Our Company, Selling Shareholder (i.e. Rivendell PE LLC) or the BRLMs will not be responsible for loss, if any, incurred by the Bidder on account of conversion of foreign currency.

#### **Bids by limited liability partnerships**

In case of Bids made by limited liability partnerships registered under the Limited Liability Partnership Act, 2008, a certified copy of certificate of registration issued under the Limited Liability Partnership Act, 2008, should have been attached to the Bid cum Application Form. Failing this, our Company and the Selling Shareholder (i.e. Rivendell PE LLC) in consultation with the BRLMs reserves the right to reject any Bid without assigning any reason thereof.

#### **Bids by banking companies**

In case of Bids made by banking companies registered with RBI, certified copies of: (i) the certificate of registration issued by RBI, and (ii) the approval of such banking company’s investment committee were required to be attached to the Bid cum Application Form, failing which our Company and Selling Shareholder (i.e. Rivendell PE LLC) in consultation with the BRLMs reserve the right to reject any Bid without assigning any reason.

#### **Bids by SCSBs**

SCSBs participating in the Offer were required to comply with the terms of the SEBI circulars (Nos. CIR/CFD/DIL/12/2012 and CIR/CFD/DIL/1/2013) dated September 13, 2012 and January 2, 2013. Such SCSBs were required to ensure that for making applications on their own account using ASBA, they should have had a separate account in their own name with any other SEBI registered SCSBs. Further, such account should have been used solely for the purpose of making application in public issues and clear demarcated funds should be available in such account for such applications.

#### **Bids by insurance companies**

In case of Bids made by insurance companies registered with the IRDAI, a certified copy of certificate of registration issued by IRDAI was required to be attached to the Bid cum Application Form. Failing this, our

Company and Selling Shareholder (i.e. Rivendell PE LLC) in consultation with the BRLMs reserve the right to reject any Bid without assigning any reason thereof.

The exposure norms for insurers are prescribed under the Insurance Regulatory and Development Authority (Investment) Regulations, 2016, as amended (“**IRDAI Investment Regulations**”), based on investments in the equity shares of a company, the entire group of the investee company and the industry sector in which the investee company operates. Bidders were advised to refer to the IRDAI Investment Regulations for specific investment limits applicable to them.

#### **Bids by provident funds/pension funds**

In case of Bids made by provident funds/pension funds, subject to applicable laws, with minimum corpus of ₹250 million, a certified copy of a certificate from a chartered accountant certifying the corpus of the provident fund/pension fund must be attached to the Bid cum Application Form. Failing this, our Company and Selling Shareholder (i.e. Rivendell PE LLC) in consultation with the BRLMs reserves the right to reject any Bid, without assigning any reason thereof.

#### **Bids under Power of Attorney**

In case of Bids made pursuant to a power of attorney or by limited companies, corporate bodies, registered societies, Eligible FPIs, Mutual Funds, insurance companies, insurance funds set up by the army, navy or air force of the India, insurance funds set up by the Department of Posts, India or the National Investment Fund and provident funds with a minimum corpus of ₹250 million (subject to applicable law) and pension funds with a minimum corpus of ₹250 million, a certified copy of the power of attorney or the relevant resolution or authority, as the case may be, along with a certified copy of the memorandum of association and articles of association and/or bye laws were required to be lodged along with the Bid cum Application Form. Failing this, our Company and Selling Shareholder (i.e. Rivendell PE LLC) in consultation with the BRLMs reserve the right to accept or reject any Bid in whole or in part, in either case, without assigning any reason thereof.

Our Company and the Selling Shareholder (i.e. Rivendell PE LLC) in consultation with the BRLMs in their absolute discretion, reserve the right to relax the above condition of simultaneous lodging of the power of attorney along with the Bid cum Application Form subject to the terms and conditions that our Company and the Selling Shareholder (i.e. Rivendell PE LLC) in consultation with the BRLMs may deem fit.

#### **Bids by Anchor Investors**

- (a.) In accordance with the SEBI ICDR Regulations, in addition to details and conditions mentioned in this section the key terms for participation by Anchor Investors are provided below. Anchor Investor Application Forms were made available for the Anchor Investor Portion at the offices of the BRLMs.
- (b.) The Bid should have been for a minimum of such number of Equity Shares so that the Bid Amount exceeds ₹ 100.00 million. A Bid cannot be submitted for over 60% of the QIB Portion. In case of a Mutual Fund, separate bids by individual schemes of a Mutual Fund were aggregated to determine the minimum application size of ₹ 100.00 million.
- (c.) One-third of the Anchor Investor Portion was reserved for allocation to domestic Mutual Funds.
- (d.) Bidding for Anchor Investors opened one Working Day before the Bid/Offer Opening Date, and was completed on the same day.
- (e.) Our Company and the Selling Shareholders, in consultation with the BRLMs finalised allocation to the Anchor Investors on a discretionary basis, provided that the minimum number of Allottees in the Anchor Investor Portion were not less than: maximum of two Anchor Investors, where allocation under the Anchor Investor Portion is up to ₹ 100.00 million; minimum of two and maximum of 15 Anchor Investors, where the allocation under the Anchor Investor Portion is more than ₹ 100.00 million but up to ₹ 2,500.00 million, subject to a minimum Allotment of ₹ 50.00 million per Anchor Investor; and in case of allocation above ₹ 2,500.00 million under the Anchor Investor Portion, a minimum of five such investors and a maximum of 15 Anchor Investors for allocation up to ₹ 2,500.00 million, and an additional 10 Anchor Investors for every additional ₹ 2,500.00 million, subject to minimum Allotment of ₹ 50.00 million per Anchor Investor.

- (f.) Allocation to Anchor Investors was completed on the Anchor Investor Bid/Offer Period. The number of Equity Shares allocated to Anchor Investors and the price at which the allocation was made, has been made available in the public domain by the BRLMs before the Bid/Offer Opening Date, through intimation to the Stock Exchanges.
- (g.) Anchor Investors could not withdraw or lower the size of their Bids at any stage after submission of the Bid.
- (h.) If the Offer Price has been greater than the Anchor Investor Allocation Price, the additional amount being the difference between the Offer Price and the Anchor Investor Offer Price would have been payable by the Anchor Investors on the Anchor Investor Pay-In Date specified in the CAN. If the Offer Price is lower than the Anchor Investor Offer Price, Allotment to successful Anchor Investors will be at the higher price.
- (i.) Equity Shares Allotted in the Anchor Investor Portion will be locked in for a period of 30 days from the date of Allotment.
- (j.) Neither the BRLMs nor any associate of the BRLMs (except Mutual Funds sponsored by entities which are associates of the BRLMs or insurance companies promoted by entities which are associate of BRLMs or AIFs sponsored by the entities which are associate of the BRLMs or FPIs, other than individuals, corporate bodies and family offices sponsored by the entities which are associate of the and BRLMs) , nor any "person related to Promoters or Promoter Group" could apply in the Offer under the Anchor Investor Portion.
- (k.) Bids made by QIBs under both the Anchor Investor Portion and the QIB Portion were not considered multiple Bids. The above information is given for the benefit of the Bidders. Our Company, the Selling Shareholders and the BRLMs are not liable for any amendments or modification or changes in applicable laws or regulations, which may occur after the date of this Prospectus. Bidders are advised to make their independent investigations and ensure that any single Bid from them does not exceed the applicable investment limits or maximum number of the Equity Shares that can be held by them under applicable law or regulation or as specified in this Prospectus.

#### **Bids by Systemically Important Non-Banking Financial Companies**

In case of Bids made by Systemically Important NBFCs registered with RBI, certified copies of: (i) the certificate of registration issued by RBI, (ii) certified copy of its last audited financial statements on a standalone basis and a net worth certificate from its statutory auditors, and (iii) such other approval as may be required by the Systemically Important NBFCs, are required to be attached to the Bid cum Application Form. Failing this, our Company in consultation with the BRLMs, reserves the right to reject any Bid without assigning any reason thereof. Systemically Important NBFCs participating in the Offer shall comply with all applicable regulations, guidelines and circulars issued by RBI from time to time.

The investment limit for Systemically Important NBFCs shall be as prescribed by RBI from time to time.

**In accordance with existing regulations issued by the RBI, OCBs cannot participate in this Offer.**

**The above information is given for the benefit of the Bidders. Our Company, the Selling Shareholder (i.e. Rivendell PE LLC) and the BRLMs are not liable for any amendments or modification or changes in applicable laws or regulations, which may occur after the date of this Prospectus. Bidders are advised to make their independent investigations and ensure that any single Bid from them does not exceed the applicable investment limits or maximum number of the Equity Shares that can be held by them under applicable law or regulation or as specified in the Red Herring Prospectus and this Prospectus.**

#### **Information for Bidders**

The relevant Designated Intermediary will enter each Bid option into the electronic Bidding system as a separate Bid and generate an acknowledgement slip ("**Acknowledgement Slip**"), for each price and demand option and give the same to the Bidder. Therefore, a Bidder could have received up to three Acknowledgement Slips for each Bid cum Application Form. It was the Bidder's responsibility to obtain the Acknowledgment Slip from the relevant Designated Intermediary. The registration of the Bid by the Designated Intermediary does not guarantee

that the Equity Shares shall be allocated/Allotted. Such Acknowledgement Slip will be non-negotiable and by itself will not create any obligation of any kind. When a Bidder revised his or her Bid, he/she was required to surrender the earlier Acknowledgement Slip and could request for a revised Acknowledgment Slip from the relevant Designated Intermediary as proof of his or her having revised the previous Bid.

In relation to electronic registration of Bids, the permission given by the Stock Exchanges to use their network and software of the electronic bidding system should not in any way be deemed or construed to mean that the compliance with various statutory and other requirements by our Company and/or the BRLMs are cleared or approved by the Stock Exchanges; nor does it in any manner warrant, certify or endorse the correctness or completeness of compliance with the statutory and other requirements, nor does it take any responsibility for the financial or other soundness of our Company, the management or any scheme or project of our Company; nor does it in any manner warrant, certify or endorse the correctness or completeness of any of the contents of the Red Herring Prospectus or this Prospectus; nor does it warrant that the Equity Shares will be listed or will continue to be listed on the Stock Exchanges.

In the event of a downward revision in the Price Band, Retail Individual Bidders who have bid at Cut-off Price may revise their Bid; otherwise, the excess amount paid at the time of Bidding would be unblocked after Allotment is finalised.

Any revision of the Bid shall be accompanied by instructions to block the incremental amount, if any, to be paid on account of the upward revision of the Bid.

### **General Instructions**

#### ***Do's:***

1. Check if you are eligible to apply as per the terms of the Red Herring Prospectus and under applicable law, rules, regulations, guidelines and approvals. All Bidders (other than Anchor Investors) should submit their Bids through the ASBA process only;
2. Ensure that you have Bid within the Price Band;
3. Read all the instructions carefully and complete the Bid cum Application Form, as the case may be, in the prescribed form;
4. Ensure that you have mentioned the correct ASBA Account number if you are not an RIB using the UPI Mechanism in the Bid cum Application Form and if you are an RIB using the UPI Mechanism ensure that you have mentioned the correct UPI ID (with maximum length of 45 characters including the handle), in the Bid cum Application Form;
5. RIBs using UPI Mechanism through the SCSBs and mobile applications shall ensure that the name of the bank appears in the list of SCSBs which are live on UPI, as displayed on the SEBI website. RIBs shall ensure that the name of the app and the UPI handle which is used for making the application appears in Annexure 'A' to the SEBI circular no. SEBI/HO/CFD/DIL2/COR/P/2019/85 dated July 26, 2019;
6. Ensure that your Bid cum Application Form bearing the stamp of a Designated Intermediary is submitted to the Designated Intermediary at the Bidding Centre within the prescribed time;
7. Ensure that you have funds equal to the Bid Amount in the ASBA Account maintained with the SCSB, before submitting the ASBA Form to any of the Designated Intermediaries;
8. If the first applicant is not the bank account holder, ensure that the Bid cum Application Form is signed by the account holder. Ensure that you have mentioned the correct bank account number in the Bid cum Application Form;
9. Ensure that the signature of the First Bidder in case of joint Bids, is included in the Bid cum Application Forms;

10. Ensure that you request for and receive a stamped acknowledgement counterfoil of the Bid cum Application Form for all your Bid options from the concerned Designated Intermediary;
11. Ensure that the name(s) given in the Bid cum Application Form is/are exactly the same as the name(s) in which the beneficiary account is held with the Depository Participant. In case of joint Bids, the Bid cum Application Form should contain only the name of the First Bidder whose name should also appear as the first holder of the beneficiary account held in joint names. Ensure that the signature of the First Bidder is included in the Bid cum Application Forms;
12. RIBs Bidding in the Offer to ensure that they shall use only their own ASBA Account or only their own bank account linked UPI ID (only for RIBs using the UPI Mechanism) to make an application in the Offer and not ASBA Account or bank account linked UPI ID of any third party;
13. Ensure that you submit the revised Bids to the same Designated Intermediary, through whom the original Bid was placed and obtain a revised acknowledgment;
14. Ensure that you have correctly signed the authorisation/undertaking box in the Bid cum Application Form, or have otherwise provided an authorisation to the SCSB or Sponsor Bank, as applicable, via the electronic mode, for blocking funds in the ASBA Account equivalent to the Bid Amount mentioned in the Bid cum Application Form, as the case may be, at the time of submission of the Bid. In case of RIBs submitting their Bids and participating in the Offer through the UPI Mechanism, ensure that you authorise the UPI Mandate Request raised by the Sponsor Bank for blocking of funds equivalent to Bid Amount and subsequent debit of funds in case of Allotment;
15. Except for Bids (i) on behalf of the Central or State Governments and the officials appointed by the courts, who, in terms of the SEBI circular no. MRD/DoP/Cir-20/2008 dated June 30, 2008, may be exempt from specifying their PAN for transacting in the securities market, (ii) submitted by investors who are exempt from the requirement of obtaining/specifying their PAN for transacting in the securities market, and (iii) Bids by persons resident in the state of Sikkim, who, in terms of a SEBI circular dated July 20, 2006, may be exempted from specifying their PAN for transacting in the securities market, all Bidders should mention their PAN allotted under the IT Act. The exemption for the Central or the State Government and officials appointed by the courts and for investors residing in the State of Sikkim is subject to (a) the Demographic Details received from the respective depositories confirming the exemption granted to the beneficiary owner by a suitable description in the PAN field and the beneficiary account remaining in "active status"; and (b) in the case of residents of Sikkim, the address as per the Demographic Details evidencing the same. All other applications in which PAN is not mentioned will be rejected;
16. Ensure that the Demographic Details are updated, true and correct in all respects;
17. Ensure that thumb impressions and signatures other than in the languages specified in the Eighth Schedule to the Constitution of India are attested by a Magistrate or a Notary Public or a Special Executive Magistrate under official seal;
18. Ensure that the category and the investor status is indicated in the Bid cum Application Form;
19. Ensure that in case of Bids under power of attorney or by limited companies, corporates, trust, etc., relevant documents are submitted;
20. Ensure that Bids submitted by any person resident outside India is in compliance with applicable foreign and Indian laws;
21. Since the Allotment will be in demat form only, ensure that the Bidder's depository account is active, the correct DP ID, Client ID, the PAN, UPI ID, if applicable, are mentioned in their Bid cum Application Form and that the name of the Bidder, the DP ID, Client ID, the PAN and UPI ID, if applicable, entered into the online IPO system of the Stock Exchanges by the relevant Designated Intermediary, as applicable, matches with the name, DP ID, Client ID, PAN and UPI ID, if applicable, available in the Depository database;
22. RIBs who wish to revise their Bids using the UPI Mechanism, should submit the revised Bid with the Designated Intermediaries, pursuant to which RIBs should ensure acceptance of the UPI Mandate

- Request received from the Sponsor Bank to authorise blocking of funds equivalent to the revised Bid Amount in the RIB's ASBA Account;
23. Anchor Investors should submit the Anchor Investor Application Forms to the BRLMs;
  24. Ensure that you have accepted the UPI Mandate Request received from the Sponsor Bank prior to 12:00 p.m. of the Working Day immediately after the Bid/ Offer Closing Date;
  25. FPIs making MIM Bids using the same PAN, and different beneficiary account numbers, Client IDs and DP IDs, are required to submit a confirmation that their Bids are under the MIM structure and indicate the name of their investment managers in such confirmation which shall be submitted along with each of their Bid cum Application Forms. In the absence of such confirmation from the relevant FPIs, such MIM Bids shall be rejected;
  26. RIBs shall ensure that details of the Bid are reviewed and verified by opening the attachment in the UPI Mandate Request and then proceed to authorize the UPI Mandate Request using his/her UPI PIN. Upon the authorization of the mandate using his/her UPI PIN, an RIB may be deemed to have verified the attachment containing the application details of the RIB in the UPI Mandate Request and have agreed to block the entire Bid Amount and authorized the Sponsor Bank to block the Bid Amount mentioned in the Bid Cum Application Form; and
  27. Ensure that while Bidding through a Designated Intermediary, the Bid cum Application Form (other than for Anchor Investors and RIBs bidding using the UPI Mechanism) is submitted to a Designated Intermediary in a Bidding Centre and that the SCSB where the ASBA Account, as specified in the ASBA Form, is maintained has named at least one branch at that location for the Designated Intermediary to deposit ASBA Forms (a list of such branches is available on the website of SEBI at [www.sebi.gov.in](http://www.sebi.gov.in)).

The Bid cum Application Form was liable to be rejected if the above instructions, or any other condition as specified in the Red Herring Prospectus, as applicable, were not complied with. Application made using incorrect UPI handle or using a bank account of an SCSB or SCSBs which is not mentioned in the Annexure 'A' to the SEBI circular no. SEBI/HO/CFD/DIL2/CIR/P/2019/85 dated July 26, 2019 was liable to be rejected.

***Don'ts:***

1. Do not Bid for lower than the minimum Bid size;
2. Do not Bid for a Bid Amount exceeding ₹200,000 for Bids by Retail Individual Bidders;
3. Do not pay the Bid Amount in cheques, demand drafts or by cash, money order, postal order or by stock invest;
4. Do not send Bid cum Application Forms by post; instead submit the same to the Designated Intermediary only;
5. Do not Bid at Cut-off Price for Bids by QIBs and Non-Institutional Bidders;
6. Do not instruct your respective banks to release the funds blocked in the ASBA Account under the ASBA process;
7. Do not submit the Bid for an amount more than funds available in your ASBA account.
8. Do not submit Bids on plain paper or on incomplete or illegible Bid cum Application Forms or on Bid cum Application Forms in a colour prescribed for another category of a Bidder;
9. In case of ASBA Bidders, do not submit more than one ASBA Forms per ASBA Account;
10. If you are a RIB and are using UPI mechanism, do not submit more than one ASBA Form for each UPI ID;
11. Anchor Investors should not Bid through the ASBA process;

12. Do not submit the ASBA Forms to any Designated Intermediary that is not authorised to collect the relevant ASBA Forms or to our Company;
13. Do not Bid on a Bid cum Application Form that does not have the stamp of the relevant Designated Intermediary;
14. Do not submit the General Index Register (GIR) number instead of the PAN;
15. Do not submit incorrect details of the DP ID, Client ID, PAN and UPI ID, if applicable, or provide details for a beneficiary account which is suspended or for which details cannot be verified by the Registrar to the Offer;
16. Do not submit a Bid in case you are not eligible to acquire Equity Shares under applicable law or your relevant constitutional documents or otherwise;
17. Do not Bid if you are not competent to contract under the Indian Contract Act, 1872 (other than minors having valid depository accounts as per Demographic Details provided by the depository);
18. Do not submit a Bid/revise a Bid Amount, with a price less than the Floor Price or higher than the Cap Price;
19. Do not submit a Bid using UPI ID, if you are not a RIB;
20. Do not Bid on another ASBA Form or the Anchor Investor Application Form, as the case may be, after you have submitted a Bid to any of the Designated Intermediaries;
21. Do not Bid for Equity Shares in excess of what is specified for each category;
22. Do not fill up the Bid cum Application Form such that the Equity Shares Bid for, exceeds the Offer size and/or investment limit or maximum number of the Equity Shares that can be held under applicable laws or regulations or maximum amount permissible under applicable laws or regulations, or under the terms of the Red Herring Prospectus;
23. Do not withdraw your Bid or lower the size of your Bid (in terms of quantity of the Equity Shares or the Bid Amount) at any stage, if you are a QIB or a Non-Institutional Bidder. Retail Individual Bidders can revise or withdraw their Bids on or before the Bid/Offer Closing Date;
24. Do not submit Bids to a Designated Intermediary at a location other than the Bidding Centres;
25. If you are an RIB which is submitting the ASBA Form with any of the Designated Intermediaries and using your UPI ID for the purpose of blocking of funds, do not use any third party bank account or third party linked bank account UPI ID; and
26. Do not Bid if you are an OCB.

The Bid cum Application Form was liable to be rejected if the above instructions, as applicable, are not complied with.

Further, in case of any pre-Offer or post Offer related issues regarding share certificates/demat credit/refund orders/unblocking etc., investors shall reach out to the Company Secretary and Compliance Officer. For details of our Company Secretary and Compliance Officer, see "General Information" on page 56.

In case of (i) any delay in unblocking of amounts in the ASBA Accounts (including amounts blocked through the UPI Mechanism) for cancelled/ withdrawn/ deleted ASBA Forms, the Bidder shall be compensated at a uniform rate of ₹100 per day or 15% per annum of the Bid Amount, whichever is higher from the date on which the amounts are unblocked; (ii) any blocking of multiple amounts for the same ASBA Form (for amounts blocked through the UPI Mechanism), the Bidder shall be compensated at a uniform rate ₹100 per day or 15% per annum of the total cumulative blocked amount except the original application amount, whichever is higher from the date on which such multiple amounts were blocked till the date of actual unblock; (iii) any blocking of amounts more than the Bid Amount, the Bidder shall be compensated at a uniform rate of ₹100 per day or 15% per annum of the

difference in amount, whichever is higher from the date on which such excess amounts were blocked till the date of actual unblock; (iv) any delay in unblocking of non-allotted/ partially allotted Bids, exceeding four Working Days from the Bid/Offer Closing Date, the Bidder shall be compensated at a uniform rate of ₹100 per day or 15% per annum of the Bid Amount, whichever is higher for the entire duration of delay exceeding four Working Days from the Bid/ Offer Closing Date by the SCSB responsible for causing such delay in unblocking. The post Offer BRLMs shall be liable for compensating the Bidder at a uniform rate of ₹100 per day or 15% per annum of the Bid Amount, whichever is higher from the date of receipt of the Investor grievance until the date on which the blocked amounts are unblocked.

Further, the helpline details of the BRLMs pursuant to the SEBI circular no. SEBI/HO/CFD/DIL-2/OW/P/2021/2481/1/M dated March 16, 2021, are set forth in the table below:

<u>S. No.</u>	<u>Name of BRLMs</u>	<u>Helpline (email)</u>	<u>Telephone</u>
1	Equirus Capital Private Limited	<a href="mailto:rolexrings.ipo@equirus.com">rolexrings.ipo@equirus.com</a>	+91 22 4332 0700
2	IDBI Capital Markets & Securities Limited	<a href="mailto:rolex.ipo@idbicapital.com">rolex.ipo@idbicapital.com</a>	+91 22 2217 1700
3	JM Financial Limited	<a href="mailto:rolexrings@jmfl.com">rolexrings@jmfl.com</a>	+91 22 6630 3030

### **Grounds for Technical Rejections**

In addition to the grounds for rejection of Bids on technical grounds as provided in the General Information Document, Bidders were requested to note that Bids may be rejected on the following additional technical grounds:

1. Bid submitted without instruction to the SCSB to block the entire Bid Amount;
2. Bids which do not contain details of the Bid Amount and the bank account or UPI ID (for RIBs using the UPI Mechanism) details in the ASBA Form;
3. Bids submitted on a plain paper;
4. Bids submitted by RIBs using the UPI Mechanism through an SCSB and/or using a Mobile App or UPI handle, not listed on the website of SEBI;
5. Bids under the UPI Mechanism submitted by RIBs using third party bank accounts or using a third party linked bank account UPI ID, subject to availability of information from the Sponsor Bank;
6. ASBA Form submitted to a Designated Intermediary does not bear the stamp of the Designated Intermediary;
7. Bids submitted without the signature of the First Bidder or sole Bidder;
8. The ASBA Form not being signed by the account holders, if the account holder is different from the Bidder;
9. Bids by persons for whom PAN details have not been verified and whose beneficiary accounts are “suspended for credit” in terms of SEBI circular (reference number: CIR/MRD/DP/ 22 /2010) dated July 29, 2010;
10. Bids by Retail Individual Bidders with Bid Amount for a value of more than ₹ 200,000;
11. GIR number furnished instead of PAN;
12. Bids by persons who are not eligible to acquire Equity Shares in terms of all applicable laws, rules, regulations, guidelines and approvals; and
13. Bids accompanied by cheque(s), demand draft(s), stock invest, money order, postal order or cash.



### **Names of entities responsible for finalising the basis of allotment in a fair and proper manner**

The authorised employees of the Designated Stock Exchange, along with the BRLMs and the Registrar, shall ensure that the Basis of Allotment is finalised in a fair and proper manner in accordance with the procedure specified in SEBI ICDR Regulations.

### **Method of allotment as may be prescribed by SEBI from time to time**

Our Company will not make any allotment in excess of the Equity Shares through this Prospectus and the Prospectus except in case of oversubscription for the purpose of rounding off to make allotment, in consultation with the Designated Stock Exchange. Further, upon oversubscription, an allotment of not more than one per cent of the Offer may be made for the purpose of making allotment in minimum lots.

The allotment of Equity Shares to applicants other than to the Retail Individual Bidders and Anchor Investors shall be on a proportionate basis within the respective investor categories and the number of securities allotted shall be rounded off to the nearest integer, subject to minimum allotment being equal to the minimum application size as determined and disclosed.

The allotment of Equity Shares to each Retail Individual Bidders shall not be less than the minimum bid lot, subject to the availability of shares in Retail Individual Bidders Portion, and the remaining available shares, if any, shall be allotted on a proportionate basis. The Allotment of Equity Shares to Anchor Investors shall be on a discretionary basis.

### **Payment into Escrow Account(s) for Anchor Investors**

Our Company and the Selling Shareholder (i.e. Rivendell PE LLC) in consultation with the BRLMs, in their absolute discretion, had decided the list of Anchor Investors to whom the CAN was sent, pursuant to which the details of the Equity Shares allocated to them in their respective names were notified to such Anchor Investors. For Anchor Investors, the payment instruments for payment into the Escrow Account(s) were to be drawn in favour of:

- (a) In case of resident Anchor Investors: “Rolex Rings Limited – IPO – Anchor Investor - R”
- (b) In case of Non-Resident Anchor Investors: “Rolex Rings Limited – IPO – Anchor Investor - NR”

Anchor Investors should note that the escrow mechanism is not prescribed by SEBI and has been established as an arrangement between our Company, the Selling Shareholder (i.e. Rivendell PE LLC) and the members of Syndicate, the Escrow Collection Bank and the Registrar to the Offer to facilitate collections of Bid amounts from Anchor Investors.

### **Pre-Offer Advertisement**

Subject to Section 30 of the Companies Act, 2013, our Company shall, after filing this Prospectus with the RoC, publish a pre- Offer advertisement, in the form prescribed by the SEBI ICDR Regulations, in: (i) all editions of Financial Express, an English national daily newspaper, (ii) all editions of Jansatta, a Hindi national daily newspaper, and (iii) Gujarat editions of Jaihind, a Gujarati newspaper, Gujarati being the regional language of Gujarat, where our Registered Office is located, each with wide circulation.

In the pre-Offer advertisement, we shall state the Bid/Offer Opening Date and the Bid/ Offer Closing Date. This advertisement, subject to the provisions of Section 30 of the Companies Act, 2013, shall be in the format prescribed in Part A of Schedule X of the SEBI ICDR Regulations.

### **Signing of the Underwriting Agreement and the RoC Filing**

- (a) Our Company, the Selling Shareholder (i.e. Rivendell PE LLC) and the Underwriters intend to enter into an Underwriting Agreement on or immediately after the finalisation of the Offer Price but prior to the filing of Prospectus.
- (b) After signing the Underwriting Agreement, an updated Red Herring Prospectus will be filed with the RoC in accordance with applicable law, which then would be termed as the ‘Prospectus’. The Prospectus

will contain details of the Offer Price, the Anchor Investor Offer Price, Offer size, and underwriting arrangements and will be complete in all material respects.

### **Undertakings by our Company**

Our Company undertakes the following:

- adequate arrangements shall be made to collect all Bid cum Application Forms submitted by Bidders and Anchor Investor Application Form from Anchor Investors;
- the complaints received in respect of the Offer shall be attended to by our Company expeditiously and satisfactorily;
- all steps for completion of the necessary formalities for listing and commencement of trading at all the Stock Exchanges where the Equity Shares are proposed to be listed shall be taken within six Working Days of the Bid/Offer Closing Date or such other period as may be prescribed by the SEBI;
- if Allotment is not made within the prescribed time period under applicable law, the entire subscription amount received will be refunded/unblocked within the time prescribed under applicable law. If there is delay beyond the prescribed time, our Company shall pay interest prescribed under the Companies Act, 2013, the SEBI ICDR Regulations and applicable law for the delayed period;
- the funds required for making refunds to unsuccessful Bidders as per the mode(s) disclosed shall be made available to the Registrar to the Offer by our Company;
- where refunds (to the extent applicable) are made through electronic transfer of funds, a suitable communication shall be sent to the applicant within the time prescribed under applicable law, giving details of the bank where refunds shall be credited along with amount and expected date of electronic credit of refund;
- Except for Equity Shares allotted pursuant to the Offer, no further issue of the Equity Shares shall be made till the Equity Shares offered through this Prospectus are listed or until the Bid monies are unblocked in ASBA Account/refunded on account of non-listing, under-subscription, etc.
- that adequate arrangements shall be made to collect all Bid cum Application Forms submitted by Bidders and Anchor Investor Application Form from Anchor Investors;
- Our Company and the Selling Shareholder (i.e. Rivendell PE LLC), in consultation with the BRLMs, reserves the right not to proceed with the Fresh Issue, in whole or in part thereof, to the extent of the Offered Shares, after the Bid/ Offer Opening Date but before the Allotment. In such an event, our Company would issue a public notice in the newspapers in which the pre-Offer advertisements were published, within two days of the Bid/ Offer Closing Date or such other time as may be prescribed by SEBI, providing reasons for not proceeding with the Offer and inform the Stock Exchanges promptly on which the Equity Shares are proposed to be listed; and
- If our Company and the Selling Shareholder (i.e. Rivendell PE LLC), in consultation with the BRLMs withdraws the Offer after the Bid/ Offer Closing Date and thereafter determines that it will proceed with an issue of the Equity Shares, our Company shall file a fresh draft red herring prospectus with SEBI.

### **Undertakings by the Selling Shareholder**

The Selling Shareholder (i.e. Rivendell PE LLC) undertakes in respect of itself as a selling shareholder (i.e. Rivendell PE LLC) and its respective portion of the Equity Shares offered by it in the Offer for Sale that:

- the Equity Shares offered for sale by the Selling Shareholder (i.e. Rivendell PE LLC) in the Offer are eligible for being offered in the Offer for Sale in terms of Regulation 8 of the SEBI ICDR Regulations;
- it is the legal and beneficial owner of the Offered Shares and the Equity Shares being offered for sale by the Selling Shareholder (i.e. Rivendell PE LLC) pursuant to the Offer are free and clear of any pre-

emptive rights, liens, mortgages, charges, pledges or any other encumbrances and shall be in dematerialized form at the time of transfer;

- it shall deposit its Equity Shares offered for sale in the Offer in an escrow demat in accordance with the share escrow agreement to be executed between the parties to such share escrow agreement;
- that it shall provide such reasonable assistance to our Company and the BRLMs in redressal of such investor grievances that pertain to the Equity Shares held by it and being offered pursuant to the Offer;
- it shall provide such reasonable cooperation to our Company in relation to the Equity Shares offered by it in the Offer for Sale for the completion of the necessary formalities for listing and commencement of trading at the Stock Exchanges; and
- it shall not have recourse to the proceeds of the Offer until final approval for trading of the Equity Shares from the Stock Exchanges has been received.

The decisions with respect to the Price Band, the minimum Bid lot, revision of Price Band, Offer Price, will be taken by our Company and the Selling Shareholder (i.e. Rivendell PE LLC) in consultation with the BRLMs.

### **Impersonation**

Attention of the applicants is specifically drawn to the provisions of sub-section (1) of Section 38 of the Companies Act, which is reproduced below:

*“Any person who—*

*(a) makes or abets making of an application in a fictitious name to a company for acquiring, or subscribing for, its securities; or*

*(b) makes or abets making of multiple applications to a company in different names or in different combinations of his name or surname for acquiring or subscribing for its securities; or*

*(c) otherwise induces directly or indirectly a company to allot, or register any transfer of, securities to him, or to any other person in a fictitious name*

*shall be liable for action under Section 447.”*

The liability prescribed under Section 447 of the Companies Act, for fraud involving an amount of at least ₹ 1 million or 1% of the turnover of the company, whichever is lower, includes imprisonment for a term which shall not be less than six months extending up to 10 years and fine of an amount not less than the amount involved in the fraud, extending up to three times such amount (provided that where the fraud involves public interest, such term shall not be less than three years.) Further, where the fraud involves an amount less than ₹ 1 million or one per cent of the turnover of the company, whichever is lower, and does not involve public interest, any person guilty of such fraud shall be punishable with imprisonment for a term which may extend to five years or with fine which may extend to ₹ 5 million or with both.

### **Depository Arrangement**

Pursuant to Section 29 of the Companies Act, 2013 the Equity Shares shall be Allotted only in dematerialised form. As per the SEBI ICDR Regulations, the trading of the Equity Shares shall only be in dematerialised form on the Stock Exchanges. In this context, our Company has entered into the following agreements with the respective Depositories and Registrar to the Offer:

- Tripartite agreement dated June 16, 2015 amongst our Company, NSDL and Registrar to the Offer.
- Tripartite agreement dated April 16, 2015 amongst our Company, CDSL and Registrar to the Offer.

### **Utilisation of Offer Proceeds**

Our Board of Directors certifies and declares that:

- all monies received out of the Fresh Issue shall be credited/transferred to a separate bank account other than the bank account referred to in sub-section (3) of Section 40 of the Companies Act, 2013;

- details of all monies utilised out of the Offer shall be disclosed, and continue to be disclosed till the time any part of the Fresh Issue proceeds remains unutilised, under an appropriate head in the balance sheet of our Company indicating the purpose for which such monies have been utilised; and
- details of all unutilised monies out of the Fresh Issue, if any shall be disclosed under an appropriate separate head in the balance sheet indicating the form in which such unutilised monies have been invested.

## RESTRICTIONS ON FOREIGN OWNERSHIP OF INDIAN SECURITIES

Foreign investment in Indian securities is regulated through the Industrial Policy, 1991 of the Government of India and FEMA. While the Industrial Policy, 1991 prescribes the limits and the conditions subject to which foreign investment can be made in different sectors of the Indian economy, FEMA regulates the precise manner in which such investment may be made. Foreign investment is permitted (except in the prohibited sectors) in Indian companies, either through the automatic route or the approval route, depending upon the sector in which foreign investment is sought to be made. The Government of India makes policy announcements on FDI through press notes and press releases. The regulatory framework, over a period of time, thus, consists of acts, regulations, press notes, press releases, and clarifications among other amendments. The consolidated FDI policy circular of 2020 dated October 15, 2020 issued by the DPIIT (formerly Department of Industrial Policy & Promotion) (“**FDI Circular**”) consolidates the policy framework which was in force as on October 15, 2020. Further, the FDI Circular consolidates and subsumes all the press notes, press releases, and clarifications on FDI issued by DPIIT. The FDI Circular will be valid until the DPIIT issues an updated circular and shall be subject to FEMA Non-debt Instruments Rules.

In terms of Press Note 3 of 2020, dated April 17, 2020 (“**Press Note**”), issued by the DPIIT, the FDI Circular has been amended to state that all investments under the foreign direct investment route by entities of a country which shares land border with India or where the beneficial owner of an investment into India is situated in or is a citizen of any such country will require prior approval of the Government of India. Further, in the event of transfer of ownership of any existing or future foreign direct investment in an entity in India, directly or indirectly, resulting in the beneficial ownership falling within the aforesaid restriction/ purview, such subsequent change in the beneficial ownership will also require approval of the Government of India. Furthermore, on April 22, 2020, the Ministry of Finance, Government of India has also made similar amendment to the FEMA Non-debt Instruments Rules.

As per the FDI Circular read with Press Note, 100% foreign direct investment is permitted under the automatic route for manufacturing companies, however, investments under the foreign direct investment route by entities of a country which shares land border with India or where the beneficial owner of an investment into India is situated in or is a citizen of any such country will require prior approval of the Government of India.

Transfer of shares between an Indian resident and a non-resident does not require the prior approval of the RBI, provided that (i) the activities of the investee company are under the automatic route under the FDI Circular and transfer does not attract the provisions of the SEBI Takeover Regulations; (ii) the non-resident shareholding is within the sectoral limits under the FDI Circular; and (iii) the pricing is in accordance with the guidelines prescribed by the SEBI/RBI.

For details of the aggregate limit for investments by NRIs and FPIs in our Company, see “*Offer Procedure – Bids by Eligible NRIs*” and “*Offer Procedure – Bids by FPIs*” on page 284 and 285, respectively.

As per the existing policy of the Government of India, OCBs cannot participate in this Offer.

**The Equity Shares have not been and will not be registered, listed or otherwise qualified in any other jurisdiction outside India and may not be offered or sold, and Bids may not be made by persons in any such jurisdiction, except in compliance with the applicable laws of such jurisdiction.**

**The above information is given for the benefit of the Bidders. Our Company and the BRLMs are not liable for any amendments or modification or changes in applicable laws or regulations, which may occur after the date of this Prospectus. Bidders are advised to make their independent investigations and ensure that the number of Equity Shares Bid for do not exceed the applicable limits under laws or regulations.**

## SECTION VIII - MAIN PROVISIONS OF THE ARTICLES OF ASSOCIATION

*The Articles of the Company comprise of two parts, Part A and Part B, which shall be applicable in the following manner:*

*(a) Till the time of listing and trading of Equity Shares of the Company on a recognised stock exchange in India, Part A and Part B shall, unless the context otherwise requires, co-exist with each other. Notwithstanding anything contained herein, in the event of any conflict between the provisions of Part A and Part B of these Articles, the provisions of Part B of these Articles shall prevail.*

*(b) Part B shall automatically terminate, be deleted and cease to have any force and effect upon the listing of shares of the Company proposed to be transferred/ issued pursuant to an initial public offering of the shares of the Company on a recognised stock exchange in India, without any further action by the Company, the Board of Directors or by the Shareholders.*

### PART A

1.	(1)	The regulations contained in the Table marked ‘F’ in Schedule I to the Act shall not apply to the Company, except in so far as the same are repeated, contained or expressly made applicable in these Articles or by the said Act.	Table ‘F’ not to apply
	(2)	The regulations for the management of the Company and for the observance by the members thereto and their representatives, shall, subject to any exercise of the statutory powers of the Company with reference to the deletion or alteration of or addition to its regulations by resolution as prescribed or permitted by the Companies Act, 2013, be such as are contained in these Articles.	Company to be governed by these Articles
Definitions and Interpretation			
2.	(1)	In these Articles —	
		(a) <b>“Act”</b> means the Companies Act, 2013 (including the relevant rules framed thereunder) or any statutory modification or re-enactment thereof for the time being in force and the term shall be deemed to refer to the applicable section thereof which is relatable to the relevant Article in which the said term appears in these Articles and any previous company law, so far as may be applicable.	“Act”
		(b) <b>“Applicable Laws”</b> means all applicable statutes, laws, ordinances, rules and regulations, judgments, notifications circulars, orders, decrees, bye-laws, guidelines, or any decision, or determination, or any interpretation, policy or administration, having the force of law, including but not limited to, any authorization by any authority, in each case as in effect from time to time	“Applicable Laws”
		(c) <b>“Articles”</b> means these articles of association of the Company or as altered from time to time.	“Articles”
		(d) <b>“Board of Directors”</b> or <b>“Board”</b> , means the collective body of the Directors of the Company nominated and appointed from time to time in accordance with Articles 84 to 90, herein, as may be applicable.	“Board of Directors” or “Board”
		(e) <b>“Company”</b> means <b>Rolex Rings Limited</b>	“Company”
		(f) <b>“Investor”</b> means Rivendell PE LLC (formerly NSR-PE Mauritius LLC) includes its Successor	
		(f) <b>“Lien”</b> means any mortgage, pledge, charge, assignment, hypothecation, security interest, title retention, preferential right, option (including call commitment), trust arrangement, any voting rights, right of set-off, counterclaim or banker’s lien, privilege or priority of any kind having the effect of security, any designation of loss payees or beneficiaries or any similar arrangement under or with respect to any insurance policy;	“Lien”
		(g) <b>“Rules”</b> means the applicable rules for the time being in force as prescribed under relevant sections of the Act.	“Rules”
		(h) <b>“Memorandum”</b> means the memorandum of association of the Company or as altered from time to time.	“Memorandum”
	(2)	Words importing the singular number shall include the plural number and words importing the masculine gender shall, where the context admits, include the feminine and neuter gender.	“Number” and “Gender”
	(3)	Unless the context otherwise requires, words or expressions contained in these Articles shall bear the same meaning as in the Act or the Rules, as the case may be.	Expressions in the Articles to bear the same meaning as in the Act

Share capital and variation of rights

3.	The authorized share capital of the Company shall be such amount and be divided into such shares as may from time to time, be provided in Clause V of Memorandum with power to reclassify, subdivide, consolidate and increase and with power from time to time, to issue any shares of the original capital or any new capital and upon the sub-division of shares to apportion the right to participate in profits, in any manner as between the shares resulting from sub-division.	Authorized share capital
4.	Subject to the provisions of the Act and these Articles, the shares in the capital of the Company shall be under the control of the Board who may issue, allot or otherwise dispose of the same or any of them to such persons, in such proportion and on such terms and conditions and either at a premium or at par (subject to the compliance with the provision of section 53 of the Act) and at such time as they may from time to time think fit provided that the option or right to call for shares shall not be given to any person or persons without the sanction of the Company in the general meeting.	Shares under control of Board
5.	Subject to the provisions of the Act, these Articles and with the sanction of the Company in the general meeting to give to any person or persons the option or right to call for any shares either at par or premium during such time and for such consideration as the Board think fit, the Board may issue, allot or otherwise dispose shares in the capital of the Company on payment or part payment for any property or assets of any kind whatsoever sold or transferred, goods or machinery supplied or for services rendered to the Company in the conduct of its business and any shares which may be so allotted may be issued as fully paid-up or partly paid-up otherwise than for cash, and if so issued, shall be deemed to be fully paid-up or partly paid-up shares, as the case may be, provided that the option or right to call of shares shall not be given to any person or persons without the sanction of the Company in the general meeting.	Board may allot shares otherwise than for cash
5A	The Company may issue the following kinds of shares in accordance with these Articles, the Act, the Rules and other Applicable Laws:  (a) Equity Share capital:  (i) with voting rights; and / or  (ii) with differential rights as to dividend, voting or otherwise in accordance with the Rules; and  (b) Preference share capital	Kinds of share capital
6.	(1) Every person whose name is entered as a member in the register of members shall be entitled to receive within two months after allotment or within one month from the date of receipt by the Company of the application for the registration of transfer or transmission, sub-division, consolidation or renewal of shares or within such other period as the conditions of issue shall provide –  (a) one or more certificates in marketable lots for all his shares of each class or denomination registered in his name without payment of any charges; or  (b) several certificates, each for one or more of his shares, upon payment of Rupees Twenty for each certificate or such charges as may be fixed by the Board for each certificate after the first.	Issue of certificate
	(2) In respect of any share or shares held jointly by several persons, the Company shall not be bound to issue more than one certificate, and delivery of a certificate for a share to the person first named on the register of members shall be sufficient delivery to all such holders.	Issue of share certificate in case of joint holding
	(3) Every certificate shall specify the shares to which it relates, distinctive numbers of shares in respect of which it is issued and the amount paid-up thereon and shall be in such form as the Board may prescribe and approve.	Option to receive share certificate or hold shares with depository
7.	A person subscribing to shares offered by the Company shall have the option either to receive certificates for such shares or hold the shares in a dematerialized state with a depository, in which event the rights and obligations of the parties concerned and matters connected therewith or incidental thereof, shall be governed by the provisions of the Depositories Act, 1996 as amended from time to time, or any statutory modification thereto or re-enactment thereof. Where a person opts to hold any share with the depository, the Company shall intimate such depository the details of allotment of the share to enable the depository to enter in its records the name of such person as the beneficial owner of that share.	Option to receive share certificate or hold shares with depository

	The Company shall also maintain a register and index of beneficial owners in accordance with all applicable provisions of the Companies Act, 2013 and the Depositories Act, 1996 with details of shares held in dematerialized form in any medium as may be permitted by law including in any form of electronic medium.	
8.	<p>If any certificate be worn out, defaced, mutilated or torn or if there be no further space on the back for endorsement of transfer, then upon production and surrender thereof to the Company, a new certificate may be issued in lieu thereof, and if any certificate is lost or destroyed then upon proof thereof to the satisfaction of the Company and on execution of such indemnity as the Board deems adequate, a new certificate in lieu thereof shall be given. Every certificate under this Article shall be issued on payment of fees not less than Rupees twenty and not more than Rupees fifty for each certificate as may be fixed by the Board.</p> <p>Provided that no fee shall be charged for issue of new certificates in replacement of those which are old, defaced or worn out or where there is no further space on the back thereof for endorsement of transfer.</p> <p>Provided that notwithstanding what is stated above, the Board shall comply with such rules or regulations or requirements of any stock exchange or the rules made under the Act or rules made under the Securities Contracts (Regulation) Act, 1956 or any other act, or rules applicable thereof in this behalf.</p>	Issue of new certificate in place of one defaced, lost or destroyed
8A	Except as required by Applicable Laws, no person shall be recognized by the Company as holding any share upon any trust, and the Company shall not be bound by, or be compelled in any way to recognize (even when having notice thereof) any equitable, contingent, future or partial interest in any share, or any interest in any fractional part of a share, or (except only as by these Articles or by Applicable Laws) any other rights in respect of any share except an absolute right to the entirety thereof in the registered holder.	
8B	Subject to the applicable provisions of the Act and other Applicable Laws, any debentures, debenture-stock or other securities may be issued at a premium or otherwise and may be issued on condition that they shall be convertible into shares of any denomination, and with any privileges and conditions as to redemption, surrender, drawing, allotment of shares and attending (but not voting) at a general meeting, appointment of nominee directors, etc. Debentures with the right to conversion into or allotment of shares shall be issued only with the consent of the Company in a general meeting by special resolution.	Terms of issue of debentures
9.	The provisions of the foregoing Articles relating to issue of certificates shall mutatis mutandis apply to issue of certificates for any other securities including debentures (except where the Act otherwise requires) of the Company.	Provisions as to issue of certificates to apply mutatis mutandis to debentures, etc.
10.	(1) The Company may exercise the powers of paying commissions conferred by the Act, to any person in connection with the subscription to its securities, provided that the rate per cent or the amount of the commission paid or agreed to be paid shall be disclosed in the manner required by the Act and the Rules.	Power to pay commission in connection with securities issued
	(2) The rate or amount of the commission shall not exceed the rate or amount prescribed in the Rules.	Rate of commission in accordance with Rules
	(3) The commission may be satisfied by the payment of cash or the allotment of fully or partly paid shares or partly in the one way and partly in the other.	Mode of payment of commission
11.	(1) If at any time the share capital is divided into different classes of shares, the rights attached to any class (unless otherwise provided by the terms of issue of the shares of that class) may, subject to the provisions of the Act, and whether or not the Company is being wound up, be varied with the consent in writing, of such number of the holders of the issued shares of that class, or with the sanction of a resolution passed at a separate meeting of the holders of the shares of that class, as prescribed by the Act.	Variation of members' rights
	(2) To every such separate meeting, the provisions of these Articles relating to general meetings shall mutatis mutandis apply.	Provisions as to general meetings to apply mutatis mutandis to each Meeting
12.	The rights conferred upon the holders of the shares of any class issued with preferred or other rights shall not, unless otherwise expressly provided by the terms of issue of the shares of that class, be deemed to be varied by the creation or issue of further shares ranking pari passu therewith.	Issue of further shares not to affect rights of existing members
13.	Subject to section 55 and other provisions of the Act, the Board shall have the power to issue or re-issue preference shares of one or more classes which are	Power to issue redeemable preference



		liable to be redeemed, or converted to equity shares, on such terms and conditions and in such manner as determined by the Board in accordance with the Act.	shares
14.	(1)	<p>Where at any time, the Company proposes to increase its subscribed capital by issue of further shares, either out of the unissued capital or the increased share capital, such shares shall be offered:</p> <p>to persons who, at the date of offer, are holders of Equity Shares of the Company, in proportion as near as circumstances admit, to the share capital paid up on those shares by sending a letter of offer on the following conditions : -</p> <p>the aforesaid offer shall be made by a notice specifying the number of shares offered and limiting a time prescribed under the Act from the date of the offer within which the offer, if not accepted, will be deemed to have been declined</p> <p>the aforementioned offer shall be deemed to include a right exercisable by the person concerned to renounce the shares offered to him or any of them in favour of any other person and the notice mentioned in sub-Article (i), above shall contain a statement of this right; and</p> <p>after the expiry of the time specified in the aforesaid notice or on receipt of earlier intimation from the person to whom such notice is given that he declines to accept the shares offered, the Board of Directors may dispose of them in such manner which is not disadvantageous to the shareholders and the Company; or</p> <p>to employees under any scheme of employees' stock option, subject to a special resolution passed by the Company and subject to the conditions as specified under the Act and Rules thereunder; or</p> <p>to any persons, if it is authorized by a special resolution passed by the Company in a General Meeting, whether or not those persons include the persons referred to in clause (a) or clause (b) above, either for cash or for consideration other than cash, subject to applicable provisions of the Act and Rules thereunder.</p> <p>The notice referred to in sub-clause (i) of sub-Article (a) shall be dispatched through registered post or speed post or through electronic mode to all the existing Members at least 3 (three) days before the opening of the issue.</p> <p>The provisions contained in this Article shall be subject to the provisions of the section 42 and section 62 of the Act, the rules thereunder and other applicable provisions of the Act.</p>	Further issue of share capital
	(2)	<p>Nothing in this Article shall apply to the increase of the subscribed capital of the Company caused by the exercise of an option as a term attached to the debentures issued or loans raised by the Company to convert such debenture or loans into shares in the Company.</p> <p>Provided that the terms of issue of such debentures or loan containing such an option have been approved before the issue of such debenture or the raising of loan by a special resolution passed by the Company in general meeting.</p>	
	(3)	A further issue of shares may be made in any manner whatsoever as the Board may determine including by way of preferential offer or private placement, subject to and in accordance with the Act and the Rules.	Mode of further issue of shares
15.	(1)	<p>The Company shall have a first and paramount Lien –</p> <p>(a) on every share (not being a fully paid share) and upon the proceeds of sale thereof for all monies (whether presently payable or not) called, or payable at a fixed time, in respect of that share; and</p> <p>(b) on all shares (not being fully paid shares) standing registered in the name of a member, for all monies presently payable by him or his estate to the Company:</p> <p>Provided that the Board may at any time declare any share to be wholly or in part exempt from the provisions of this Article.</p> <p>Provided further that Company's lien, if any, on such partly paid shares, shall be restricted to money called or payable at a fixed price in respect of such shares.</p>	Company's lien on shares

	(2)	The Company's Lien, if any, on a share shall extend to all dividends or interest, as the case may be, payable and bonuses declared from time to time in respect of such shares for any money owing to the Company.	Lien to extend to dividends, etc.
	(3)	Unless otherwise agreed by the Board, the registration of a transfer of shares shall operate as a waiver of the Company's Lien.	Waiver of Lien in case of registration
16.		The Company may sell, in such manner as the Board thinks fit, any shares on which the Company has a Lien:  Provided that no sale shall be made—  (a) unless a sum in respect of which the Lien exists is presently payable; or  (b) until the expiration of fourteen days after a notice in writing stating and demanding payment of such part of the amount in respect of which the Lien exists as is presently payable, has been given to the registered holder for the time being of the share or to the person entitled thereto by reason of his death or insolvency or otherwise.	As to enforcing Lien by sale
17.	(1)	To give effect to any such sale, the Board may authorize some person to transfer the shares sold to the purchaser thereof.	Validity of sale
	(2)	The purchaser shall be registered as the holder of the shares comprised in any such transfer.	Purchaser to be registered holder
	(3)	The receipt of the Company for the consideration (if any) given for the share on the sale thereof shall (subject, if necessary, to execution of an instrument of transfer or a transfer by relevant system, as the case may be) constitute a good title to the share and the purchaser shall be registered as the holder of the share.	Validity of Company's receipt
	(4)	The purchaser shall not be bound to see to the application of the purchase money, nor shall his title to the shares be affected by any irregularity or invalidity in the proceedings with reference to the sale	Purchaser not affected
18.	(1)	The proceeds of the sale shall be received by the Company and applied in payment of such part of the amount in respect of which the Lien exists as is presently payable.	Application of proceeds of sale
	(2)	The residue, if any, shall, subject to a like Lien for sums not presently payable as existed upon the shares before the sale, be paid to the person entitled to the shares at the date of the sale.	Payment of residual money
19.		The provisions of these Articles relating to Lien shall mutatis mutandis apply to any other securities including debentures of the Company.	Provisions as to Lien to apply mutatis mutandis to debentures, etc.
Calls on shares			
20.	(1)	The Board may, from time to time, make calls upon the members in respect of any monies unpaid on their shares (whether on account of the nominal value of the shares or by way of premium) and not by the conditions of allotment thereof made payable at fixed times.	Board may make Calls
	(2)	Each member shall, subject to receiving at least fourteen days' notice specifying the time or times and place of payment, pay to the Company, at the time or times and place so specified, the amount called on his shares.	Notice of call
	(3)	A call may be revoked or postponed at the discretion of the Board	Revocation or postponement of call
21.		A call shall be deemed to have been made at the time when the resolution of the Board authorizing the call was passed and may be required to be paid by instalments.	Call to take effect from date of resolution
22.		The joint holders of a share shall be jointly and severally liable to pay all calls in respect thereof.	Liability of joint holders of shares
23.	(1)	If a sum called in respect of a share is not paid before or on the day appointed for payment thereof (the "due date"), the person from whom the sum is due shall pay interest thereon from the due date to the time of actual payment at such rate as may be fixed by the Board.	When interest on call or instalment payable
	(2)	The Board shall be at liberty to waive payment of any such interest wholly or in part.	Board may waive interest
24.	(1)	Any sum which by the terms of issue of a share becomes payable on allotment or at any fixed date, whether on account of the nominal value of the share or by way of premium, shall, for the purposes of these Articles, be deemed to be a call duly made and payable on the date on which by the terms of issue such sum becomes payable.	Sums deemed to be calls
	(2)	In case of non-payment of such sum, all the relevant provisions of these Articles as to payment of interest and expenses, forfeiture or otherwise shall apply as if such sum had become payable by virtue of a call duly made and notified.	Effect of nonpayment of sums

25.	<p>The Board –</p> <p>(a) may, if it thinks fit, subject to the provisions of the Act, receive from any member willing to advance the same, all or any part of the monies uncalled and unpaid upon any shares held by him; and</p> <p>(b) upon all or any of the monies so advanced, may (until the same would, but for such advance, become presently payable) pay interest at such rate as may be fixed by the Board. Nothing contained in this clause shall confer on the member (a) any right to participate in profits or dividends or (b) any voting rights in respect of the moneys so paid by him until the same would, but for such payment, become presently payable by him.</p> <p>The Directors may at any time repay the amount so advanced.</p>	Payment in anticipation of calls may carry interest
26.	If by the conditions of allotment of any shares, the whole or part of the amount of issue price thereof shall be payable by installments, then every such installment shall, when due, be paid to the Company by the person who, for the time being and from time to time, is or shall be the registered holder of the share or the legal representative of a deceased registered holder.	Installments on shares to be duly paid
27. 27.	<p>All calls shall be made on a uniform basis on all shares falling under the same class.</p> <p>Explanation: Shares of the same nominal value on which different amounts have been paid-up shall not be deemed to fall under the same class.</p>	Calls on shares of same class to be on uniform basis
28.	The provisions of these Articles relating to calls shall mutatis mutandis apply to any other securities including debentures of the Company.	Provisions as to calls to apply mutatis mutandis to debentures, etc.
Transfer of shares		
29. (1)	A common form of transfer shall be used and the instrument of transfer of any share in the Company shall be in writing which shall be duly executed by or on behalf of both the transferor and transferee and all provisions of section 56 of the Act and statutory modification thereof for the time being shall be duly complied with in respect of all transfer of shares and registration thereof.	Instrument of transfer to be executed by transferor and transferee
(2)	The transferor shall be deemed to remain a holder of the share until the name of the transferee is entered in the register of members in respect thereof.	
30.	<p>The Board may, subject to the right of appeal conferred by the section 58 of the Act decline to register –</p> <p>(a) the transfer of a share, not being a fully paid share, to a person of whom they do not approve; or</p> <p>(b) any transfer of shares on which the Company has a Lien.</p> <p>The registration of a transfer shall not be refused on the ground of the transferor being either alone or jointly with any other person or persons indebted to the Company on any account whatsoever.</p>	Board may refuse to register transfer
31.	<p>The Board may decline to recognize any instrument of transfer unless-</p> <p>(a) the instrument of transfer is duly executed and is in the form as prescribed in the Rules made under sub-section (1) of section 56 of the Act;</p> <p>(b) the instrument of transfer is accompanied by the certificate of the shares to which it relates, and such other evidence as the Board may reasonably require to show the right of the transferor to make the transfer; and</p> <p>(c) the instrument of transfer is in respect of only one class of shares.</p> <p>The registration of a transfer shall not be refused on the ground of the transferor being either alone or jointly with any other person or persons indebted to the Company on any account whatsoever.</p>	Board may decline to recognize instrument of transfer
32.	<p>On giving of previous notice of at least seven days or such lesser period in accordance with the Act and Rules made thereunder, the registration of transfers may be suspended at such times and for such periods as the Board may from time to time determine:</p> <p>Provided that such registration shall not be suspended for more than thirty days</p>	Transfer of shares when suspended

	at any one time or for more than forty five days in the aggregate in any year.	
33. A	Subject to the provisions of sections 58 and 59 of the Act, these Articles and other applicable provisions of the Act or any other Applicable Laws for the time being in force, the Board may refuse whether in pursuance of any power of the Company under these Articles or any other Applicable Laws to register the transfer of, or the transmission by operation of Applicable Laws of the right to, any shares or interest of a member in or debentures of the Company. The Company shall within one (1) month from the date on which the instrument of transfer, or the intimation of such transmission, as the case may be, was delivered to Company, or such other period as may be prescribed, send notice of the refusal to the transferee and the transferor or to the person giving intimation of such transmission, as the case may be, giving reasons for such refusal. Provided that, subject to provisions of Article 32, the registration of a transfer shall not be refused on the ground of the transferor being either alone or jointly with any other person or persons indebted to the Company on any account whatsoever. Transfer of shares/debentures in whatever lot shall not be refused.	Notice of refusal to register transfer
34.	The provisions of these Articles relating to transfer of shares shall mutatis mutandis apply to any other securities including debentures of the Company.	Provisions as to transfer of shares to apply mutatis mutandis to debentures, etc.
Transmission of shares		
35. (1)	On the death of a member, the survivor or survivors where the member was a joint holder, and his nominee or nominees or legal representatives where he was a sole holder, shall be the only persons recognized by the Company as having any title to his interest in the shares.	Title to shares on death of a member
(2)	Nothing in clause (1) shall release the estate of a deceased joint holder from any liability in respect of any share which had been jointly held by him with other persons.	Estate of deceased member liable
36. (1)	Any person becoming entitled to a share in consequence of the death or insolvency of a member may, upon such evidence being produced as may from time to time properly be required by the Board and subject as hereinafter provided, elect, either –  (a) to be registered himself as holder of the share; or  (b) to make such transfer of the share as the deceased or insolvent member could have made.	Transmission Clause
(2)	The Board shall, in either case, have the same right to decline or suspend registration as it would have had, if the deceased or insolvent member had transferred the share before his death or insolvency.	Board's right unaffected
37. (1)	If the person so becoming entitled shall elect to be registered as holder of the share himself, he shall deliver or send to the Company a notice in writing signed by him stating that he so elects.	Right to election of holder of share
(2)	If the person aforesaid shall elect to transfer the share, he shall testify his election by executing a transfer of the share.	Manner of testifying election
(3)	All the limitations, restrictions and provisions of these regulations relating to the right to transfer and the registration of transfers of shares shall be applicable to any such notice or transfer as aforesaid as if the death or insolvency of the member had not occurred and the notice or transfer were a transfer signed by that member.	Limitations applicable to notice
38.	A person becoming entitled to a share by reason of the death or insolvency of the holder shall be entitled to the same dividends and other advantages to which he would be entitled if he were the registered holder of the share, except that he shall not, before being registered as a member in respect of the share, be entitled in respect of it to exercise any right conferred by membership in relation to meetings of the Company:  Provided that the Board may, at any time, give notice requiring any such person to elect either to be registered himself or to transfer the share, and if the notice is not complied with within ninety days, the Board may thereafter withhold payment of all dividends, bonuses or other monies payable in respect of the share, until the requirements of the notice have been complied with.	Claimant to be entitled to same advantage
39.	The provisions of these Articles relating to transmission by operation of law shall mutatis mutandis apply to any other securities including debentures of the	Provisions as to transmission to apply

	Company	mutatis mutandis to debentures, etc.
39A	No fee shall be charged for registration of transfer, transmission, probate, succession certificate and letters of administration, certificate of death or marriage, power of attorney or similar other document	No fee for transfer or transmission
Forfeiture of shares		
40.	If a member fails to pay any call, or instalment of a call or any money due in respect of any share, on the day appointed for payment thereof, the Board may, at any time thereafter during such time as any part of the call or instalment remains unpaid or a judgement or decree in respect thereof remains unsatisfied in whole or in part, serve a notice on him requiring payment of so much of the call or instalment or other money as is unpaid, together with any interest which may have accrued and all expenses that may have been incurred by the Company by reason of non-payment.	If call or instalment not paid notice must be given
41.	The notice aforesaid shall:  (a) name a further day (not being earlier than the expiry of fourteen days from the date of service of the notice) on or before which the payment required by the notice is to be made; and  (b) state that, in the event of non-payment on or before the day so named, the shares in respect of which the call was made shall be liable to be forfeited.	Form of Notice
42.	If the requirements of any such notice as aforesaid are not complied with, any share in respect of which the notice has been given may, at any time thereafter, before the payment required by the notice has been made, be forfeited by a resolution of the Board to that effect.	In default of payment of shares to be forfeited
43.	When any share shall have been so forfeited, notice of the forfeiture shall be given to the defaulting member and an entry of the forfeiture with the date thereof, shall forthwith be made in the register of members.	Entry of forfeiture in register of members
44.	The forfeiture of a share shall involve extinction at the time of forfeiture, of all interest in and all claims and demands against the Company, in respect of the share and all other rights incidental to the share.	Effect of forfeiture
45.	(1) A forfeited share shall be deemed to be the property of the Company and may be sold or re-allotted or otherwise disposed of either to the person who was before such forfeiture the holder thereof or entitled thereto or to any other person on such terms and in such manner as the Board thinks fit.	Forfeited shares may be sold, etc.
	(2) At any time before a sale, re-allotment or disposal as aforesaid, the Board may cancel the forfeiture on such terms as it thinks fit.	Cancellation of forfeiture
46.	(1) A person whose shares have been forfeited shall cease to be a member in respect of the forfeited shares, but shall, notwithstanding the forfeiture, remain liable to pay, and shall pay, to the Company all monies which, at the date of forfeiture, were presently payable by him to the Company in respect of the shares.	Members still liable to pay money owing at the time of forfeiture
	(2) The liability of such person shall cease if and when the Company shall have received payment in full of all such monies in respect of the shares.	Cesser of liability
47.	(1) A duly verified declaration in writing that the declarant is a director, the manager or the secretary of the Company, and that a share in the Company has been duly forfeited on a date stated in the declaration, shall be conclusive evidence of the facts therein stated as against all persons claiming to be entitled to the share;	Certificate of forfeiture
	(2) The Company may receive the consideration, if any, given for the share on any sale, re-allotment or disposal thereof and may execute a transfer of the share in favour of the person to whom the share is sold or disposed of;	Title of purchaser and transferee of forfeited shares
	(3) The transferee shall thereupon be registered as the holder of the share; and	Transferee to be registered as holder
	(4) The transferee shall not be bound to see to the application of the purchase money, if any, nor shall his title to the share be affected by any irregularity or invalidity in the proceedings in reference to the forfeiture, sale, re-allotment or disposal of the share.	Transferee not affected
48.	Upon any sale after forfeiture or for enforcing a Lien in exercise of the powers hereinabove given, the Board may, if necessary, appoint some person to execute an instrument for transfer of the shares sold and cause the purchaser's name to be entered in the register of members in respect of the shares sold and after his name has been entered in the register of members in respect of such shares the validity of the sale shall not be impeached by any person.	Validity of sales
49.	Upon any sale, re-allotment or other disposal under the provisions of the preceding Articles, the certificate(s), if any, originally issued in respect of the relative shares shall (unless the same shall on demand by the Company has been	Cancellation of share certificate in respect of forfeited shares

	previously surrendered to it by the defaulting member) stand cancelled and become null and void and be of no effect, and the Board shall be entitled to issue a duplicate certificate(s) in respect of the said shares to the person(s) entitled thereto.	
50.	The Board may, subject to the provisions of the Act, accept a surrender of any share from or by any member desirous of surrendering them on such terms as they think fit.	Surrender of share certificates
51.	The provisions of these Articles as to forfeiture shall apply in the case of non-payment of any sum which, by the terms of issue of a share, becomes payable at a fixed time, whether on account of the nominal value of the share or by way of premium, as if the same had been payable by virtue of a call duly made and notified.	Sums deemed to be calls
52.	The provisions of these Articles relating to forfeiture of shares shall mutatis mutandis apply to any other securities including debentures of the Company.	Provisions as to forfeiture of shares to apply mutatis mutandis to debentures, etc.
<b>Alteration of capital</b>		
53.	<p>Subject to the provisions of the Act, the Company may, by ordinary resolution -</p> <p>(a) increase the share capital by such sum, to be divided into shares of such amount as it thinks expedient;</p> <p>(b) consolidate and divide all or any of its share capital into shares of larger amount than its existing shares:</p> <p>Provided that any consolidation and division which results in changes in the voting percentage of members shall require applicable approvals under the Act;</p> <p>(c) convert all or any of its fully paid-up shares into stock, and reconvert that stock into fully paid-up shares of any denomination;</p> <p>(d) sub-divide its existing shares or any of them into shares of smaller amount than is fixed by the Memorandum;</p> <p>(e) cancel any shares which, at the date of the passing of the resolution, have not been taken or agreed to be taken by any person.</p>	Power to alter share capital
54.	<p>Where shares are converted into stock:</p> <p>(a) the holders of stock may transfer the same or any part thereof in the same manner as, and subject to the same Articles under which, the shares from which the stock arose might before the conversion have been transferred, or as near thereto as circumstances admit:</p> <p>Provided that the Board may, from time to time, fix the minimum amount of stock transferable, so, however, that such minimum shall not exceed the nominal amount of the shares from which the stock arose;</p> <p>(b) the holders of stock shall, according to the amount of stock held by them, have the same rights, privileges and advantages as regards dividends, voting at meetings of the Company, and other matters, as if they held the shares from which the stock arose; but no such privilege or advantage (except participation in the dividends and profits of the Company and in the assets on winding up) shall be conferred by an amount of stock which would not, if existing in shares, have conferred that privilege or advantage;</p> <p>(c) such of these Articles of the Company as are applicable to paid-up shares shall apply to stock and the words “share” and “shareholder”/ “member” shall include “stock” and “stock-holder” respectively.</p>	Right of stockholders
55.	<p>The Company may, by resolution as prescribed by the Act, reduce in any manner and in accordance with the provisions of the Act and the Rules, —</p> <p>(a) its share capital; and/or</p> <p>(b) any capital redemption reserve account; and/or</p> <p>(c) any securities premium account; and/or</p>	Reduction of capital

	(d) any other reserve in the nature of share capital.	
56.	Where two or more persons are registered as joint holders (not more than three) of any share, they shall be deemed (so far as the Company is concerned) to hold the same as joint tenants with benefits of survivorship, subject to the following and other provisions contained in these Articles:	Joint holders
	(a) The joint-holders of any share shall be liable severally as well as jointly for and in respect of all calls or instalments and other payments which ought to be made in respect of such share.	Liability of Joint holders
	(b) On the death of any one or more of such joint-holders, the survivor or survivors shall be the only person or persons recognized by the Company as having any title to the share but the Board may require such evidence of death as they may deem fit, and nothing herein contained shall be taken to release the estate of a deceased joint-holder from any liability on shares held by him jointly with any other person.	Death of one or more joint-holders
	(c) Any one of such joint holders may give effectual receipts of any dividends, interests or other moneys payable in respect of such share.	Receipt of one Sufficient
	(d) Only the person whose name stands first in the register of members as one of the joint-holders of any share shall be entitled to the delivery of certificate, if any, relating to such share or to receive notice (which term shall be deemed to include all relevant documents) and any notice served on or sent to such person shall be deemed service on all the joint-holders.	Delivery of certificate and giving of notice to first named holder
	(e) (i) Any one of two or more joint-holders may vote at any meeting either personally or by attorney or by proxy in respect of such shares as if he were solely entitled thereto and if more than one of such joint holders be present at any meeting personally or by proxy or by attorney then that one of such persons so present whose name stands first or higher (as the case may be) on the register in respect of such shares shall alone be entitled to vote in respect thereof.	Vote of joint holders
	(ii) Several executors or administrators of a deceased member in whose (deceased member) sole name any share stands, shall for the purpose of this clause be deemed joint-holders.	Executors or administrators as joint holders
	(f) The provisions of these Articles relating to joint holders of shares shall mutatis mutandis apply to any other securities including debentures of the Company registered in joint names.	Provisions as to joint holders as to shares to apply mutatis mutandis to debentures, etc.
Capitalization of profits		
57.	(1) The Company by ordinary resolution in general meeting may, upon the recommendation of the Board, resolve —	Capitalization
	(a) that it is desirable to capitalize any part of the amount for the time being standing to the credit of any of the Company's reserve accounts, or to the credit of the profit and loss account, or otherwise available for distribution; and	
	(b) that such sum be accordingly set free for distribution in the manner specified in clause (2) below amongst the members who would have been entitled thereto, if distributed by way of dividend and in the same proportions.	
	(2) The sum aforesaid shall not be paid in cash but shall be applied, subject to the provision contained in clause (3) below, either in or towards:	Sum how applied
	(A) paying up any amounts for the time being unpaid on any shares held by such members respectively;	
	(B) paying up in full, unissued shares or other securities of the Company to be allotted and distributed, credited as fully paid-up, to and amongst such members in the proportions aforesaid;	
	(C) partly in the way specified in sub-clause (A) and partly in that specified in sub-clause (B).	
	(3) A securities premium account and a capital redemption reserve account or any other permissible reserve account may, for the purposes of this Article, be applied in the paying up of unissued shares to be issued to members of the Company as fully paid bonus shares;	
	(4) The Board shall give effect to the resolution passed by the Company in pursuance of these Article.	

58.	(1)	Whenever such a resolution as aforesaid shall have been passed, the Board shall –  (a) make all appropriations and applications of the amounts resolved to be capitalized thereby, and all allotments and issues of fully paid shares or other securities, if any; and  (b) generally do all acts and things required to give effect thereto.	Powers of the Board for capitalization
	(2)	The Board shall have power—  (a) to make such provisions, by the issue of fractional certificates/coupons or by payment in cash or otherwise as it thinks fit, for the case of shares or other securities becoming distributable in fractions; and  (b) to authorize any person to enter, on behalf of all the members entitled thereto, into an agreement with the Company providing for the allotment to them respectively, credited as fully paid-up, of any further shares or other securities to which they may be entitled upon such capitalization, or as the case may require, for the payment by the Company on their behalf, by the application thereto of their respective proportions of profits resolved to be capitalized, of the amount or any part of the amounts remaining unpaid on their existing shares.	Board's power to issue fractional certificate/coupon etc.
	(3)	Any agreement made under such authority shall be effective and binding on such members.	Agreement binding on members
Buy-back of shares			
59.		Notwithstanding anything contained in these Articles but subject to all applicable provisions of the Act or any other Applicable Laws for the time being in force, the Company may purchase its own shares or other specified securities.	Buy-back of shares
General meetings			
60.		All general meetings other than annual general meeting shall be called extraordinary general meeting.	Extraordinary general meeting
61.		The Board may, whenever it thinks fit, call an extraordinary general meeting.	Powers of Board to call extraordinary general meeting
Proceedings at general meetings			
62.		No business shall be transacted at any general meeting unless a quorum of members is present at the time when the meeting proceeds to business.	Presence of Quorum
63.		No business shall be discussed or transacted at any general meeting except election of Chairperson whilst the chair is vacant.	Business confined to election of Chairperson whilst chair vacant
64.		The quorum for a general meeting shall be as provided in the Act.	Quorum for general meeting
65.		If at any meeting no director is willing to act as Chairperson or if no director is present within fifteen minutes after the time appointed for holding the meeting, the members present shall, by poll or electronically, choose one of their members to be Chairperson of the meeting.	Members to elect a Chairperson
66.		On any business at any general meeting, in case of an equality of votes, whether on a show of hands or electronically or on a poll, the Chairperson shall have a second or casting vote.	Casting vote of Chairperson at general meeting
67.	(1)	The Company shall cause minutes of the proceedings of every general meeting of any class of members or creditors and every resolution passed by postal ballot to be prepared and signed in such manner as may be prescribed by the Rules and kept by making within thirty days of the conclusion of every such meeting concerned or passing of resolution by postal ballot entries thereof in books kept for that purpose with their pages consecutively numbered.	Minutes of proceedings of meetings and resolutions passed by postal ballot
	(2)	There shall not be included in the minutes any matter which, in the opinion of the Chairperson of the meeting –  (a) is, or could reasonably be regarded, as defamatory of any person; or  (b) is irrelevant or immaterial to the proceedings; or  (c) is detrimental to the interests of the Company.	Certain matters not to be included in Minutes
	(3)	The Chairperson shall exercise an absolute discretion in regard to the inclusion or non-inclusion of any matter in the minutes on the grounds specified in the aforesaid clause.	Discretion of Chairperson in relation to Minutes



	(4)	The minutes of the meeting kept in accordance with the provisions of the Act shall be evidence of the proceedings recorded therein.	Minutes to be Evidence
68.	(1)	The books containing the minutes of the proceedings of any general meeting of the Company or a resolution passed by postal ballot shall:  (a) be kept at the registered office of the Company; and  (b) be open to inspection of any member without charge, during business hours on all working days.	Inspection of minute books of general meeting
	(2)	Any member shall be entitled to be furnished, within the time prescribed by the Act, after he has made a request in writing in that behalf to the Company and on payment of such fees as may be fixed by the Board, with a copy of any minutes referred to in clause (1) above.	Members may obtain copy of minutes
Adjournment of meeting			
69.	(1)	The Chairperson may, suo motu, adjourn the meeting from time to time and from place to place.	Chairperson may adjourn the meeting
	(2)	No business shall be transacted at any adjourned meeting other than the business left unfinished at the meeting from which the adjournment took place.	Business at adjourned meeting
	(3)	When a meeting is adjourned for thirty days or more, notice of the adjourned meeting shall be given as in the case of an original meeting.	Notice of adjourned meeting
	(4)	Save as aforesaid, and save as provided in the Act, it shall not be necessary to give any notice of an adjournment or of the business to be transacted at an adjourned meeting.	Notice of adjourned meeting not required
Voting rights			
70.		Subject to any rights or restrictions for the time being attached to any class or classes of shares -  (a) on a show of hands, every member present in person shall have one vote; and  (b) on a poll, the voting rights of members shall be in proportion to his share in the paid-up Equity Share capital of the company.	Entitlement to vote on show of hands and on poll
71.		A member may exercise his vote at a meeting by electronic means in accordance with the Act and shall vote only once.	Voting through electronic means
72.	(1)	In the case of joint holders, the vote of the senior who tenders a vote, whether in person or by proxy, shall be accepted to the exclusion of the votes of the other joint holders.	Vote of joint holders
	(2)	For this purpose, seniority shall be determined by the order in which the names stand in the register of members.	Seniority of names
73.		A member of unsound mind, or in respect of whom an order has been made by any court having jurisdiction in lunacy, may vote, whether on a show of hands or on a poll, by his committee or other legal guardian, and any such committee or guardian may, on a poll, vote by proxy. If any member be a minor, the vote in respect of his share or shares shall be by his guardian or any one of his guardians.	How members non compos mentis and minor may vote
74.		Any business other than that upon which a poll has been demanded may be proceeded with, pending the taking of the poll.	Business may proceed pending poll
75.		No member shall be entitled to vote at any general meeting unless all calls or other sums presently payable by him in respect of shares in the Company have been paid or in regard to which the Company has exercised any right of Lien.	Restriction on voting rights
76.		A member is not prohibited from exercising his voting on the ground that he has not held his share or other interest in the Company for any specified period preceding the date on which the vote is taken, or on any other ground not being a ground set out in the preceding Article.	Restriction on exercise of voting rights in other cases to be void
77.	77.	Any member whose name is entered in the register of members of the Company shall enjoy the same rights and be subject to the same liabilities as all other members of the same class.	Equal rights of members
Proxy			
78.	(1)	Any member entitled to attend and vote at a general meeting may do so either personally or through his constituted attorney or through another person as a proxy on his behalf, for that meeting.	Member may vote in person or otherwise
	(2)	The instrument appointing a proxy and the power-of attorney or other authority, if any, under which it is signed or a notarized copy of that power or authority, shall be deposited at the registered office of the Company not less than 48 hours before the time for holding the meeting or adjourned meeting at which the person named in the instrument proposes to vote, and in default the instrument of proxy	Proxies when to be deposited

	shall not be treated as valid.	
79.	An instrument appointing a proxy shall be in the form as prescribed in the Rules.	Form of proxy
80.	A vote given in accordance with the terms of an instrument of proxy shall be valid, notwithstanding the previous death or insanity of the principal or the revocation of the proxy or of the authority under which the proxy was executed, or the transfer of the shares in respect of which the proxy is given: Provided that no intimation in writing of such death, insanity, revocation or transfer shall have been received by the Company at its office before the commencement of the meeting or adjourned meeting at which the proxy is used.	Proxy to be valid notwithstanding death of the principal
Board of Directors		
81.	Unless otherwise determined by the Company in general meeting, the number of directors shall not be less than 3 (three) and shall not be more than fifteen (fifteen).	Board of Directors
81A	The provisions of this Article 81A shall be subject to and effective from the date of receipt of shareholders' approval, through a special resolution to this effect in a general meeting of the Company, following the listing and commencement of trading of Equity Shares on a recognized stock exchange pursuant to an initial public offering of Equity Shares of the Company.  Subject to applicable laws, statutory and regulatory approvals and these Articles, the Investor shall have the right by notice in writing to nominate 1 (one) Director to the Board till the time the Investor hold directly or indirectly an aggregate interest (including any beneficial interest) in the Shares which is equivalent to, or referenced to, 5% (five per cent) or more of the issued share capital of the Company, and by like notice to require the removal of such Director and the appointment of another person to act in place of such Director. Any such Director shall also, at the option of the Investor, be appointed as a member of all the committees and/or sub-committees formed by the Board of the Company.  In addition to the above, the Investor shall have the right to require the appointment of an Observer from time to time, who shall have the right to attend and speak at all Board meetings and receive all information and correspondence sent to or available to members of the Board but shall not be entitled to vote at any Board meetings (and shall not be deemed to be a Director of the Company for any purpose).	Investors' right to appoint a director and an observer
81B	The Directors shall not be required to hold any qualification shares in the Company.	
82.	(1) The Board of Directors shall appoint the Chairperson of the Company.  The same individual may, at the same time, be appointed as the Chairperson as well as the Managing Director of the Company.	Chairperson and Managing Director
	(2) The Board shall have the power to determine the directors whose period of office is or is not liable to determination by retirement of directors by rotation.	Directors not liable to retire by rotation
83.	(1) The remuneration of the directors shall, in so far as it consists of a monthly payment, be deemed to accrue from day-to-day.	Remuneration of Directors
	(2) The remuneration payable to the directors, including manager, if any, shall be determined in accordance with and subject to the provisions of the Act by an ordinary resolution passed by the Company in general meeting.	Remuneration to require members' consent
	(3) In addition to the remuneration payable to them in pursuance of the Act, the directors may be paid all travelling, hotel and other expenses properly incurred by them—  (a) in attending and returning from meetings of the Board of Directors or any committee thereof or general meetings of the Company; or  (b) in connection with the business of the Company.	Travelling and other expenses
	(4) Subject to the provisions of these Articles and the provisions of the Act, the Board may, decide to pay a Director out of funds of the Company by way of sitting fees, within the ceiling prescribed under the Act, a sum to be determined by the Board for each meeting of the Board or any committee or sub-committee thereof attended by him in addition to his traveling, boarding and lodging and other expenses incurred	Sitting Fees
APPOINTMENT AND REMUNERATION OF DIRECTORS		
84.	Subject to the provisions of the Act and these Articles, the Board of Directors, may from time to time, appoint one or more of the Directors to be Managing Director or Managing Directors or other whole-time Director(s) of the	Appointment

	Company, for a term not exceeding five years at a time and may, from time to time, (subject to the provisions of any contract between him or them and the Company) remove or dismiss him or them from office and appoint another or others in his or their place or places and the remuneration of Managing or Whole-Time Director(s) by way of salary and commission shall be in accordance with the relevant provisions of the Act.	
84A	Notwithstanding anything contained in these Articles including Article 81A, Rivendell PE LLC (formerly NSR-PE Mauritius LLC) would be entitled to appoint one non-executive director until they hold 5% of the post issued paid-up capital of the Company.	Investor Director
84B	Subject to the provisions of the Act, the Board shall appoint Independent Directors, who shall have appropriate experience and qualifications to hold a position of this nature on the Board.	Independent Director
85.	Subject to the provisions of section 196, 197 and 188 read with Schedule V to the Act, the Directors shall be paid such further remuneration, whether in the form of monthly payment or by a percentage of profit or otherwise, as the Company in General meeting may, from time to time, determine and such further remuneration shall be divided among the Directors in such proportion and in such manner as the Board may, from time to time, determine and in default of such determination shall be divided among the Directors equally or if so determined paid on a monthly basis.	Remuneration
86.	Subject to the provisions of these Articles, and the provisions of the Act, if any Director, being willing, shall be called upon to perform extra service or to make any special exertions in going or residing away from the place of his normal residence for any of the purposes of the Company or has given any special attendance for any business of the Company, the Company may remunerate the Director so doing either by a fixed sum or otherwise as may be determined by the Director	Payment for Extra Service
87.	All cheques, promissory notes, drafts, hundis, bills of exchange and other negotiable instruments, and all receipts for monies paid to the Company, shall be signed, drawn, accepted, endorsed, or otherwise executed, as the case may be, by such person and in such manner as the Board shall from time to time by resolution determine.	Execution of negotiable instruments
88.	(1) Subject to the provisions of the Act, the Board shall have power at any time, and from time to time, to appoint a person as an additional director, provided the number of the directors and additional directors together shall not at any time exceed the maximum strength fixed for the Board by the Articles.	Appointment of additional directors
	(2) Such person shall hold office only up to the date of the next annual general meeting of the Company but shall be eligible for appointment by the Company as a director at that meeting subject to the provisions of the Act.	Duration of office of additional director
89.	(1) The Board may appoint an alternate director to act for a director (hereinafter in this Article called "the Original Director") during his absence for a period of not less than three months from India. No person shall be appointed as an alternate director for an independent director unless he is qualified to be appointed as an independent director under the provisions of the Act.	Appointment of alternate director
	(2) An alternate director shall not hold office for a period longer than that permissible to the Original Director in whose place he has been appointed and shall vacate the office if and when the Original Director returns to India	Duration of office of alternate director
	(3) If the term of office of the Original Director is determined before he returns to India the automatic reappointment of retiring directors in default of another appointment shall apply to the Original Director and not to the alternate director.	Re-appointment provisions applicable to Original Director
90.	(1) If the office of any director appointed by the Company in general meeting is vacated before his term of office expires in the normal course, the resulting casual vacancy may, be filled by the Board of Directors at a meeting of the Board.	Appointment of director to fill a casual vacancy
	(2) The director so appointed shall hold office only up to the date upto which the director in whose place he is appointed would have held office if it had not been vacated.	Duration of office of Director appointed to fill casual vacancy
<b>Powers of Board</b>		
91.	The management of the business of the Company shall be vested in the Board and the Board may exercise all such powers, and do all such acts and things, as the Company is by the Memorandum or otherwise authorized to exercise and do, and, not hereby or by the statute or otherwise directed or required to be exercised or done by the Company in general meeting but subject nevertheless to the provisions of the Act and other Applicable Laws and of the Memorandum and these Articles and to any regulations, not being inconsistent with the	General powers of the Company vested in Board

	Memorandum and these Articles or the Act, from time to time made by the Company in general meeting provided that no such regulation shall invalidate any prior act of the Board which would have been valid if such regulation had not been made.	
Proceedings of the Board		
92.	(1) The Board of Directors may meet for the conduct of business, adjourn and otherwise regulate its meetings, as it thinks fit.  Provided, that the Board of Directors shall hold meetings at least once in every three months and at least four times every calendar year.	When meeting to be convened
	(2) The Chairperson or any one Director with the previous consent of the Chairperson may, or the company secretary on the direction of the Chairperson shall, at any time, summon a meeting of the Board.	Who may summon Board meeting
	(3) The quorum for a Board meeting shall be as provided in the Act.	Quorum for Board meetings
	(4) The participation of directors in a meeting of the Board may be either in person or through video conferencing or audio visual means or teleconferencing, as may be prescribed by the Rules or permitted under Applicable Laws.	Participation at Board meetings
	(5) At least 7 (seven) Days' written notice shall be given in writing to every Director by hand delivery or by speed-post or by registered post or by facsimile or by email or by any other electronic means, either (i) in writing, or (ii) by fax, e-mail or other approved electronic communication, receipt of which shall be confirmed in writing as soon as is reasonably practicable, to each Director, setting out the agenda for the meeting in reasonable detail and attaching the relevant papers to be discussed at the meeting and all available data and information relating to matters to be discussed at the meeting except as otherwise agreed in writing by all the Directors.	Notice of Board meetings
93.	(1) Save as otherwise expressly provided in the Act, questions arising at any meeting of the Board shall be decided by a majority of votes.	Questions at Board meeting how decided
	(2) In case of an equality of votes, the Chairperson of the Board, if any, shall have a second or casting vote.	Casting vote of Chairperson at Board meeting
94.	The continuing directors may act notwithstanding any vacancy in the Board; but, if and so long as their number is reduced below the quorum fixed by the Act for a meeting of the Board, the continuing directors or director may act for the purpose of increasing the number of directors to that fixed for the quorum, or of summoning a general meeting of the Company, but for no other purpose.	Directors not to act when number falls below minimum
95.	(1) The Chairperson of the Company shall be the Chairperson at meetings of the Board. In his absence, the Board may elect a Chairperson of its meetings and determine the period for which he is to hold office.	Who to preside at meetings of the Board
	(2) If no such Chairperson is elected, or if at any meeting the Chairperson is not present within fifteen minutes after the time appointed for holding the meeting, the directors present may choose one of their number to be Chairperson of the meeting	Directors to elect a Chairperson
96.	(1) The Board may, subject to the provisions of the Act, delegate any of its powers to Committees consisting of such member or members of its body as it thinks fit.	Delegation of powers
	(2) Any Committee so formed shall, in the exercise of the powers so delegated, conform to any regulations that may be imposed on it by the Board.	Committee to conform to Board regulations
	(3) The participation of directors in a meeting of the Committee may be either in person or through video conferencing or audio visual means or teleconferencing, as may be prescribed by the Rules or permitted under Applicable Laws.	Participation at Committee meetings
97.	(1) A Committee may elect a Chairperson of its meetings unless the Board, while constituting a Committee, has appointed a Chairperson of such Committee.	Chairperson of Committee
	(2) If no such Chairperson is elected, or if at any meeting the Chairperson is not present within fifteen minutes after the time appointed for holding the meeting, the members present may choose one of their members to be Chairperson of the meeting.	Who to preside at meetings of Committee
98.	(1) A Committee may meet and adjourn as it thinks fit.	Committee to meet
	(2) Questions arising at any meeting of a Committee shall be determined by a majority of votes of the members present.	Questions at Committee meeting how decided
	(3) In case of an equality of votes, the Chairperson of the Committee shall have a second or casting vote.	Casting vote of Chairperson at Committee meeting
99.	All acts done in any meeting of the Board or of a Committee thereof or by any	Acts of Board or

	person acting as a director, shall, notwithstanding that it may be afterwards discovered that there was some defect in the appointment of any one or more of such directors or of any person acting as aforesaid, or that they or any of them were disqualified or that his or their appointment had terminated, be as valid as if every such director or such person had been duly appointed and was qualified to be a director.	Committee valid notwithstanding defect of appointment
100.	Save as otherwise expressly provided in the Act, a resolution in writing, signed, whether manually or by secure electronic mode, by a majority of the members of the Board or of a Committee thereof, for the time being entitled to receive notice of a meeting of the Board or Committee, shall be valid and effective as if it had been passed at a meeting of the Board or Committee, duly convened and held.	Passing of resolution by Circulation
<b>Chief Executive Officer, Manager, Company Secretary and Chief Financial Officer</b>		
101. (a)	Subject to the provisions of the Act, -  A chief executive officer, manager, company secretary and chief financial officer may be appointed by the Board for such term, at such remuneration and upon such conditions as it may think fit; and any chief executive officer, manager, company secretary and chief financial officer so appointed may be removed by means of a resolution of the Board; the Board may appoint one or more chief executive officers for its multiple businesses.	Chief Executive Officer, etc.
(b)	A director may be appointed as chief executive officer, manager, company secretary or chief financial officer.	Director may be chief executive officer, etc.
<b>Registers</b>		
102.	The Company shall keep and maintain at its registered office all statutory registers namely, register of charges, register of members, register of debenture holders, register of any other security holders, the register and index of beneficial owners and annual return, register of loans, guarantees, security and acquisitions, register of investments not held in its own name and register of contracts and arrangements for such duration as the Board may, unless otherwise prescribed, decide, and in such manner and containing such particulars as prescribed by the Act and the Rules.  The registers and copies of annual return shall be open for inspection during business hours on all working days, at the registered office of the Company by the persons entitled thereto on payment, where required, of such fees as may be fixed by the Board but not exceeding the limits prescribed by the Rules.	Statutory registers
103. (a)	The Company may exercise the powers conferred on it by the Act with regard to the keeping of a foreign register; and the Board may (subject to the provisions of the Act) make and vary such regulations as it may think fit respecting the keeping of any such register.	Foreign register
(b)	The foreign register shall be open for inspection and may be closed, and extracts may be taken therefrom and copies thereof may be required, in the same manner, mutatis mutandis, as is applicable to the register of members.	
<b>Dividends and Reserve</b>		
104.	The Company in general meeting may declare dividends, but no dividend shall exceed the amount recommended by the Board but the Company in general meeting may declare a lesser dividend.	Company in general meeting may declare dividends
105.	Subject to the provisions of the Act, the Board may from time to time pay to the members such interim dividends of such amount on such class of shares and at such times as it may think fit.	Interim dividends
106. (1)	The Board may, before recommending any dividend, set aside out of the profits of the Company such sums as it thinks fit as a reserve or reserves which shall, at the discretion of the Board, be applied for any purpose to which the profits of the Company may be properly applied, including provision for meeting contingencies or for equalizing dividends; and pending such application, may, at the like discretion, either be employed in the business of the Company or be invested in such investments (other than shares of the Company) as the Board may, from time to time, think fit.	Dividends only to be paid out of profits
(2)	The Board may also carry forward any profits which it may consider necessary not to divide, without setting them aside as a reserve.	Carry forward of Profits
107. (1)	Subject to the rights of persons, if any, entitled to shares with special rights as to dividends, all dividends shall be declared and paid according to the amounts paid or credited as paid on the shares in respect whereof the dividend is paid, but if and so long as nothing is paid upon any of the shares in the Company, dividends may be declared and paid according to the amounts of the shares.	Division of profits

	(2)	No amount paid or credited as paid on a share in advance of calls shall be treated for the purposes of this Article as paid on the share.	Payments in advance
	(3)	All dividends shall be apportioned and paid proportionately to the amounts paid or credited as paid on the shares during any portion or portions of the period in respect of which the dividend is paid; but if any share is issued on terms providing that it shall rank for dividend as from a particular date such share shall rank for dividend accordingly.	Dividends to be apportioned
108.	(1)	The Board may deduct from any dividend payable to any member all sums of money, if any, presently payable by him to the Company on account of calls or otherwise in relation to the shares of the Company.	No member to receive dividend whilst indebted to the Company and Company's right to reimbursement therefrom
	(2)	The Board may retain dividends payable upon shares in respect of which any person is, under the Transmission Clause hereinbefore contained, entitled to become a member, until such person shall become a member in respect of such shares.	Retention of dividends
109.	(1)	Any dividend, interest or other monies payable in cash in respect of shares may be paid by electronic mode or by cheque or warrant sent through the post directed to the registered address of the holder or, in the case of joint holders, to the registered address of that one of the joint holders who is first named on the register of members, or to such person and to such address as the holder or joint holders may in writing direct.	Dividend how remitted
	(2)	Every such cheque or warrant shall be made payable to the order of the person to whom it is sent.	Instrument of Payment
	(3)	Payment in any way whatsoever shall be made at the risk of the person entitled to the money paid or to be paid. The Company will not be responsible for a payment which is lost or delayed. The Company will be deemed to having made a payment and received a good discharge for it if a payment using any of the foregoing permissible means is made.	Discharge to Company
110.		Any one of two or more joint holders of a share may give effective receipts for any dividends, bonuses or other monies payable in respect of such share.	Receipt of one holder sufficient
111.		No dividend shall bear interest against the Company.	No interest on dividends
112.		The waiver in whole or in part of any dividend on any share by any document shall be effective only if such document is signed by the member (or the person entitled to the share in consequence of the death or bankruptcy of the holder) and delivered to the Company and if or to the extent that the same is accepted as such or acted upon by the Board.	Waiver of dividends
<b>UNPAID OR UNCLAIMED DIVIDEND</b>			
113.	(1)	Where the Company has declared a dividend but which has not been paid or claimed within thirty (30) days from the date of declaration, the Company shall, within seven (7) days from the date of expiry of the said period of thirty (30) days, transfer the total amount of dividend which remains unpaid or unclaimed, to a special account to be opened by the Company in that behalf in any scheduled bank subject to the applicable provisions of the Act and the Rules made thereunder.	Transfer of unclaimed dividend
	(2)	Any money transferred to the unpaid dividend account of the Company which remains unpaid or unclaimed for a period of seven (7) years from the date of such transfer, shall be transferred by the Company to the Investor Education and Protection Fund established under section 125 of the Act. Any person claiming to be entitled to an amount may apply to the authority constituted by the Central Government for the payment of the money claimed.	Transfer to IEPF Account
	(3)	No unclaimed or unpaid dividend shall be forfeited by the Board until the claim becomes barred by Applicable Laws.	Forfeiture of unclaimed dividend
<b>Accounts</b>			
114.	(1)	The books of account and books and papers of the Company, or any of them, shall be open to the inspection of directors in accordance with the applicable provisions of the Act and the Rules.	Inspection by Directors
	(2)	No member (not being a director) shall have any right of inspecting any books of account or books and papers or document of the Company except as conferred by Applicable Laws or authorized by the Board.	Restriction on inspection by members
<b>Winding up</b>			
115.		Subject to the applicable provisions of the Act and the Rules made thereunder –	Winding up of Company

	(a)	If the Company shall be wound up, the liquidator may, with the sanction of a special resolution of the Company and any other sanction required by the Act, divide amongst the members, in specie or kind, the whole or any part of the assets of the Company, whether they shall consist of property of the same kind or not.	
	(b)	For the purpose aforesaid, the liquidator may set such value as he deems fair upon any property to be divided as aforesaid and may determine how such division shall be carried out as between the members or different classes of members.	
	(c)	The liquidator may, with the like sanction, vest the whole or any part of such assets in trustees upon such trusts for the benefit of the contributories if he considers necessary, but so that no member shall be compelled to accept any shares or other securities whereon there is any liability.	
<b>Indemnity and Insurance</b>			
116.	(a)	Subject to the provisions of the Act, every director, managing director, whole-time director, manager, company secretary and other officer of the Company shall be indemnified by the Company out of the funds of the Company, to pay all costs, losses and expenses (including travelling expense) which such director, manager, company secretary and officer may incur or become liable for by reason of any contract entered into or act or deed done by him in his capacity as such director, manager, company secretary or officer or in any way in the discharge of his duties in such capacity including expenses.	Directors and officers right to indemnity
	(b)	Subject as aforesaid, every director, managing director, manager, company secretary or other officer of the Company shall be indemnified against any liability incurred by him in defending any proceedings, whether civil or criminal in which judgement is given in his favour or in which he is acquitted or discharged or in connection with any application under applicable provisions of the Act in which relief is given to him by the Court.	
	(c)	The Company may take and maintain any insurance as the Board may think fit on behalf of its present and/or former directors and key managerial personnel for indemnifying all or any of them against any liability for any acts in relation to the Company for which they may be liable but have acted honestly and reasonably.	Insurance
<b>General Power</b>			
117.		Wherever in the Act, it has been provided that the Company shall have any right, privilege or authority or that the Company could carry out any transaction only if the Company is so authorized by its Articles, then and in that case this Article authorizes and empowers the Company to have such rights, privileges or authorities and to carry out such transactions as have been permitted by the Act, without there being any specific Article in that behalf herein provided.	General power

**ARTICLES OF ASSOCIATION\*\*  
OF  
ROLEX RINGS LIMITED  
(Part B)**

**PRELIMINARY**

**1. Application of Table “A”**

Subject as hereinafter provided and in so far as these presents do not modify or exclude them the regulations contained in Table ‘A’ in the First Schedule to the Companies Act, 2013 shall apply to the Company in so far as they are applicable to a Public Limited Company. Further, this Part B will cease to operate and be effective from date of listing of Securities of the Company on one or more Stock Exchanges of India. Till the time of listing and trading of the Securities of the Company on a recognised stock exchange in India, Part A and Part B shall, unless the context otherwise requires, co-exist with each other. Notwithstanding anything contained herein, in the event of any conflict between the provisions of Part A and Part B of these Articles, the provisions of Part B of these Articles shall prevail.

**2. Headings**

The headings hereto shall not affect the construction hereof.

**3. Definitions**

<b>Affiliate</b>	<b>Affiliate</b> of any specified Person means any other Person directly or indirectly controlling or controlled by or under direct or indirect common control with such specified Person, and any investment funds managed or advised by such specified Person, provided that the Company shall not be considered as the Affiliate of any Shareholder. For the purposes of this definition, <b>control</b> when used with respect to any Person means the power to direct the management and policies of such Person directly or indirectly, whether through the ownership of voting securities, by contract or otherwise; and the terms <b>controlling</b> and <b>controlled</b> shall be construed accordingly;
<b>Articles</b>	mean these articles of association of the Company in force from time to time;
<b>Assets</b>	has the meaning given to it in the Investment Agreement;
<b>Board</b>	means the board of directors of the Company for the time being;
<b>Business</b>	means manufacturing, exporting, dealing, or acting as agents, hirers, repairers, cleaners of forgings, forged products, castings, metal forming, treatment of forgings and castings, machining and metal working of forgings and castings and lines allied to the same. It also includes the business of electricity generation by installing wind mills, hydro-electric generators, thermal power stations, gas turbines, diesel generating sets and any other mode of generation of electricity for captive consumption or for sale to other parties
<b>Business Day</b>	means a day (other than a Saturday or Sunday) on which banks are generally open in India and Mauritius for normal business
<b>Chairman</b>	means the Chairman of the Board for the time being of the Company;
<b>Company</b>	means Rolex Rings Limited
<b>Companies Act</b>	means the Companies Act, 2013 of India as amended from time to time;
<b>Company Secretary</b>	means the company secretary of the Company;



<b>Director</b>	means a director of the Company for the time being
<b>Disclosed</b>	means disclosed in writing by the Warrantors to the Investor or their authorised representatives in a disclosure letter (the <b>Disclosure Letter</b> ) dated on or about the date of the Investment Agreement, provided that a matter disclosed in the Disclosure Letter shall only be treated as being “ <b>Disclosed</b> ” in relation to any Warranty which disclosure has been made in relation to that specific Warranty
<b>Dispute</b>	has the meaning given to it in Article 84
<b>Disputing Party</b>	has the meaning given to it in Article 84
<b>EBITDA</b>	means earnings before interest, taxes, depreciation and amortisation as calculated in accordance with the Indian GAAP and shall be calculated in accordance with the principles set out in Schedule 10 to the Investment Agreement
<b>Encumbrance</b>	has the meaning given to it in the Investment Agreement;
<b>ESOP</b>	means the Employee Stock Option scheme as per provision of the Companies Act, read with all applicable Rules/ Regulations and as defined in the scheme of ESOP adopted by the Company
<b>Exit Difference</b>	has the meaning given to it in Article 51
<b>Further Subscription Option</b>	has the meaning given to it in Article 19
<b>Further Subscription Option Notice</b>	has the meaning given to it in Article 19
<b>Further Subscription Option Shares</b>	has the meaning given to it in Article 19
<b>Indemnity</b>	has the meaning given to it in Article 116
<b>Indemnity Claim</b>	has the meaning given to it in Article 116
<b>Indemnity Threshold</b>	has the meaning given to it in Article 116
<b>India</b>	means the Republic of India
<b>Insolvency Proceedings</b>	has the meaning given to it in the Investment Agreement;
<b>Investor</b>	Rivendell PE LLC (formerly NSR-PE Mauritius LLC)
<b>Investor Acceptance Letter</b>	shall have the meaning given to it in Article 26

<b>Investment Agreement</b>	means Investment agreement dated 22 September 2007 entered into between the Company, Rivendell PE LLC (formerly NSR-PE Mauritius LLC), a company established under the laws of Mauritius and Promoters, as amended from time to time
<b>Investor's Affiliate</b>	means any Affiliate of the Investor;
<b>Investor Directors</b>	has the meaning given to it in Article 35
<b>Investor Shares</b>	has the meaning given to it in the Investment Agreement;
<b>Investor Subscription Shares</b>	means the First Investor Subscription Shares and the Second Subscription Shares, i.e., 2,850 (two thousand eight hundred fifty only) Preference Shares, allotted to the Investor
<b>IPO or Initial Public Offer</b>	means the first public offering of Shares and listing of Shares on a Recognised Stock Exchange pursuant to which the Shares are listed and which satisfies each of the following conditions (i) the Shares are listed or quoted on a Recognized Stock Exchange, (ii) the initial public offering is consummated no later than March 31, 2022 or such other date as may be agreed between the shareholders, (iii) at least 10% (on a fully diluted basis) of the issued and outstanding Shares or the minimum number of shares mandatory under the listing requirements (whichever is more) are sold /issued to the public in the initial public offering, (iv) the initial public offering is managed by a reputable investment banking firm of high standing in the market in which such shares are to be offered, who is acceptable to the Investor, and (v) the initial public offering complies with all applicable legal, regulatory and listing requirements;
<b>IPO Investment Bank</b>	has the meaning given to it in Article 48
<b>IRR</b>	means internal rate of return;
<b>Licence</b>	has the meaning given to it in the Investment Agreement;
<b>Objection Notice</b>	has the meaning given to in Articles
<b>Objection Period</b>	has the meaning given to it in Articles
<b>Offer for Sale</b>	has the meaning assigned to it in SEBI (Issue of Capital and Disclosure Requirement) Regulations, 2018;
<b>Party</b>	means each of the Investor, the Promoters and the Company including their respective successors and permitted assigns and any Person that has entered into a Deed of Accession and <b>Parties</b> means all of them;
<b>Permitted Pledge</b>	means any Encumbrance over Shares held by the Promoters or any Promoter Affiliate in accordance with the Shareholders Agreement to which the Investor has given its consent in advance in writing;
<b>Person</b>	means any person (including a natural person), firm, company, corporation, government, state or agency of a state or any association or partnership (whether or not having separate legal personality) or two or more of the foregoing;
<b>Preference Share</b>	means a convertible or non-convertible or redeemable or cumulative or non-cumulative preference share in the capital of the Company, and having the rights specified in the

	Shareholders Agreement and/or these Articles;
<b>Promoters</b>	means Mr. Manesh Madeka, Mr. Rupesh Madeka, Mr. Pinakin Madeka, Mr. Jiten Madeka, and Mr. Bhautik Madeka
<b>Promoter Affiliate</b>	means with respect to each Promoter, any other Person controlled by the Promoter provided that the Company shall not be considered as a Promoter Affiliate. For the purposes of this definition, control when used with respect to any Person means the Promoter owning, whether directly or indirectly, 50% or more of the voting rights of such Person or having the right to appoint the majority of the board of directors (or equivalent) of such Person or otherwise having control of the management of such Person and the terms controlling and controlled shall be construed accordingly. A Promoter Affiliate shall include Rolex Properties Private Limited, Madeka Properties Private Limited and Rolex Industries Private Limited and their respective Affiliates.
<b>Promoter Connected Person</b>	has the meaning given to it in the Investment Agreement;
<b>Recognised Stock Exchange</b>	means: the BSE Limited; or the National Stock Exchange of India Limited; or such other stock exchanges acceptable to the Investor;
<b>Reserved Investor's Matters</b>	means any of the matters specified in Article 33 with respect to the Company;
<b>Registrar of Companies</b>	shall have meaning as defined in the Companies Act, 2013
<b>Relative</b>	has the meaning given to it in Section 2(77) of the Companies Act, 2013
<b>Request</b>	has the meaning to it in Articles
<b>Shareholders</b>	means the Investor and the Promoters and such other person in whose name Shares are registered in the Company's register of members who becomes a party to the Shareholders Agreement in accordance with the terms of the Shareholders Agreement and a <b>Shareholder</b> means any of them;
<b>Shareholders' Agreement</b>	Means Shareholders' agreement dated 22 September 2007 entered into between the Company, Rivendell PE LLC (formerly NSR-PE Mauritius LLC), a company established under the laws of Mauritius and promoters of the Company as amended from time to time, as amended from time to time.
<b>Shareholding Percentage</b>	means, in relation to any Shareholder, the number of Shares for which that Shareholder is registered in the Company's register of members expressed as a percentage of the total issued Shares of the Company;
<b>Shares</b>	means issued shares in the capital of the Company;
<b>Subscription</b>	has the meaning given to it in the Investment Agreement;
<b>Subsidiary</b>	has the meaning given to it in the Companies Act.
<b>Taxation</b>	has the meaning given to it in the Investment Agreement;
<b>Warranties</b>	means the representations and warranties set forth in Schedule 4 to the Investment

	Agreement
<b>Warrantors</b>	means the Promoters and the Company.

## **PUBLIC COMPANY**

4. The Regulations contained in Table 'F' in the First Schedule to the Companies Act, 2013 shall not apply to the Company except in so far as they are repeated, contained or expressly made applicable in these Articles or by the said Act.

Provided that a company which is a subsidiary of a company, not being a private company, shall be deemed to be public company for the purposes of this Act even where such subsidiary company continues to be a private company in its articles

## **SHARE CAPITAL**

### **5. Division of Capital**

The Authorised Share Capital of the Company shall be as per clause V of the Memorandum of Association of the Company with rights to alter the same in whatever way as deemed fit by the Company.

### **6. General Authority**

Wherever in the Companies Act it has been provided that the Company shall have any right, privilege or authority or that Company cannot carry out any transaction unless the Company is so authorised by its Articles then in that case, Articles hereby authorise and empower the Company to have such rights, privilege or authority and to carry out such transaction as have been permitted by the Companies Act.

### **7. Issue of Preference Shares**

The Board may at any time, as it deem fit, subject provisions of the Companies Act, and Rules/Regulations framed thereunder, issue, allot, redeem etc. the preference shares whether redeemable, convertible, non-convertible, cumulative, non-cumulative or any other type of preference shares as may be permitted by the law for the time being in force.

### **8. Shares at the disposal of Directors**

Subject to provisions of Articles 23 to 31 of these Articles, the shares of the Company shall be under the control of the Directors who may allot or otherwise dispose of the same or any of them to such persons, in such proportions and on such terms and conditions and at par, at premium or at discount subject to the provisions of the Companies Act as they may from time to time think proper.

### **9. Calls**

The Directors may, from time to time, make calls upon the members in respect of any money unpaid on the shares in any manner, as they deem fit.

### **10. Power to issue shares at Discount**

With the previous authority of Company in General Meeting and the sanction of the National Company Law Tribunal and upon otherwise complying with the provisions of Section 79 of the Companies Act, 2013, it will be lawful for the Directors to issue at a discount, shares of a class already issued.

### **11. Buy back of Shares**

Subject to the provisions of Section 77A and any amendments made in the Companies Act,2013, the Company shall have the power to buy back its own shares, whether or not there is any consequent reduction of capital. If and to the extent permitted by law, the Company shall also have the power to re-issue the shares so bought back.

**12. [THIS ARTICLE HAS BEEN INTENTIONALLY LEFT BLANK.]**

**13. First named person deemed sole holder**

If any share stands in the names of two or more persons, the person first names in the Register of Members shall as regards voting at meetings, service of notice and all or any matters connected with the Company, except the transfer of shares and any other matters herein otherwise provided, be deemed to be sole holder thereof but joint holders of the shares shall be severally as well as jointly liable for the payment of all deposits, instalments and calls due in respect of such shares and for all incidents thereof according to the Company's regulations.

**14. Directors may allot shares for consideration other than cash**

The Board may issue and allot shares in the capital of the Company as payment or part payment for any property sold or transferred, goods or machinery supplied or for service rendered to the Company in or about the conduct of the Company's business and shares to be allotted may be issued as fully paid up shares and if so issued, shall be deemed to be fully paid up shares.

**15. Liability of Members**

Every member or his heirs, executors, administrators, assigns or other representatives shall pay to the company the portion of the capital represented by his share or shares which may for the time being remain due and unpaid thereon in such amounts, at such time or times and in such manner as the Board shall from time to time in accordance with the Company's regulations require the payment thereof and so long as any money remains due, owing and unpaid to the Company by any member on any account, such member shall not be entitled at the option of the Board, to exercise any rights or privileges.

**16. [THIS ARTICLE HAS BEEN INTENTIONALLY LEFT BLANK.]**

**17. Increases in Capital**

(b) Each of the Company and the Promoters agrees with the Investor that from the date of execution of the Shareholders Agreement, no Shares or other equity or equity-linked securities in the capital of the Company (including convertible bonds and convertible preference shares and Shares issued to Shareholders (other than the Investor) shall be issued to any Person on terms including the price, that are more favourable to that Person (the **Terms**) than the terms obtained by the Investor for the Investor Shares under the Articles, the Investment Agreement and the Shareholders Agreement, without the prior written consent of the Investor.

(c) Without prejudice to the Investor's rights with respect to Reserved Investor's Matters and in the Investment Agreement and subject to this Article 17, if any Shares or other equity or equity-linked securities (including convertible bonds and convertible preference shares) are to be offered to any Person(s) (other than the Investor or Affiliates of the Investor) for any reason whatsoever on Terms, each of the Company and the Promoters agrees with the Investor that the Investor's terms of investment for the Investor Shares (including without limitation the terms and conditions of the Investor Shares and the provisions of the Shareholders Agreement) shall, at the sole option of the Investor, be adjusted with retrospective effect so that the terms obtained by the Investor for the Investor Shares are, in each of the above respects but without limitation, at least as favourable as the Terms offered to such Person. Each of the Promoters and the Company shall do all acts necessary to give effect to the provisions of this Article under the regulatory framework in India.

**18.** All other terms and conditions agreed between the parties under the Shareholders' Agreement including amendments will be deemed to have included in the Part B of the Articles and in case of conflict between Part B of Articles and Shareholders' Agreement, the provisions of Shareholders Agreement will prevail.

**19. Right to Further Subscription Option**

(a) In the event the Investor's shareholding in the Company falls or is contemplated to fall below 26.88%, whether as a result of the conversion of the Investor Subscription Shares as

contemplated in Article 18 or otherwise, the Investor and any Investor Affiliate that holds Shares shall have an option (the **Further Subscription Option**), in their sole and absolute discretion, to subscribe, or to have another Investor's Affiliate subscribe, for new Shares, each at the price at which the Investor Subscription Shares have or are proposed to be converted, up to a maximum aggregate, when all subscriptions by the Investor and any Investor's Affiliate under the Further Subscription Option and the conversion or proposed conversion of the Investor Subscription Shares are taken together, of 26.88% of the fully diluted share capital of the Company.

- (b) The Further Subscription Option shall be exercisable by the Investor, or any relevant Affiliate of the Investor, by stating in the notice to be provided to the Company (the **Further Subscription Option Notice**):
  - (i) that the Investor or relevant Affiliate of the Investor will exercise the Further Subscription Option;
  - (ii) the number of Shares in respect of which the Investor or relevant Affiliate of the Investor wishes to exercise the Further Subscription Option (the **Further Subscription Option Shares**); and
  - (iii) the identity of the subscribing entity.
- (c) If the Investor provides notice to exercise the Further Subscription Option as referred to in Article 19(b), the subscription pursuant to the Further Subscription Option shall be completed in the manner set out in Article 19(d) below.
- (d)
  - (i) 75% of the Further Subscription Option Shares shall be subscribed by the Investor at a price per share equal to the effective price per share, set out in the table in Clause 2.2(a)(i) or (ii) of the Investment Agreement as the case may be, which corresponds to the relevant number of converted Shares in the relevant table;
  - (ii) 25% of the Further Subscription Option Shares shall be subscribed by the Investor or any of its nominee at a price per share, which at the option of the Investor shall be either of (A) the fair market value of the Further Subscription Option Shares as may be calculated by an independent valuer to be appointed by the Investor; or (B) which is up to 20% less than the pre IPO price as may be determined by the Company's investment banker.
  - (iii) The timing of the subscription of the Further Subscription Option Shares shall be at the discretion of the Investor and may be set out by the Investor in the Further Subscription Option Notice.

## 20. Source and use of funds

The Company undertakes with the Investor that it will utilise the proceeds of the subscription by the Investor for the Investor Shares (including, for the avoidance of doubt, proceeds arising from any acquisition by the Investor under the Investment Agreement solely for its capital expenditure and working capital requirements in accordance with the Annual Business Plan or such other purpose as is jointly approved by the Promoters and the Investor, the actual disbursement of which shall be subject to unanimous Board approval.

## TRANSFER AND TRANSMISSION OF SHARES

### 21. General restriction

Except as hereinafter provided no share shall be transferred to a person who is not a member of Company as on date of adoption of these Articles.

### 22. Restrictions on transfer

- (a) No Shareholder shall, directly or indirectly:
  - (i) transfer its Shares, or otherwise sell, create or permit to subsist any Encumbrance over or otherwise dispose of all or part of its interest in its Shares; or

- (ii) enter into any agreement in respect of any votes attaching to its Shares,

(any of such events a **Dilution**) except in accordance with these Articles and the provisions of the Shareholders Agreement. Any direct or indirect transfer or sale of Shares or the granting of any Encumbrance over Shares in breach of the Shareholders Agreement shall be null and void *ab initio* subject to applicable laws.

- (b) It shall be a condition of any transfer of Shares by any Shareholder that the transferee enters into a Deed of Accession in the format as laid out in Schedule 3 to the Shareholders Agreement.

### **23. Non-disposal undertaking from the Promoters**

- (a) The Promoters agree that, for so long as the Investor and/or any Affiliate of the Investor holds any Share in the Company, there shall be no Dilution by any of the Promoters or any Promoter Affiliate that owns Shares, except for any Dilution:
  - 1. in accordance with Articles 22(a) & 22(b);
  - 2. in relation to an IPO permitted under the Shareholders Agreement;
  - 3. that constitutes a Permitted Pledge; or
  - 4. in the case of Dilution by way of the creation of any Encumbrance over all or part of a Promoter or Promoter Affiliate's interest in its Shares, only for the purpose of raising capital for the Company, subject to and with the prior written approval of the Investor.
- (b) The Parties further agree that, notwithstanding any provisions of the Shareholders Agreement, any transfer of shares or Encumbrance of their Shares by the Promoters including for the sake of clarity any transfer under Article 22(a) & 22(b) by the Promoter will require the prior written approval of the Investor.

### **24. Transfers between Promoters**

- (a) The Parties acknowledge that the Promoters are obliged to hold at least 51% of the total issued share capital of the Company (the **Minimum Promoter Shareholding**) at all times.
- (b) Subject to the Article 23(b) above, the Promoters shall be entitled to undertake transfer of Shares between themselves and each Promoter shall be entitled to transfer up to 50% of his Shares to his spouse and children, provided that the Minimum Promoter Shareholding is maintained at all times.

### **25. Transfers By The Promoters To Promoter Connected Persons**

Subject to Articles 24(b) and 25, each Promoter shall be entitled to transfer its Shares to any of its Promoter Connected Persons provided that each such Party shall be jointly and severally liable with any such Promoter Connected Person for the performance by that Promoter Connected Person of its obligations under the Shareholders Agreement and in respect of any breach thereof by that Promoter Connected Person and in the case of any subsequent transfer of Shares by any Promoter Connected Person to any other Promoter Connected Person, the Promoter shall be jointly and severally liable for the performance by each Promoter Connected Person who holds Shares of its obligations under the Shareholders Agreement.

### **26. Investor's Rights of First Refusal**

- (a) Without prejudice to the restrictions on the Promoters as provided in Article 23, but subject to the provisions of Article 23(b), if any Promoter or any Promoter Affiliate that owns Shares or other Person (save and except the Investor) proposes to Transfer any of the Shares held by it (**Promoter Shares**) to a Third Party, then such Promoter shall serve a notice to the Investor in writing stipulating the terms and conditions of the offer made by the third party transferee to the transferor Promoter(s), which notice shall include (a) the identity of such proposed third party transferee, the price (including, where such price comprises a non-cash consideration, the transferor Promoter's certification of the cash value thereof), the number of Promoter Shares proposed to be transferred and the other terms and conditions on which it proposes to transfer

the Promoter Shares to such third party transferee; and (b) offer to transfer such Promoter Shares to the Investor, at the same price and on the same terms and conditions as offered by such third party transferee (**Promoter Notice**).

- (b) The Investor shall have the right, within a period of 30 days from the date of receipt of the Promoter Notice (**Offer Period**) to either (a) notify such Promoter of its intention to exercise its tag along rights under Article 27 in which event the provisions of Article 27 shall apply; or (b) accept such offer of the Promoter to purchase such of the Promoter Shares as are notified in the Promoter Notice (Investor Agreed Shares). In the event that the Investor chooses to accept such offer of the Promoter, it shall convey such acceptance to the Promoter by way of a written notice (the Investor Acceptance Letter) and the Parties shall take all steps to cause the transfer of the Investor Agreed Shares on the terms mentioned in the Promoter Notice and in accordance with the Investor Acceptance Letter within a period of 30 days following the date of receipt by the Promoter of the Investor Acceptance Letter. The Parties agree that time required for consents from governmental authorities or for compliance with any requirements of law shall be excluded in calculating the foregoing period of 30 days. The Company shall and the Promoter shall procure that the Company shall, make all requisite applications to obtain such consents in a timely manner for giving effect to the provisions of this Article 26.
- (c) In the event the Promoter does not receive any Investor Acceptance Letter in accordance with Article 27(a) or a Tag Along Notice in accordance with Article 27, the Promoter may transfer the Promoter Shares on terms no more favourable than those mentioned in the Promoter Notice to the transferee mentioned therein within 90 days of the expiry of the Offer Period. Provided however, that such transferee shall execute a Deed of Accession agreeing to abide by the terms and conditions of the Shareholders Agreement and the Articles of the Company. The time required for obtaining the requisite approvals from governmental authorities shall not be considered for the purposes of calculation of this period of ninety (90) days.
- (d) If the Promoter Shares are not sold within 90 days of the expiry of the Offer Period, the Investor's rights under this Article 26 shall again take effect with respect to any transfer of Shares held by the Promoter, and so on from time to time.
- (e) Notwithstanding the provisions of Article 26 (c) the Promoter shall be required to furnish to the Investor necessary documentation evidencing the completion of the sale of the Promoter Shares on terms no more favourable than those mentioned in the Promoter Notice to the transferee mentioned therein within 90 days of the expiry of the Offer Period.

## **27. Investor's Tag-Along Rights**

- (a) Without prejudice to Articles 223 and 04, each of the Promoters agrees with the Investor that before transferring or disposing of any of its Shares, whether directly or indirectly, to any Person (other than another Promoter), a Promoter or any Promoter Affiliate that owns Shares or other Person (save and except the Investor) shall provide a Promoter Notice as set out in Article 27(a) above to the Investor.
- (b) the relevant Promoter shall not be entitled to transfer the Promoter Shares to the third party transferee unless the relevant Promoter complies with, and procures that the third party transferee complies with, the following provisions:
  - (i) the Investor shall have the option, exercisable by notice in writing to the Seller (the **Tag Along Notice**) within 30 days of the date of receipt of the Promoter Notice, to require that the relevant Promoter includes in the sale to the third party transferee, as part of the total number of Promoter Shares, at the price and on the same terms and conditions as offered by the third party transferee to the relevant Promoter, such number of Shares (or a part thereof) which shall be equal to or less than the Promoter Shares multiplied by a fraction, the numerator of which is the number of Shares held by the Investor (which may include Shares owned by the Investor's Affiliates) and the denominator of which is the total number of Shares held by the Investor and the Promoters; and
  - (ii) if the Investor delivers a Promoter Notice, the relevant Promoter shall not be entitled



to complete the transfer of the Promoter Shares to the third party transferee unless the third party transferee also concurrently completes the purchase from the Investor (or any of their Affiliates, if relevant) of such number of Shares as were required to be included in the sale of the Promoter Shares to the third party transferee in accordance with subparagraph b(i).

- (iii) if the Investor does not deliver a Tag Along Notice within a period of 30 days from the receipt of the Promoter Notice, the Investor shall be deemed to have waived its tag along right with respect to the proposed sale by the Promoters to the third party transferee.

## **28. Share transfers by the Investor**

Notwithstanding any provision in these Articles (including the provisions of Article 23 above) to the contrary but subject to the provisions of the Companies Act, the Investor Shares shall be free from any lien and lock in and shall be freely transferable and tradable to any of its Affiliates or to any third party, provided that in case such transfer is to be completed before 31 March 2022, then such Affiliate or third party is not an entity (or member of a group) which is primarily engaged in the business of conducting any type of forging activity, without the prior written consent of the Promoters. The Company and the Promoters agree that in the event the Investor transfers any of the Investor Shares to any third party, the Investor shall have the right, solely at its option, to elect which rights (all or part) provided to the Investor by the Company and / or the Promoters under these Articles should also be assigned by the Investor to such third party, provided further there shall be no duplication or multiplicity of rights of the Investor and such third party or the obligations of the Company and/or the Promoters.

## **29. Approval of share transfers**

- (a) The Promoters jointly and severally undertake and covenant to the Investor that they shall exercise all rights and powers available to them to procure that the Directors (except the Investor Directors) on the Company's share transfer committee (or on the Board) shall approve all transfers of Shares that are in accordance with the terms of the Shareholders Agreement.
- (b) The Company undertakes, and the Promoters undertake and covenant jointly and severally, to the Investor, that they shall exercise all rights and powers available to them to procure that the Directors (except the Investor Directors) on the Board or any committee of the Board, shall not approve any transfer of voting securities of the Company to, and the Promoters further undertake that they shall not sell any voting securities of the Company held by them to, any Person whose ownership of such securities would cause a Person not a shareholder prior to such proposed transfer or sale to be treated as a United States shareholder, as defined in Section 951(b) of the United States Internal Revenue Code of 1986, with respect to the Company, without the prior approval of the Investor.

## **RESERVED MATTERS**

## **30. Reserved Investor's matters**

So long as the Investor holds Investor Subscription Shares or, post conversion, Shares equivalent to not less than 5% (five percent) of the total number of Shares of the Company, the Company shall, and each of the Shareholders shall, exercise all rights and powers available to it to procure that, from the date of the Shareholders Agreement until such time as the Shareholders Agreement is terminated in accordance with the terms thereof, none of the Reserved Investor's Matters shall occur with respect to the Company unless it has first been approved by the Investor in writing. Any matter relating to the Reserved Investor's Matters must be referred to the Board, and, subject to the provisions of the Shareholders Agreement, no Shareholder, Director, officer, committee, committee member, employee, agent or any of their respective delegates shall take any actions purporting to commit the Company in relation to such matters without the prior approval of at least one (1) Director nominated by the Investor. For the purpose of these Articles, Reserved Investor's Matters shall mean the matter provided in the Shareholders' Agreement:

## **DIRECTORS**

### **31. Number of Directors**

The number of the Directors shall not be less than two and more than 12 (twelve) including two Investor Directors, but excluding the Nominee Director and Alternate Director, if any.

### **32. Power to appoint Alternate Director**

Subject to Section 161 of the Companies Act, 2013, the Board of Directors of the company may appoint an Alternate Director to act for a Director during his absence for a period of not less than three months from the State in which the meetings of the Board are ordinarily held.

### **33. Power of Directors to appoint Additional Directors**

The Directors shall have power at any time and from time to time to appoint any other person as Director as an addition to the Board so that total number of Directors shall not at any time exceed the maximum number fixed as above and any person so appointed as an Additional Director shall retain his office only until the next Annual General Meeting but shall then be eligible for re-appointment.

### **34. Nominee Directors**

Subject to the provisions of the Companies Act and of these Articles, whenever the Directors enter into a contract with any Government, Central, State, or Local, any Bank/s or Financial Institution/s or any person/s (hereinafter referred to as "the Appointer") for borrowing any money or for providing any guarantee or security for any technical or financial collaboration or assistance or for entering into any other arrangement, whatsoever, the Directors shall have the power to agree that such appointer shall have the right to appoint or nominate by a notice in writing addressed to the Company one or more Directors on the Board for such period and upon such terms and conditions as may be mentioned in the agreement and that such Director may not be liable to retire by rotation nor be required to hold any qualification shares. The Directors of company may also agree that such Director or Directors may be removed from time to time by the appointer and the appointer may appoint another or others in his or their place and also fill in any vacancy, which may occur as a result of any such Director or Directors ceasing to hold that office for any reason whatsoever.

Notwithstanding anything contained in Articles 31 to 33, but subject to Article 53 and subject to provisions of Shareholders' Agreement, and in addition to powers conferred upon the Board to appoint Directors under Section 152, 161 and 162 of the Companies Act, 2013 the Board shall have, pursuant to Section 152 of the Companies Act, 2013 powers to appoint any Director as Permanent Directors, who shall not be liable to retire by rotation. The person so appointed, pursuant to these Articles, shall be eligible to act as director until he/she resigns, died, becomes disqualified to be a director of the company or otherwise vacates his office pursuant to the provisions of the Companies Act.

### **35. Nomination of Directors**

The following provisions shall apply for so long as the Shareholders Agreement is in force in accordance with its terms:

- (a) on and from the First Completion Date, the Investor shall be entitled to nominate such number of Directors (the **Investor Directors**) as is proportionate to the Investor's aggregate Shareholding Percentage subject to a minimum of two (2) Investor Directors. The Investor shall have the right to appoint Investor Directors so long as the Investor holds Investor Subscription Shares or, post conversion, the Investor's shareholding in the Company is equal to or more than 5% (five percent) of the total number of Shares of the Company;
- (b) it is agreed that the Investor may replace any Investor Director at any time;
- (c) each Director shall be entitled to nominate, by written notice to the Company Secretary/Board, a person who will be appointed by the Board to act as that Director's alternate at any meeting of the Board which that Director will not attend in person and the Board shall appoint such

person as the relevant Director's alternate. The Board shall, on written notice from a Director to the Company Secretary/Board, terminate the appointment of that Director's alternate and nominate a replacement and re-appoint an alternate in the event that the alternate appointment lapses under the provisions of applicable laws;

- (d) when permitted by applicable laws if any Director requests, he may participate in any meeting of the Board by means of a telephone or video conference, whether or not the alternate nominated by that Director is physically attending that meeting;
- (e) each of the Shareholders and the Company shall exercise all rights and powers available to it, including the exercise of votes at Board meetings and general meetings of the Company, to procure that effect is given to any nominations made by the Investor under this Article;
- (f) if retirement by rotation is applicable and subject to the provisions of the Companies Act, the Directors nominated by the Investor shall not be required to retire by rotation and all other Directors shall constitute the number of Directors required to retire by rotation; and
- (g) any change and/ or appointment of independent Directors will be subject to the approval of the Investor.

### **36. Chairman and Managing Director**

The Parties agree that Mr. Manesh Madeka shall be designated as the Chairman and Managing Director of the Company and the Promoters shall be entitled to appoint the Chairman of the Board as well as the Managing Director of the Company though any change in the Chairman or Managing Director shall require the prior written consent of the Investor. The Chairman shall not have a second or casting vote in the event of an equality of votes at Board meetings or general meetings of the Company.

### **37. Board Meetings**

Each Shareholder shall exercise all rights and powers available to it to ensure that the Company and the Directors adopt the following rules in relation to Board meetings:

- (a) Board meetings shall be held at least once in every three (3) months and at least four (4) times every year;
- (b) at least 7 calendar days' written notice shall be given to each Director of each meeting setting out the agenda for the meeting in reasonable detail and attaching the relevant papers to be discussed at the meeting and all available data and information relating to matters to be discussed at the meeting except as otherwise agreed in writing by all of the Directors;
- (c) unless otherwise agreed by the Investor in advance:
  - (i) in writing; or
  - (ii) by telephone, fax, e-mail or other electronic communication, such agreement to be confirmed in writing as soon as is reasonably practicable,

and after the Investor having been provided with the agenda for the relevant meeting, without prejudice to the Investor's rights with respect to Reserved Investor's Matters, the quorum for a meeting of the Board, duly convened and held, shall be one third of the total number of Directors or two (2) Directors, whichever shall be higher. PROVIDED however that no quorum as aforesaid shall be validly constituted, and no business at any meeting of the Board shall be transacted, unless at least 1 (one) Director nominated by the Investor and at least 1 (one) Director nominated by the Promoters is present at the commencement of such meeting and throughout its proceedings. In the event that a higher number of Directors is required to constitute a quorum under the Companies Act, then the quorum for Board meetings shall be the number and composition of Directors prescribed in the preceding sentence of this Article 37(c) plus such additional number of Directors as is required to form a quorum under the Companies Act. Without prejudice to the Investor's rights with respect to Reserved Investor's Matters, if no quorum is present by the appointed time for any meeting of the Board, the meeting shall

stand adjourned to the same day in the next week at the same time and place and the quorum at such adjourned meeting shall be that prescribed above. If at the adjourned meeting no quorum is present by the appointed time for the meeting of the Board, the meeting shall once again stand adjourned to the same day in the next week at the same time and place and the quorum at such adjourned meeting shall, notwithstanding the above, be that prescribed under the Companies Act provided that:

- (i) written notice of the adjournment was given to each Director at his usual address for service of notices of Board meetings not less than 3 calendar days before the date of the adjourned meeting; and
  - (ii) no agenda items may be considered at the adjourned meeting which were not specifically set out on the agenda for the meeting which was adjourned.
- (d) if the Investor has agreed under Article 37 (c) above that the quorum for a meeting shall not include one (1) of the Directors nominated by the Investor then:
- (i) no matter shall be tabled, discussed or resolved at that meeting unless such matter was specifically set out and described in the agenda provided to the Investor prior to its agreement under subparagraph (c) above and, notwithstanding any provision in that agenda for the tabling of, discussion regarding or resolution on “other business”, “other matters with the permission of the Chairman” or similar, no such other matters shall be tabled, discussed or resolved at that meeting; and
  - (ii) such meeting shall be deemed inquorate if any matter is tabled, discussed or resolved in contravention of subparagraph (i) above;
- (e) each Director may cast one (1) vote;
- (f) subject to Article 30 and applicable provisions of the Companies Act, decisions of the Board shall be made on the basis of a majority vote;
- (g) when permitted under applicable laws, any Director may participate in and vote at a meeting of the Board by means of a telephone, video conferencing or similar communications equipment which allows all persons participating in the meeting to hear each other and record the deliberations. Where any Director participates in a meeting of the Board by any of the means described in the preceding sentence of this Article 37(g), the Company shall ensure that that Director is provided with a copy of all documents referred to during such Board meeting before the Board meeting commences;
- (h) subject to Article 30, a circular resolution in writing, executed by or on behalf of a majority of the Directors, which majority of the Directors shall always include 1 (one) Director nominated by the Investor, shall constitute a valid decision of the Board provided that a draft of such resolution was sent to all of the Directors at their usual address together with a copy of all supporting papers;
- (i) the Chairman shall procure that the minutes of each meeting of the Board are prepared and circulated to each Board member within 15 calendar days of the meeting. Members of the Board shall make any comments on the minutes of the meeting within 7 calendar days of receipt of the minutes. If no comments are made within the time limit set out in this Article, the minutes shall be deemed to be accepted. The minutes shall be signed at the commencement of the next meeting of the Board;
- (j) Directors are not entitled to be paid for acting as Directors, other than as prescribed by the Companies Act or as agreed to between a particular Director and the Company in writing, but they are entitled to be paid by the Company for all reasonable travel, hotel and other expenses properly incurred by them in attending meetings and discharging their duties.

**38. Board committees and nomination on future joint ventures or subsidiaries**

- (a) The Board shall appoint a representative of the Investor on any committee of the Board or any other management committee of the Company, unless otherwise confirmed to the Board by the Investor in advance in writing. For the avoidance of doubt, any decision taken at any such committee that relates to a Reserved Investor's Matter shall not be valid unless it is approved by the Investor.
- (b) The Parties agree that the Investor shall have the right to nominate a representative on the board of directors of any company, whether existing on the date hereof, or incorporated in the future, which becomes a joint venture or subsidiary of the Company in accordance with the provisions of the Companies Act. The Investor shall only have the right to nominate a representative on the board of directors of any of the Company's joint ventures, if the Company has a right to appoint more than one (1) director on the board of that joint venture.

**39. [THIS ARTICLE HAS BEEN INTENTIONALLY LEFT BLANK.]**

**40. Related party transactions**

Without prejudice to the Investor's rights with respect to Reserved Investor's Matters, all related party transactions, being transactions between the Company and any Shareholder or Affiliate of any Shareholder or any Promoter Connected Person, including but not limited to investments in and loans to such Persons and the formation of subsidiaries and/or Affiliates of the Company, shall be conducted on an arms-length basis in accordance with a set of Board policies and procedures as set out in Schedule 5 to the Shareholders Agreement.

**41. Limitation of liability, Director and officer insurance**

None of the Investor nor any of its respective directors, officers, managers, employees, agents or representatives shall be held liable by the Company, the Promoters or any third party for, or on account of any act or any failure to act by any such person while serving as Director of the Company unless such act or failure to act shall be in bad faith and in wilful disregard of the duties imposed upon such person by applicable law, the Shareholders Agreement, the Company's Memorandum of Association and the Articles. The Promoters shall cause the Company to, and the Company shall, maintain appropriate insurance coverage and provide for standard indemnification provisions in the amended Articles for the Investor Directors in relation to the discharge of their respective duties.

**42. Senior management of the Company**

- (a) The Promoters and the Investor agree that the Promoters shall submit a senior management recruitment and retention policy including employment contracts and employee incentive compensation program, including the employment stock option scheme or plan as contemplated under the Investment Agreement, to the Investor for its approval within a reasonable period after the date of the Shareholders Agreement.
- (b) The appointment or removal of any of the senior management personnel of the Company shall be subject to prior agreement between the Promoters and the Investor.
- (c) The Parties further agree that the Promoters shall at all times, until the termination of the Shareholders Agreement in terms of Clause 13.2 of the Shareholders Agreement, retain management control of the Company.

**INFORMATION, ACCOUNTING RECORDS, AUDIT, ACCESS AND DIVIDEND POLICY**

**43. Information**

The Company shall, subject to any third party restrictions placed on its right to disclose information, provide each Shareholder with the following information relating to the Company:

- (a) quarterly unaudited financial statements relating to the Company prepared in accordance with

Indian GAAP, within 30 calendar days of the end of each quarter;

- (b) audited annual financial statements of Company within 90 calendar days after the end of each financial year of the Company;
- (c) monthly MIS report in such form as the Investor reasonably require within 15 calendar days of the end of each month; and
- (d) such further information relating to the business, affairs or financial position of the Company, including but not limited to material litigation, books and accounts and other records.

The Company shall also procure that the Investor shall have access to and the right to inspect all information and material, financial or otherwise, provided to any member of the Board, books of accounts and other business records, and the right to advise or consult with, management of the Company as it may from time to time require.

**44. Accounting Records**

The Company shall maintain accurate and complete accounting and other financial records and procure that those accounting records are available for inspection by each Shareholder or its respective authorised representatives during normal business hours. The Company shall ensure that there is no financial irregularity in the Company.

**45. Auditor**

- (a) The Parties agree that the Investor shall have the right to appoint its own independent special auditor for the purpose of undertaking a review of the accounts of the Company and the costs in relation to the conduct of these special audits shall be borne by the Investor. The Company shall provide, and the Promoters undertake to ensure that the Company provides such special auditor with all requisite information and support from time to time.
- (b) The Company shall appoint the statutory auditors of the Company who shall be one of the Big 4 international firms and the internal auditors of the Company only with the mutual consent of the Promoters and the Investor.

**46. Accounting Principles**

The financial statements of the Company shall be prepared in accordance with applicable law.

**47. INTENTIONALLY LEFT BLANK**

**INITIAL PUBLIC OFFER BY COMPANY PURSUANT TO SHAREHOLDERS' AGREEMENT**

**48. Process for IPO**

- (a) Each of the Promoters and the Company undertakes to the Investor that:
  - (i) the Company will complete an IPO on or prior to 31 March 2022 or such other date as may be agreed between the shareholders; and
  - (ii) it will do all acts, deeds and things that are commercially reasonable to ensure a successful IPO.
- (b) Subject to Articles 48(a) and (b), the terms, timing and pricing for the IPO shall be subject to the approval of the Board.
- (c) The IPO will be based on the advice of a reputable and internationally renowned investment bank and shall be structured so as to maximise value to the Shareholders.
- (d) The Company has the right, with the prior written approval of the Promoters and the Investor, at the cost of the Company, to engage a reputable and internationally renowned investment bank

(the **IPO Investment Bank**) to advise on the IPO prospects of the Company. The Promoters agree with the Investor that, if the IPO Investment Bank advises that the timing and structure for any proposed IPO are favourable, the Promoters shall if so directed by the Investor in writing procure that the Company shall implement the proposed IPO in accordance with the recommendations of the IPO Investment Bank. In particular, but without limitation, the Promoters and the Company agree to provide all necessary information and access to records and materials of the Company to the IPO Investment Bank and to permit the IPO Investment Bank to carry out all necessary tasks to enable it to agree on an appropriate underwriting price.

#### **49. Method of IPO**

The Promoters and the Investor have agreed as follows with respect to the IPO:

- (a) For the purpose of an IPO, to the extent permissible in law the Investor's Shares shall not be considered as promoter shares and shall not be subjected to a lock-in or other restriction on transfer as applicable to promoter's contribution under the guidelines of Securities Exchange Board of India or any other statutory or regulatory authority as applicable from time to time.
- (b) The Company and Promoters agree and acknowledge that if such IPO is made in India, the Company is required to offer a minimum number of Shares, as required under applicable Indian law, existing from time to time, and in order to comply with such requirements, the Company shall be empowered to make its IPO in any manner or a combination thereof, including (i) issuance of new Shares; (ii) issuance of fresh Shares and the divestiture of all or a part of the shareholdings of the Promoters; or (iii) solely through the divestment of all or a part of the shareholdings of the Promoters. Without prejudice to the provisions of Article 51 below, the Investor shall be entitled (without being obliged) to offer all or some of its Shares in any public offering of the Company on the same terms as the primary Shares offered to the public by the Company. The Investor shall consider the recommendations of the IPO Investment Bank in this regard.
- (c) Unless prohibited by applicable law, the Company shall bear all costs of such IPO of its shares and of any disinvestments of its shares by public offer by sale by the Investor, including without limitation all registration, filing and qualification fees and printers, legal and accounting fees and disbursements. The Company undertakes that it shall take all such actions as may be possible to enable it to bear such expenses in accordance with applicable law.
- (d) If an IPO is to be made and if the minimum paid-up Share capital required at the relevant time for the purpose of listing the Company's Shares is more than the paid up Share capital of the Company (inclusive of any additional Shares to be issued through the IPO), then the Company shall, subject to the Investor's consent, and unless prohibited by applicable law, issue such bonus Shares as are required to meet such listing preconditions.
- (e) The Promoters and the Company will take all such steps, and extend all such co-operation to each other and IPO Investment Bank, underwriters and others as may be required for the purpose of expeditiously making and completing the said IPO.
- (f) Without prejudice to the Investor's rights under the Shareholders Agreement, the Investor is to be consulted on all matters relating to the IPO, including the timing of, mode of, market conditions, of the IPO.

#### **50. Consequences of failure**

If, at any time after the Deadline Date, the Shares are not listed pursuant to an IPO then, the Investor shall have the following options:

##### **(a) Offer for Sale**

Without prejudice to the other rights of the Investor, and notwithstanding the reference to mutual appointment of an investment banker, on any Offer for Sale, the Investor shall have the right, subject to applicable law, to appoint an investment banker of its choice, on behalf of and at the

cost of the Company and to proceed to list the Investor Shares through an Offer for Sale of upto all the Shares held by it and the Company and the Promoters shall actively support such Offer for Sale and for this purpose, take all such actions as the Investor may request. For this purpose, the Board shall appoint a lead manager of its choice, who shall determine the price at which the Shares are to be offered in the Offer for Sale. On such determination, if the Investor desires to make the Offer for Sale, then the Promoters shall either:

- (i) offer to purchase all the Investor Shares as may be specified by the Investor at the price determined by the lead manager and, if the Investor accepts such offer, the Promoters shall thereupon pay the purchase price for such Shares within 30 calendar days and such sale shall, subject to Articles 22 to 26 above, be completed within 30 calendar days of such payment; or
- (ii) Cooperate with the Investor and the Promoters shall (if required) offer such additional Shares together with the Investor in such Offer for Sale as required by law such that the minimum public shareholding required pursuant to the then applicable SEBI and then applicable law or regulations of the equity share capital of the Company is achieved post-issue.

### **ALTERNATIVE EXIT MECHANISM**

#### **51. Exit Mechanism and appointment of Investment Bank**

- (a) On the occurrence of an Event of Default as set out in Shareholders Agreement, the Investor shall have the right at its sole discretion and at any time after such date exercisable on written notice to the Promoters and the Company (an **Exit Notice**) to sell all or some of the Shares held by it and its Affiliates to the Promoters and the Company and the Promoters and Company shall purchase such Shares from the Investor and its Affiliates in accordance with this Article at a price that is equal to the Exit Amount, the Exit Amount being the higher of:
  - (i) fair market value of the Shares held by the Investor (on a fully diluted basis taking into account the Shares issued pursuant to Clauses 2.2 (on conversion), 2.3 and 2.4 of the Investment Agreement) as at the day of the Exit Notice, as determined by an independent investment bank appointed in accordance with this subparagraph, such fair market value:
    - (A) to include the value of the business of the Company as a whole, including the value of any business conducted with third parties including, but not limited to, joint ventures and subsidiaries of the Company; and
    - (B) not to be discounted in any way as a consequence of the fact that the Shares are not listed on a Recognised Stock Exchange; and
  - (ii) an amount equivalent to the total amount invested by the Investor plus 30 per cent IRR per annum on a cumulative basis on such amount.
- (b) For the purposes of subparagraph (a) above, the independent investment bank shall be appointed as follows:
  - (i) (A) the Promoters and (B) the Investor shall agree on a list of the five (5) leading and reputed investment banks operating in India. If there is a failure to reach an agreement on the identities of such investment banks within five (5) Business Days of the Exit Notice, the Investor shall in its absolute discretion select an investment bank and the provisions in subparagraph (b)(ii) and (b)(iii) shall not apply;
  - (ii) each of (A) the Promoters and (B) the Investor shall nominate three (3) of the banks from the list of leading investment banks (each, an **Acceptable Investment Bank**); and
  - (iii) the Acceptable Investment Bank that is nominated by both the Promoters and the Investor shall be appointed for the purposes of this subparagraph. If more than one Acceptable Investment Bank is nominated by both the Promoters and the Investor then the Investor shall in its absolute discretion select an Investment Bank from the



Acceptable Investment Banks.

- (c) Unless otherwise agreed in advance in writing by the Investor, completion of the sale and purchase of the Shares under Article 51(a) shall take place on the date that is 30 calendar days after the later of the date of the Exit Notice or the date of determination of the fair market value. The Promoters or the Company, as applicable, shall be entitled to designate any other Person to take delivery of the Shares at such completion, provided that the identity of that Person has been disclosed to the Investor at least 15 calendar days before the date of such completion.
- (d) Without prejudice to the continuing obligations of the Promoters and the Company under Article 51(a) and 51(c) the Investor shall have the right at any time before the expiry of such 30 day period (or later period in the event the completion of the sale and purchase of the Shares under Article 51(a) has not taken place within such 30 day period) to serve written notice on the Promoters indicating that one or more third parties is interested in purchasing all of the Shares of the Investor and some or all of the Shares held by the Promoters and/or the Promoter Affiliates and:
  - (i) The Promoters and the Company shall provide all necessary support, including the sharing of Confidential Information, to allow a due diligence exercise to be conducted and to facilitate the evaluation of the sale of those Shares to such third parties;
  - (ii) if an offer is made by a third party to the Investor to purchase Shares that includes the purchase of some or all of the Shares held by the Promoters and/or the Promoters' Affiliates and such offer is accepted by the Promoters, the Promoters shall, and shall procure that the Promoters' Affiliates shall, provide such additional Shares from their holdings that are required to complete the sale to the third parties at the same price and on the same terms as are agreed by the Investor; and
  - (iii) the Promoters shall, and shall procure that each of the Promoters' Affiliates that sold Shares under Article 51(d)(ii) shall, direct the purchaser to immediately pay to the Investor the sale proceeds accruing from the sale of Shares of the Promoters and the Promoters' Affiliates, up to but not exceeding an amount that will be sufficient to meet the Exit Amount or permit the Investor to set up an escrow mechanism to facilitate the payment to the Investor prior to any payment to the Promoters.
  - (iv) It is agreed between the Parties that notwithstanding the right of the Investor as specified in this Article 51(d), the Promoters may also identify one or more third parties interested in purchasing all of the Shares of the Investor and/ or some or all of the Shares held by the Promoters and/or the Promoters' Affiliates, and indicate such third party to the Investor, but the Investor shall be under no obligation to sell its Shares to such third parties.
- (e) If:
  - (i) the aggregate proceeds of a sale by the Promoters and any Promoters' Affiliates, if applicable, under Article 51(d) are insufficient to pay to the Investor an amount equal to Exit Difference; and
  - (ii) the Promoters or Promoters' Affiliates hold Shares, the Promoters shall, and shall procure that the each of the Promoters Affiliates that hold Shares shall:
    - (A) as soon as is reasonably practicable after the completion of the sale(s) under Article 51(d), use their best endeavours to sell Shares to one or more third parties or the Company; and
    - (B) direct the relevant purchaser to immediately pay to the Investor:
      - a. an amount equal to the Exit Difference; or
      - b. if the proceeds of sale of the relevant Shares are insufficient to pay to the Investor an amount equal to the Exit Difference, the entire proceeds of sale, and the Exit Difference shall be reduced accordingly.

Sales under this Article 51(e) shall be on such arms-length terms as the Promoters, acting reasonably, deems fit.

- (f) The Promoters shall, and shall procure that the Promoters Affiliates shall, sell Shares under Article 51(e) until such time as:
  - (i) the Exit Difference is zero (0); or
  - (ii) no Promoters or Promoters' Affiliate hold Shares,upon which the obligation of the Promoters to sell Shares under Article 51(e) shall cease.
- (g) In the event the Investor receives any amount under Articles 51(d) and/or 51(e) in excess of an amount equal to the Exit Difference, the Investor shall return such excess amount to the Promoters as soon as practicable.
- (h) For the purposes of this Article 51, **Exit Difference** shall mean an amount equal to the amount that the Investor would have received for its Shares had they been sold at the Exit Amount less the amount actually received by the Investor under Articles 51(d) and/or 51(e) (as the case may be), if any, from time to time.

**52. No Pledging Of Investor's Shares**

The Investor shall not be required to pledge or otherwise encumber its Shares in favour of, or provide any other support to, any third party dealing with the Company including, without limitation, lenders to the Company. The Company shall make this fact clear in any discussions or negotiations with such third parties and any financing plans of the Company shall take this fact into account.

**RIGHTS AND LIABILITIES**

**53. Investor's Affiliates Rights And liabilities**

If the Investor has transferred any of its Shares to any Affiliate of the Investor in accordance with the terms of the Shareholders Agreement, then any right may be exercised by the Investor on behalf of themselves and any Affiliate of the Investor that holds Shares from time to time and such exercise shall be valid for the purposes of the Shareholders Agreement. In any case where the Promoters are obliged to make or procure to be made any payment to the Investor and, by virtue of its owning Shares and entering into a Deed of Accession, an Affiliate of the Investor, the Promoters shall be entitled to make such payment or procure that such payment is made to the Investor, whose receipt shall be a good and valid discharge.

**54. Promoters' Liabilities**

The liability of the Promoters under the Shareholders Agreement and the Investment Agreement shall be joint and several. Where any obligation, representation, warranty or undertaking in the Shareholders Agreement is expressed to be made, undertaken or given by two or more of the Promoters, they shall be jointly and severally responsible in respect of it.

**BORROWING POWERS**

**55. Other Covenants**

- (a) Each Shareholder covenants that it shall not, and shall procure that any Affiliate of it shall not (either personally or through an agent), use or disclose or divulge to any third party any information of a secret or confidential nature relating to the business or affairs of the Company (except as required by law or regulation, or to the extent that such information is in the public domain other than through a breach of this Article) provided that the Investor shall be permitted to disclose such information to the Investor's Affiliates and the limited partners of the Investor.
- (b) The Company covenants and undertakes with the Shareholders that it shall comply with its undertakings as set out in the Schedule 4 of the Shareholders Agreement.

**56. In case of any conflict between Part B of these Articles and Shareholders' Agreement, the Provisions of Shareholders' Agreement will prevail.**

## SECTION IX – OTHER INFORMATION

### MATERIAL CONTRACTS AND DOCUMENTS FOR INSPECTION

The following contracts (not being contracts entered into in the ordinary course of business carried on by our Company) which are or may be deemed material have been entered or to be entered into by our Company. These contracts, copies of which were attached to the copy of the Red Herring Prospectus will also be attached in this copy of the Prospectus and delivered to the Registrar of Companies for filing. Also the documents for inspection referred to hereunder, were available for inspection at our Registered Office from 10.00 am to 4.00 pm on Working Days from the date of the Red Herring Prospectus until the Bid/ Offer Closing Date, except for such contracts and documents that will be executed subsequent to the completion of the Bid/Offer Closing Date. Any of the contracts or documents mentioned in this Prospectus may be amended or modified at any time if so required in the interest of our Company or if required by the other parties, without reference to the Shareholders, subject to compliance of the provisions contained in the Companies Act and other applicable law.

#### *Material Contracts to the Offer*

1. Offer Agreement among our Company, the Selling Shareholder (i.e. Rivendell PE LLC) and the BRLMs dated March 17, 2021 and amendment to Offer Agreement dated July 20, 2021.
2. Registrar Agreement among our Company, the Selling Shareholder (i.e. Rivendell PE LLC) and Registrar to the Offer dated March 17, 2021.
3. Escrow and Sponsor Bank Agreement dated July 20, 2021 among our Company, the Selling Shareholder (i.e. Rivendell PE LLC), the BRLMs, the Escrow Collection Bank(s), Public Offer Account Bank(s), Refund Bank(s), the Sponsor Bank and the Registrar to the Offer.
4. Share Escrow Agreement dated July 20, 2021 between the Company, the Selling Shareholder (i.e. Rivendell PE LLC) and the Share Escrow Agent.
5. Syndicate Agreement dated July 20, 2021 among our Company, the Selling Shareholder (i.e. Rivendell PE LLC), the BRLMs and the Syndicate Members.
6. Underwriting Agreement dated August 3, 2021, among our Company, the Selling Shareholder (i.e. Rivendell PE LLC) and the Underwriters.

#### *Material Documents*

1. Certified copies of the Memorandum of Association and Articles of Association of our Company as amended from time to time.
2. Our certificate of incorporation dated February 13, 2003 and certificate of incorporation dated March 10, 2021 consequent to change of our name.
3. Resolutions of the Board of Directors dated March 12, 2021 and July 18, 2021, authorising the Fresh Issue and taking on record the Offer for Sale.
4. Resolution of the Shareholders dated March 12, 2021 under section 62(1)(c) of the Companies Act, 2013 authorising the Offer.
5. Resolution of the Board dated March 17, 2021 approving the Draft Red Herring Prospectus and taking on record the Offer for Sale.
6. Resolution of the Board of Directors dated July 21, 2021, approving the Red Herring Prospectus.
7. Consent letter and authorisation of the board of directors of the Selling Shareholder (i.e. Rivendell PE LLC) for participation in the Offer for Sale, dated July 17, 2021 and July 17, 2021, respectively.
8. Investment Agreement dated September, 2007 entered into amongst our Company, our Promoters,

members of our Promoter Group namely, Ashok Dayashankar Madeka, Paresh Dayashankar Madeka, Mihir Rupeshkumar Madeka, Hemal Paresh Madeka, Sanjay Bhagwanji Bole and Bharat Jiten Madeka and Rivendell PE LLC (formerly NSR-PE Mauritius LLC).

9. Shareholders' Agreement dated September, 2007 entered into between our Company, our Promoters, certain members of our Promoter Group and Investor.
10. Amendment Agreement dated March 12, 2021, entered into amongst our Company, our Promoters, members of our Promoter Group namely, Ashok Dayashankar Madeka, Paresh Dayashankar Madeka, Mihir Rupeshkumar Madeka, Hemal Paresh Madeka, Sanjay Bhagwanji Bole and Bharat Jiten Madeka and Rivendell PE LLC (formerly NSR-PE Mauritius LLC).
11. Master restructuring agreement dated March 28, 2013 entered into by the Company with Corporation Bank, Oriental Bank of Commerce, Union Bank of India, Bank of Baroda, Bank of India, Indian Overseas Bank (collectively, "**Consortium Lenders**").
12. Supplemental restructuring agreement dated November 22, 2013, entered into amongst the Company, the Consortium Lenders and IDBI Bank Limited.
13. Agreement dated June 16, 2015 among NSDL, our Company and the Registrar to the Offer.
14. Agreement dated April 16, 2015 among CDSL, our Company and the Registrar to the Offer.
15. Pledge agreements dated March 28, 2013 and September 24, 2018, respectively, entered into amongst the Company and the Consortium Lenders.
16. Copies of auditor's reports of our Company in respect of our audited financial statements for Fiscal Years 2019, 2020 and 2021.
17. Copies of annual reports of our Company for Fiscal Years 2019, 2020 and 2021.
18. Examination reports of our Statutory Auditors dated July 18, 2021 on the Restated Financial Statements included in the Red Herring Prospectus.
19. Report on Statement of Special tax benefits from our Statutory Auditors, dated July 18, 2021.
20. Industry report titled "Indian Bearings Industry – Industry revenue to witness a smart recovery in FY 2022" dated March, 2021, prepared by ICRA.
21. Written consent dated August 3, 2021 from S R B C & CO LLP, Chartered Accountants, to include their name as required under section 26 (1) of the Companies Act, 2013 read with SEBI ICDR Regulations, in this Prospectus, and as an "expert" as defined under section 2(38) of the Companies Act, 2013 to the extent and in their capacity as our Statutory Auditors, and in respect of their (i) examination report, dated July 18, 2021 on our Restated Financial Statements; and (ii) their report dated July 18, 2021 on Statement of Special Tax Benefits in this RHP and such consent has not been withdrawn as on the date of this RHP. However, the term "expert" shall not be construed to mean an "expert" as defined under the U.S. Securities Act.
22. Consents of the Selling Shareholder (i.e. Rivendell PE LLC), Bankers to our Company, the BRLMs, Syndicate Members, Registrar to the Offer, Escrow Collection Bank(s), Sponsor Bank, Directors of our Company, Company Secretary and Compliance Officer for the Offer, Chief Financial Officer, Babulal A. Ughreja, Chartered Engineer, Public Offer Account Bank(s), ICRA, legal counsel, Special International Legal Counsel to the BRLMs, Refund Bank(s) as referred to, in their respective capacities.
23. Consent letters received from the Consortium Lenders.
24. In-principle listing approvals dated May 4, 2021 and April 19, 2021 received from NSE and the BSE, respectively.
25. Due diligence certificate dated March 17, 2021 to SEBI from the BRLMs.

26. SEBI observation letter SEBI/HO/CFD/DIL2/RD/RP/OW/P/2021/11195/1 dated May 28, 2021 and our in-seriatim reply to the same dated July 19, 2021.

Any of the contracts or documents mentioned in this Prospectus may be amended or modified at any time, if so required in the interest of our Company, or if required by other parties, without notification to the shareholders, subject to compliance with the provisions contained in the Companies Act, 2013 and other relevant statutes.

## DECLARATION

I hereby declare that all relevant provisions of the Companies Act, 2013 and the rules, or guidelines, or regulations issued by the Government of India or the rules, or guidelines, or regulations issued by the Securities and Exchange Board of India, established under section 3 of the Securities and Exchange Board of India Act, 1992, as the case may be, have been complied with and no statement made in this Prospectus is contrary to the provisions of the Companies Act, 2013, the Securities Contracts (Regulation) Act, 1956, the Securities Contracts (Regulation) Rules, 1957, the Securities and Exchange Board of India Act, 1992, as the case may be. I further certify that all statements in this Prospectus are true and correct.

### SIGNED BY DIRECTOR OF OUR COMPANY

---

**Manesh Dayashankar Madeka**  
*Chairman and Managing Director*

**Place:** Rajkot

**Date:** August 3, 2021

## **DECLARATION**

I hereby declare that all relevant provisions of the Companies Act, 2013 and the rules, or guidelines, or regulations issued by the Government of India or the rules, or guidelines, or regulations issued by the Securities and Exchange Board of India, established under section 3 of the Securities and Exchange Board of India Act, 1992, as the case may be, have been complied with and no statement made in this Prospectus is contrary to the provisions of the Companies Act, 2013, the Securities Contracts (Regulation) Act, 1956, the Securities Contracts (Regulation) Rules, 1957, the Securities and Exchange Board of India Act, 1992, as the case may be. I further certify that all statements in this Prospectus are true and correct.

### **SIGNED BY DIRECTOR OF OUR COMPANY**

---

**Bhautik Dayashankar Madeka**

*Whole Time Director*

**Place:** Rajkot

**Date:** August 3, 2021

## DECLARATION

I hereby declare that all relevant provisions of the Companies Act, 2013 and the rules, or guidelines, or regulations issued by the Government of India or the rules, or guidelines, or regulations issued by the Securities and Exchange Board of India, established under section 3 of the Securities and Exchange Board of India Act, 1992, as the case may be, have been complied with and no statement made in this Prospectus is contrary to the provisions of the Companies Act, 2013, the Securities Contracts (Regulation) Act, 1956, the Securities Contracts (Regulation) Rules, 1957, the Securities and Exchange Board of India Act, 1992, as the case may be. I further certify that all statements in this Prospectus are true and correct.

### SIGNED BY DIRECTOR OF OUR COMPANY

---

**Mihir Rupeshkumar Madeka**

*Whole Time Director*

**Place:** Rajkot

**Date:** August 3, 2021



## DECLARATION

I hereby declare that all relevant provisions of the Companies Act, 2013 and the rules, or guidelines, or regulations issued by the Government of India or the rules, or guidelines, or regulations issued by the Securities and Exchange Board of India, established under section 3 of the Securities and Exchange Board of India Act, 1992, as the case may be, have been complied with and no statement made in this Prospectus is contrary to the provisions of the Companies Act, 2013, the Securities Contracts (Regulation) Act, 1956, the Securities Contracts (Regulation) Rules, 1957, the Securities and Exchange Board of India Act, 1992, as the case may be. I further certify that all statements in this Prospectus are true and correct.

### SIGNED BY DIRECTOR OF OUR COMPANY

---

**Pravinchandra Ratilal Dholakia**

*Independent Director*

**Place:** Rajkot

**Date:** August 3, 2021

## **DECLARATION**

I hereby declare that all relevant provisions of the Companies Act, 2013 and the rules, or guidelines, or regulations issued by the Government of India or the rules, or guidelines, or regulations issued by the Securities and Exchange Board of India, established under section 3 of the Securities and Exchange Board of India Act, 1992, as the case may be, have been complied with and no statement made in this Prospectus is contrary to the provisions of the Companies Act, 2013, the Securities Contracts (Regulation) Act, 1956, the Securities Contracts (Regulation) Rules, 1957, the Securities and Exchange Board of India Act, 1992, as the case may be. I further certify that all statements in this Prospectus are true and correct.

### **SIGNED BY DIRECTOR OF OUR COMPANY**

---

**Dipesh Dhirajlal Kundaliya**  
*Independent Director*

**Place:** Rajkot

**Date:** August 3, 2021

## DECLARATION

I hereby declare that all relevant provisions of the Companies Act, 2013 and the rules, or guidelines, or regulations issued by the Government of India or the rules, or guidelines, or regulations issued by the Securities and Exchange Board of India, established under section 3 of the Securities and Exchange Board of India Act, 1992, as the case may be, have been complied with and no statement made in this Prospectus is contrary to the provisions of the Companies Act, 2013, the Securities Contracts (Regulation) Act, 1956, the Securities Contracts (Regulation) Rules, 1957, the Securities and Exchange Board of India Act, 1992, as the case may be. I further certify that all statements in this Prospectus are true and correct.

### SIGNED BY DIRECTOR OF OUR COMPANY

---

**Jignasa Pravinchandra Mehta**  
*Independent Director*

**Place:** Rajkot

**Date:** August 3, 2021

## DECLARATION

I hereby declare that all relevant provisions of the Companies Act, 2013 and the rules, or guidelines, or regulations issued by the Government of India or the rules, or guidelines, or regulations issued by the Securities and Exchange Board of India, established under section 3 of the Securities and Exchange Board of India Act, 1992, as the case may be, have been complied with and no statement made in this Prospectus is contrary to the provisions of the Companies Act, 2013, the Securities Contracts (Regulation) Act, 1956, the Securities Contracts (Regulation) Rules, 1957, the Securities and Exchange Board of India Act, 1992, as the case may be. I further certify that all statements in this Prospectus are true and correct.

### SIGNED BY DIRECTOR OF OUR COMPANY

---

**Ashit Ravishankar Vankani**  
*Independent Director*

**Place:** Rajkot

**Date:** August 3, 2021

## **DECLARATION**

I hereby declare that all relevant provisions of the Companies Act, 2013 and the rules, or guidelines, or regulations issued by the Government of India or the rules, or guidelines, or regulations issued by the Securities and Exchange Board of India, established under section 3 of the Securities and Exchange Board of India Act, 1992, as the case may be, have been complied with and no statement made in this Prospectus is contrary to the provisions of the Companies Act, 2013, the Securities Contracts (Regulation) Act, 1956, the Securities Contracts (Regulation) Rules, 1957, the Securities and Exchange Board of India Act, 1992, as the case may be. I further certify that all statements in this Prospectus are true and correct.

**SIGNED BY CHIEF FINANCIAL OFFICER OF OUR COMPANY**

---

**Hiren Dilipbhai Doshi**

**Place:** Rajkot

**Date:** August 3, 2021

## DECLARATION

I hereby declare that all relevant provisions of the Companies Act, 2013 and the rules, or guidelines, or regulations issued by the Government of India or the rules, or guidelines, or regulations issued by the Securities and Exchange Board of India, established under section 3 of the Securities and Exchange Board of India Act, 1992, as the case may be, have been complied with and no statement made in this Prospectus is contrary to the provisions of the Companies Act, 2013, the Securities Contracts (Regulation) Act, 1956, the Securities Contracts (Regulation) Rules, 1957, the Securities and Exchange Board of India Act, 1992, as the case may be. I further certify that all statements in this Prospectus are true and correct.

### SIGNED BY DIRECTOR OF OUR COMPANY

---

**Vivek Sett**

*Nominee Director*

**Place:** Mumbai

**Date:** August 3, 2021

**DECLARATION BY RIVENDELL PE LLC, AS THE SELLING SHAREHOLDER**

Rivendell PE LLC confirms that all statements and undertakings made or confirmed by it in this Prospectus specifically in relation to itself, as the Selling Shareholder (i.e. Rivendell PE LLC), and the Equity Shares which are being offered by it by way of the Offer for Sale pursuant to the Offer, are true and correct.

**SIGNED FOR AND ON BEHALF OF RIVENDELL PE LLC**

**Name:** Margaret A. Riley

**Designation:** Director

**Date:** August 3, 2021

**Place:** Mauritius